



OWNER'S MANUAL

DISHWASHER



Before beginning installation, read these instructions carefully. This will simplify installation and ensure that the product is installed correctly and safely. Leave these instructions near the product after installation for future reference.

XD5*14**



MFL70282402
Rev.00_121317

www.lg.com

Copyright © 2017 LG Electronics Inc. All Rights Reserved.

TABLE OF CONTENTS

This manual may contain images or content different from the model you purchased.

This manual is subject to revision by the manufacturer.

| | |
|---|-----------|
| SAFETY INSTRUCTIONS | 3 |
| IMPORTANT SAFETY INSTRUCTIONS | 3 |
| INSTALLATION | 10 |
| Specifications | 10 |
| Accessories | 11 |
| Preparing Cabinet Opening | 11 |
| Levelling the Appliance | 12 |
| Installing the Drain Hose | 13 |
| Connecting the Water Supply Hose | 14 |
| Preparing Electrical Wiring | 15 |
| Final Check | 15 |
| OPERATION | 16 |
| Before Using the Appliance | 16 |
| Using the Appliance | 20 |
| Control Panel | 21 |
| Cycles | 22 |
| Cycle Options | 23 |
| Programme Guide | 24 |
| Available Options | 24 |
| Information for Energy Test (AS/NZS 2007) | 25 |
| Loading the Dishwasher | 26 |
| Adding Cleaning Agents | 30 |
| Refilling | 32 |
| Drying | 32 |
| SMART FUNCTIONS | 33 |
| Using LG SmartThinQ Application | 33 |
| Using Smart Diagnosis™ | 34 |
| MAINTENANCE | 35 |
| Cleaning the Exterior | 35 |
| Cleaning the Interior | 35 |
| Cleaning the Filters | 36 |
| Cleaning the Spray Arms | 37 |
| Cleaning the Water Supply Hose Filter | 39 |
| TROUBLESHOOTING | 40 |
| Diagnosing Problems | 40 |
| Error Codes | 44 |

The following safety guidelines are intended to prevent unforeseen risks or damage from unsafe or incorrect operation of the appliance.

The guidelines are separated into 'WARNING' and 'CAUTION' as described below.

 This symbol is displayed to indicate matters and operations that can cause risk. Read the part with this symbol carefully and follow the instructions in order to avoid risk.

 **WARNING**

This indicates that the failure to follow the instructions can cause serious injury or death.

 **CAUTION**

This indicates that the failure to follow the instructions can cause the minor injury or damage to the product.

IMPORTANT SAFETY INSTRUCTIONS

 **WARNING**

To reduce the risk of explosion, fire, death, electric shock, injury or scalding to persons when using this product, follow basic precautions, including the following:

Children in the Household

This appliance is not intended for use by persons (including children) with reduced physical, sensory or mental capabilities, or lack of experience and knowledge, unless they have been given supervision or instruction concerning use of the appliance by a person responsible for their safety. Children should be supervised to ensure that they do not play with the appliance.

Installation

- Never attempt to operate the appliance if it is damaged, malfunctioning, partially disassembled, or has missing or broken parts, including a damaged cord or plug.
- If the power cord is damaged or the hole of the socket outlet is loose, do not use the power cord and contact an authorized service centre.
- Do not modify the power cord provided with the appliance. Please contact the LG Customer information centre to advise of its incompatibility.
- This appliance should only be transported by two or more people holding the appliance securely.
- Do not install the appliance in a damp and dusty place. Do not install or store the appliance in any outdoor area, or any area that is subject to weathering conditions such as direct sunlight, wind, or rain or temperatures below freezing.
- Do not plug multiple socket outlets, an extension power cable or adapter with this appliance.
- Disconnect the power cord, house fuse or circuit breaker before installing or servicing the appliance.
- When moving or installing the product in a different location, call qualified service personnel for installation and service.
- Fix the drain hose securely in place.
- This appliance is not designed for maritime use or for mobile installations such as in RVs, trailers, or aircraft.
- This appliance must be positioned near to an electrical power supply.
- When installing or moving the appliance, be careful not to pinch, crush, or damage the power cord.

- Use new hose or hose-set supplied with the appliance. Reusing old hoses can cause a water leak and subsequent property damage.
- Improper connection of the equipment-grounding conductor can result in risk of electric shock. Check with a qualified electrician or service personnel if you are in doubt as to whether the appliance is properly grounded.
- This appliance must be grounded. In the event of malfunction or breakdown, grounding will reduce the risk of electric shock by providing a path of least resistance for electric current.
- This appliance is equipped with a power cord having an equipment-grounding conductor and a grounding power plug. The power plug must be plugged into an appropriate socket outlet that is installed and grounded in accordance with all local codes and ordinances.
- After installing, check the hose connection for leaks before moving the appliance into the cabinet opening.
- Do not damage or place heavy items on the power cord of the appliance.
- This appliance is intended to be used in household and domestic applications only and must not be used for commercial purposes.
- For a permanently connected dishwasher: This appliance must be connected to a grounded metal, permanent wiring system, or an equipment-grounding conductor must be run with the circuit conductors and connected to the equipment-grounding terminal or lead to the appliance.
- Connect the ground wire to the green ground connector in the terminal box.

Operation

- Immediately unplug the power plug and contact an LG Electronics customer information centre if you detect a strange sound, odour, or smoke coming from the appliance.
- Do not repair or replace any part of the appliance. All repairs and servicing must be performed by qualified service personnel unless specifically recommended in this Owner's Manual. Use only authorized factory parts.
- Do not leave the appliance door open. Children may hang on the door or crawl inside the appliance, causing damage or injury.
- Do not use flammable gas and combustible substances (benzene, gasoline, thinner, petroleum, alcohol, etc.) near the appliance.
- Do not attempt to separate any panels or disassemble the appliance. Do not apply any sharp objects to the control panel in order to operate the appliance.
- Do not bend the power cable excessively or place a heavy object on it.
- Do not put animals, such as pets into the appliance.
- Do not touch the power plug or the appliance controls with wet hands.
- If there is a gas leakage (isobutane, propane, natural gas, etc.), do not touch the appliance or power plug and ventilate the area immediately.
- In case of flood, disconnect the power plug and contact the LG Electronics Customer Information Centre.
- Under certain conditions, hydrogen gas may be produced in a hot-water system that has not been used for two weeks or more. **HYDROGEN GAS IS EXPLOSIVE.** If the hot-water system has not been used for such a period, before using the appliance turn on all hot water tap and let the water flow from each for several minutes. This will release any accumulated hydrogen gas. As the gas is flammable, do not smoke or use an open flame during this time.

- Keep the area underneath and around your appliances free of combustible materials such as lint, paper, rags, chemicals, etc.
- Some dishwasher detergents are strongly alkaline. They can be extremely dangerous if swallowed. Avoid contact with the skin and eyes and keep children away from the dishwasher when the door is open. Check that the detergent receptacle is empty after completion of the wash cycle.
- Do not operate the appliance unless all enclosure panels are properly in place.
- Use only detergents or wetting agents recommended for use in a appliance and keep them out of the reach of children.
- Do not wash and dry articles that have been soaked in explosive substances such as gasoline, solvents, solvent-based detergent.
- When loading items to be washed:
 - Locate sharp items so that they are not likely to damage the door seal.
 - Load sharp knives with the handles up to reduce the risk of cut-type injuries.
- Do not wash plastic items unless they are marked "dishwasher safe" or the equivalent. For plastic items not so marked, check the manufacturer's recommendations.
- Do not touch any heating element (where it is exposed) during or immediately after use.
- Do not abuse, sit on, or stand on the door or dish rack of the dishwasher.
- After cleaning the dishes, turn off the tap. Turn on the tap again and check the connection status of water supply hose before cleaning.
- Do not open the door while the appliance is in operation. Water will splash out and could cause a slipping hazard.
- Be careful not to catch your hand when closing the door of the appliance.
- Do not wash and dry articles that have been soaked in explosive substances such as gasoline, solvents, solvent-based detergent.

- Do not come into contact with any fitted steam outlet.
- Small parts, such as rack clips and filter retaining posts can be a choke hazard to small children if removed from the dishwasher. Keep out of reach of small children.
- Knives and other utensils with sharp points must be loaded in the basket with their points down or placed in a horizontal position.
- The door should not be left in the open position since this could present a tripping hazard.

Maintenance

- Never unplug the appliance by pulling on the power cable. Always grip the power plug firmly and pull straight out from the socket outlet.
- Securely plug the power plug in the socket outlet after completely removing any moisture and dust.
- Do not spray water inside or outside the appliance to clean it.
- Disconnect the appliance from the power supply before cleaning the appliance. Setting the controls to the OFF or stand by position does not disconnect this appliance from the power supply.

Disposal

- Before discarding an old appliance, unplug it. Cut off the cable directly behind the appliance to prevent misuse.
- Dispose of all packaging materials (such as plastic bags and styrofoam) away from children. The packaging materials can cause suffocation.
- Remove the door before disposing of or discarding this appliance to avoid the danger of children or small animals getting trapped inside.

 CAUTION

To reduce the risk of fire, electric shock, or injury to persons when using your product, basic safety precautions should be followed, including the following:

Installation

- Install the product on a firm and level floor.
- Do not put the drain hose under the dishwasher during installation.

Operation

- Turn off the water tap and unplug the appliance if the appliance is to be left for an extended period of time, such as during vacations.
- Do not place objects on the top of the appliance.
- Do not wipe or coat the surface of the product with liquid detergent or bleach (chlorine bleach, oxygen bleach, etc). Failure to follow these instructions may result in corrosion or discoloration of the coating.
- Do not touch water draining from the machine as it may be hot.
- If the drain hose and the water supply hose are frozen in winter, defrost before using.
- Do not put hands, feet, or metal objects below or behind the appliance.
- Do not wash dishes stained with chemical products such as oil, cream or lotions used in a massage parlor, skin care shop, beauty shop or barber shop.

Specifications

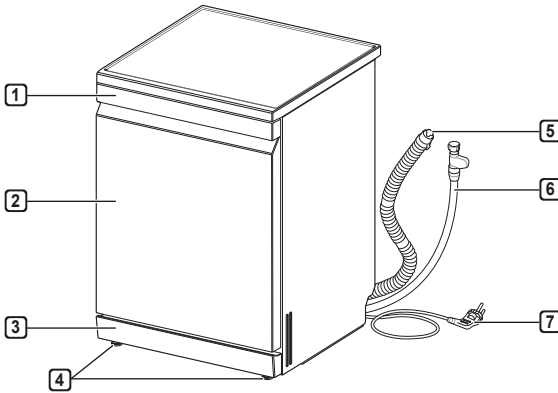

- 1 Control Panel & Door Handle
- 2 Front Cover
- 3 Lower Cover
- 4 Leveling Feet
- 5 Drain Hose
- 6 Water Supply Hose
- 7 Power Cord

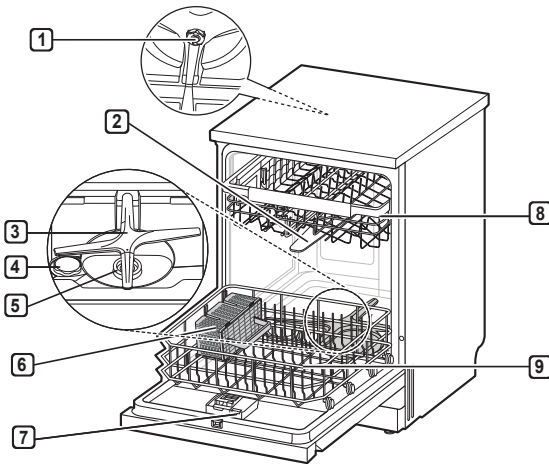

- 1 Top Wash Impeller
- 2 Upper Spray Arm
- 3 Lower Spray Arm
- 4 Salt Container Cap
- 5 Filtration System
- 6 Cutlery Basket
- 7 Detergent and Rinse Aid Dispenser
- 8 Upper Rack
- 9 Lower Rack

- Power supply: 220-240 V~ 50 Hz
- Size: 600 mm (W) X 600 mm (D) X 850 mm (H)
- Product weight: XD5*14** – 47 kg
- Max. capacity: XD5*14** – 14 place settings
- Water feed pressure: 0.05 – 0.6 Mpa
- Power consumption: 1600 – 1800 W
- Appearance and specification is may vary without notice to improve the quality of the appliance.

Accessories



Funnel
(All models)

Preparing Cabinet Opening

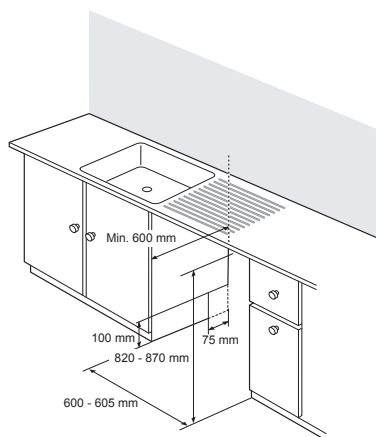

- Cut out for hoses and electrical cables on either side. (Approximately 100 mm X 75 mm)
- Select a location as close to the sink as possible for ease of connection to the water and drain pipes.
- To ensure drainage, the appliance should not be installed more than 1 meter away from the sink.
- If the appliance is installed in a corner, allow minimum clearance of at least 50 mm between the appliance and an adjacent cabinet or wall.
- Before sliding the appliance into the installation opening, all necessary height and height adjustments should be made using a spanner.

⚠ CAUTION

- Any bare wood surrounding the appliance should be sealed with a waterproof paint or sealant to prevent it from swelling.
- Slide the dishwasher into the cabinet, opening carefully. Make sure that the drain hose behind the machine and inside the cabinet is not kinked or stretched.

NOTE

- This installation must be conducted by qualified service personnel to ensure it has been installed correctly.
- Do not pull or lift the appliance using the handle; dosing so can damage the door and hinges. Open the door and grab the body frame and the top front opening of the tub to move or lift the appliance.

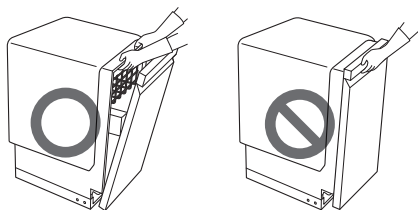

- Do not push the door of the dishwasher with knees.

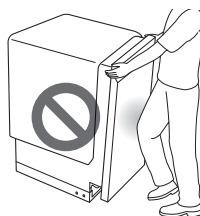

Removing the Top Cover

If the height of the opening is below 850 mm, follow these instructions.

- 1 Remove the 2 screws on the back.

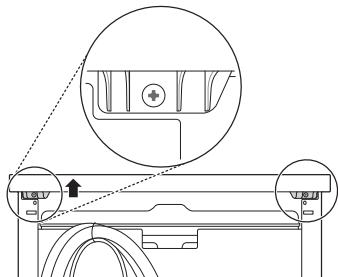

- 2 Pull the top cover backwards after removing the two screws and then lift it up to remove it.

- 3 Remove the locating pins on the top by using a Phillips screw driver.

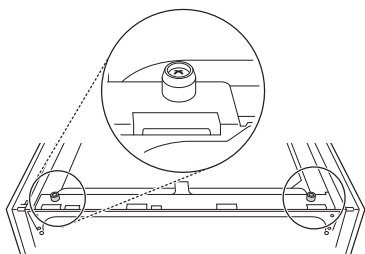

NOTE

- When the appliance is correctly leveled, there should be no slant, stickiness or rubbing sound when the door is opened.

Levelling the Appliance

Levelling the appliance prevents unnecessary leakage and poor washing. Place the appliance on a solid, level floor. Do not install the appliance on an elevated surface.

If the appliance is not properly level, adjust all levelling feet as necessary.

Turn them clockwise to raise and counter-clockwise to lower until the appliance no longer wobbles, both front-to-back and side-to-side and corner-to-corner.

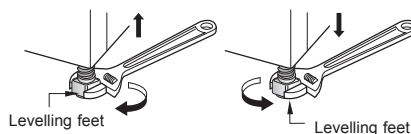

NOTE

- The appliance is not level if there is a rubbing sound or stickiness when the door is opened.

Case 1. The Door is Slanted to the Right

- 1 Unscrew (counter-clockwise) the rear left leg and correct the level.
- 2 Check the opening of door and repeat if necessary until the door opens and closes properly.

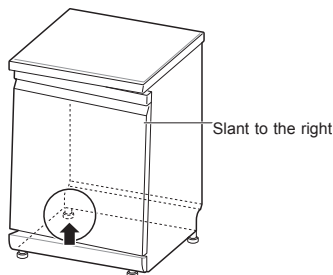

Case 2. The Door is Slanted to the Left

- 1 Unscrew (counter-clockwise) the rear right leg and correct the level.
- 2 Check the opening of door and repeat if necessary until the door opens and closes properly.

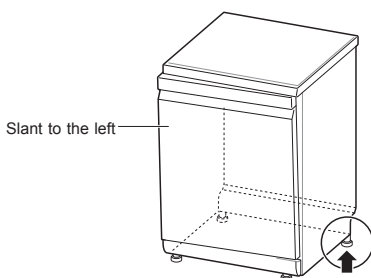

Installing the Drain Hose

If the end of the drain hose does not fit to the drain line, use a drain extension kit (optional) that is resistant to heat and detergent.

This should be available from a plumbing shop or a hardware store.

Connection to the Waste Spigot

Check the waste spigot when initially installing. An **OE** error can occur when the waste spigot below the sink is not drilled out properly. To connect the drain hose, drill out at least a 15 mm diameter hole in the waste spigot before connecting and securing.

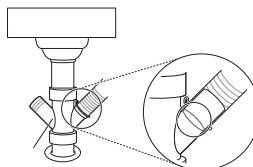

Waste spigot

⚠ CAUTION

- Make sure that plastic debris is not remaining inside of spigot after it has been drilled out.
- Do not attempt to open the waste hole with a screwdriver and hammer. This will induce debris to become stuck and cause a malfunction.
- Caution should be taken when passing hoses through Cabinetry holes as they may have sharp edges and could damage the hoses. Smooth or sand edges to avoid damaging the drain or inlet hose.

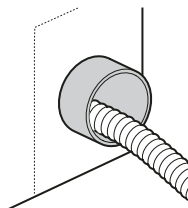

- Make sure that the line is not kinked or sharply bent.

To prevent siphoning, one of the following methods must be used.

Method 1

When the drain hose is connected to a waste spigot, the hose must be looped up to the underside of the bench top and secured.

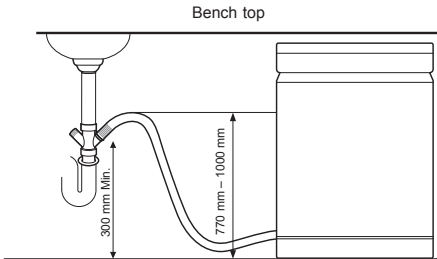

Method 2

When the drain hose is connected to a separate standpipe, it is essential that an airtight connection be made. If not, it can induce odors.

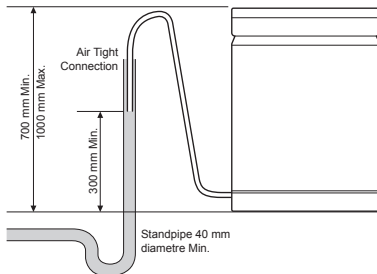

Connecting the Water Supply Hose

Connect the water supply hose to the water tap.

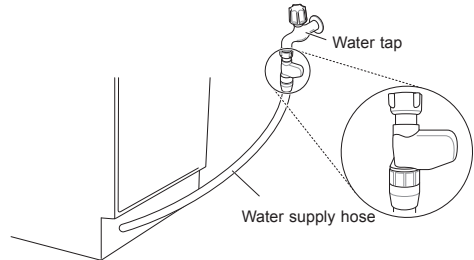

⚠ WARNING

- Do not shorten or damage the water supply hose as it contains electrical wires and components. It can not be detached or removed from the appliance for installation purposes.
- It is important that the water supply hose not be tampered with, cut, disassembled, pulled, or kinked. It contains electrical wiring inside and if damaged, can cause an electrical hazard.

⚠ CAUTION

- This appliance may be fed with either hot or cold water. If the water connection can not be maintained below 65°C, the appliance must be connected to cold water.
- Use sealant tape or sealing compound on the tap's thread to avoid water leaks.
- Make sure that the line is not kinked or sharply bent.

NOTE

- Before connecting the water supply hose to the tap, turn on the tap to flush out foreign substances (dirt, sand or sawdust) in the water lines. Let water drain into a bucket.
- It takes about 3 – 4 minutes for the first supply water.

Preparing Electrical Wiring

Connect the appliance to an earthed socket in accordance with the current wiring regulations, protected by a minimum 15 amp circuit breaker or time delay fuse.

Wiring must be two wires with earth.

The power cord should not be positioned behind the appliance but within 1.2 meters of the side so that the plug is easily accessible.

WARNING

- For personal safety, remove house fuse or open circuit breaker or switch off power plug before installation.
- Do not use an extension cord or double adapter.
- The plug must be plugged into an appropriate outlet that is properly installed and grounded in accordance with all local codes and ordinances.
- Repairs to the appliance must only be carried out by qualified service personnel. Repairs carried out by inexperienced persons may cause injury or serious malfunctioning. Contact our local service centre.
- Connect to a properly rated, protected, and sized power circuit to avoid electrical overload.

Final Check

- 1 Turn on electrical power.
- 2 Turn on house water supply.
- 3 The door should open and close smoothly and without harsh noises, if the unit has been leveled correctly.
- 4 Run the appliance on a Rinse cycle to verify proper operation and check for leaks.

| Error Code | Possible Cause and Solution |
|------------|--|
| OE Error | <p>Drain hose kinked or pinched.</p> <p>Feed the drainage and supply hoses through the hole under the sink. Then gradually slide the dishwasher into the cabinet while pulling on the hoses under the sink to take up any slack. This helps avoid kinking the hoses or trapping them beneath the dishwasher.</p> |
| | <p>Waste spigot under sink is clogged.</p> <p>Drill out the waste spigot under the sink.</p> |
| IE Error | <p>Water supply line kinked under dishwasher.</p> <p>Feed the drainage and supply hoses through the hole under the sink. Then gradually slide the dishwasher into the cabinet while pulling on the hoses under the sink to take up any slack. This helps avoid kinking the hoses or trapping them beneath the dishwasher.</p> |
| | <p>House water supply not turned on.</p> <p>Turn water on. Water pressure may be too high or too low.</p> |

Before Using the Appliance

This model has a water softener to soften hard water.

NOTE

- The appliance can be used without appliance salt if not required, however, the hardness level needs to be set to H00 so that the icon does not remain lit.
- In order to provide satisfactory rinsing results, the appliance requires soft water, i.e., containing little or no lime, otherwise water stains will be left behind on the dishes and inside the appliance.
- If the tap water exceeds a certain level of hardness, it must be softened, i.e., decalcified. This is achieved by adding appliance salt to the water softener inside the appliance. The required amount of the salt is set up according to how hard tap water is.

Checking Water Hardness Level

Method 1

- 1 Check the water hardness in your area. The water utility company can help you with this.
- 2 Set the softening system level of the appliance according to the water hardness level.

Method 2

You can check water hardness by using the test strip included in the product.

- 1 Immerse all reaction zones of the test strip for about a second. Do not in running water.
- 2 Shake off excess liquid from the strip and wait for 1 minute.
- 3 Check the water hardness color from the strip. Refer to the wrapper.

Water Hardness Table

| The value of hardness | Hardness range | | | | | Water quality | Softening system level |
|-----------------------|----------------|-----------|---------|----------------|-----------|---|------------------------|
| | °d | °e | °f | mmol/l (Ca+Mg) | mg/l Ca | | |
| 0 | <4 | <5 | <7 | <0.7 | <29 | Soft | H0 |
| 75 | 4 - 7 | 5 - 9 | 7 - 13 | 0.7 - 1.3 | 29 - 50 |  | H1 |
| 125 | 7 - 14 | 9 - 17.5 | 13 - 25 | 1.3 - 2.5 | 50 - 100 | | H2 |
| 250 | 14 - 21 | 17.5 - 26 | 25 - 38 | 2.5 - 3.8 | 100 - 150 | | H3 |
| 375 | >21 | >26 | >38 | >3.8 | >150 | Hard | H4 |

Setting the Water Softening System

For effective washing performance, adjust the setting corresponding to the hardness level of water used in water supply. The water softener has 5 adjustment levels, and the appliance is programmed at the factory for a water hardness level of H0. You can check the default setting value and adjust it in the following steps:

- 1 Press **Power** and **Half Load** button simultaneously.
 - Current setting value indicated.
- 2 Press the **Delay Start** button, and then set up the intended value.
 - Scope of setting value is H0 to H4.
- 3 Press the **Start** button to save the setting.
 - The power turns off after saving.

NOTE

- The **Salt refill**  icon turns on in the display if appliance salt is not in the softening system.
- If the hardness setting is set to H0, no icon indicates in spite of no salt.

Filling with Dishwasher Salt

The Dishwasher Salt tank must be filled before starting the washing programme. In case of insufficient salt, the **Salt refill**  icon indicates on the display, unless the hardness level has been set to H0.

⚠ CAUTION

- Once you have filled with appliance salt you must run the Rinse cycle immediately to remove the salt and the salt water around the inner tub in order to prevent corrosion.
- 1 Remove the lower rack and remove the cap of the salt container located on the left side of the filters.
 - 2 Before using the appliance for the first time, it is necessary to pour 1.0 kg of appliance salt and 1 litre of water at the same time if intending to use the water softener system. When refilling the salt, use a funnel. Refer to Before Using the Appliance section.



- 3 Refit the cap tightly.
- 4 Run the Rinse cycle without dishes.

Salt Refill Cycle (1.5 kg for each load)

| | H1 | H2 | H3 | H4 |
|--------|-----|----|----|----|
| Cycles | 100 | 30 | 20 | 10 |

- Cycle may vary on the salt refill amount.

⚠ CAUTION

- Do not pour any detergent in the water softener. It will cause a malfunction.
- Wipe off any spilled salt around the water softener cap.
- Seal the cap properly by aligning it horizontally and turning it clockwise. A loosely fitted cap may cause the salt solution to leak from the compartment back into the tub and cause corrosion.

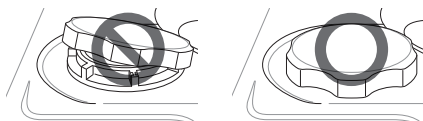

NOTE

- The salt can be purchased from salt distributors.

Adding Rinse Aid

The **Rinse Aid** indicator appears in the display when more rinse aid is needed.

The use of rinse aid is recommended to prevent water spots on dishes and to enhance drying performance.

- 1 Open the rinse aid lid by lifting up the flap.

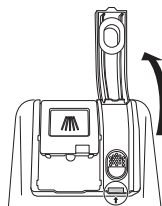

- 2 Add a liquid rinse aid to the maximum fill level. The rinse aid should be settled in the dispenser while filling, or air bubbles may result in poor drying performance. Avoid overfilling the dispenser.

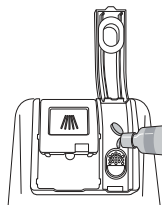

- 3 Close the lid to lock the dispenser. Rinse aid is dispensed automatically during the final rinse cycle.

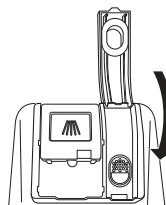

CAUTION

- Rinse aid must not be added if dish washing tablets are used which contain a built in rinse aid.
- Wipe off any spilled rinse aid to prevent suds.

NOTE

- Only use liquid rinse aid in the appliance.
- Do not overfill the rinse aid dispenser.
- Too much or too little rinse aid can inhibit the drying performance.

Setting the Rinse Aid Level

The dispenser has five adjustment levels. The appliance is programmed at the factory for a rinse aid dispenser level of 2. This can be checked and altered by using the buttons on the control panel.

- 1 Ensure the appliance is off.
- 2 Press **Power** and **Dual Zone** simultaneously to check the current setting.
- 3 Press **Delay Start** to change the rinse aid dispenser setting. Each press of the button changes the setting one step from LO(off) to L4.
- 4 Once the desired rinse aid dispenser setting is selected, press **Start** to save.

CAUTION

- If the rinse aid lid is not closed properly, a large amount of rinse aid will release into the tub and cause washability problems.

NOTE

- The **Rinse aid refill**  icon will illuminate when more rinse aid is needed.
- If you notice cloudy spots, streaks or water marks on the glassware after washing, increase the setting level.
- Setting the control too high can cause foaming, which will cause poor wash performance.
- If the glass is smeared or foam is present on the bottom, decrease the level setting.
- Setting the rinse aid control too low can cause spotting and streaking on dishes and poor drying performance.



Using the Appliance

1 Press the Power button.

The unit will turn on. Check the indicators.

2 Check that there is rinse aid and appliance salt present.

Refill the rinse aid and the salt, if the corresponding icons illuminate. For more information, refer to Refilling section.

-  : Salt refill icon
-  : Rinse aid refill icon

3 Open the door and check the filters.

Always clean the filter either after a wash or before a wash so that it does not impair the washing performance.

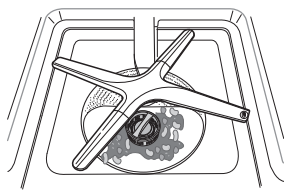

4 Ensure the spray arms can unobstructedly rotate.

Ensure that the upper spray arms and the lower spray arms rotate well. Remove the spray arm and clean it if it does not rotate.

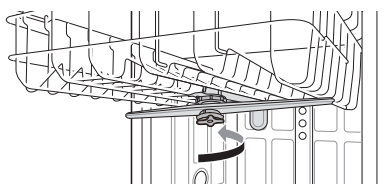

5 Load the dishes in the rack.

Make certain that no dishes or utensils are in the path of the spray arms.

Do not place one dish on top of another.



6 Add the proper amount of detergent powder to the dispenser.

If using Tablets, they can simply be placed directly on the base of the tub, or on the lower part of the inner door.

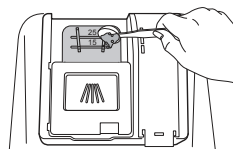

7 Set and start the programme.

The programme will start automatically in 4 seconds after any setting is selected.

WARNING

- Do not load any items in upper rack when the lower rack is pulled out and loaded. Failure to do so may result in injury as the appliance could become unbalanced and topple over.
- Push the upper rack in all the way.
- Empty the lower rack first and then the upper one. It will avoid water dripping from the upper rack onto the dishes below.
- Do not open the door during operation or right after it has completed the wash cycle as the steam may cause scalding as the door is opened.

NOTE

- Never use liquid dishwashing detergent in the appliance.

Control Panel

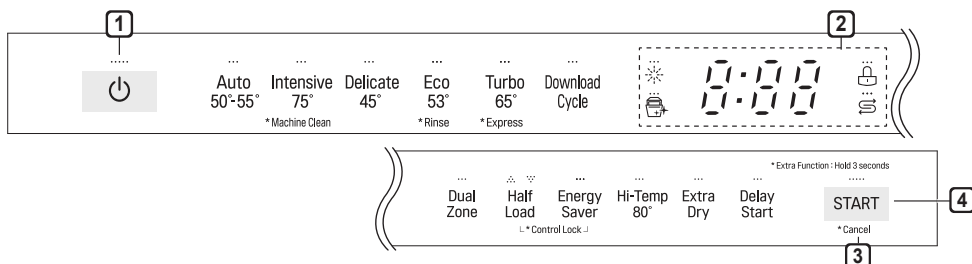

- Depending on the model, the logo and may be located either on the front of the appliance or the top of the door.

1 Power

- Briefly touch **Power** button to turn power on and off.
- After the cycle is complete, the power automatically turns off for purposes of safety and economy.
- If there is a power surge, power outage, or disruption of any kind, power is automatically turned off for safety.
- When power is connected again, it will turn on automatically and resume the cycle.

2 Display

- : Digital Display
 - The digital display on the control panel shows the ESTIMATED cycle time. When the cycle and options are selected, the display shows the total estimated time to complete those selections. During operation, the display shows the remaining estimated operating time.
 - The estimated time shown on the display does not include delay times for heating water, etc.
 - If **Delay Start** is selected, the display shows the delay time in hours.
 - The **Auto** cycle time may vary depending on the soil level of your load.
- : Rinse Aid Icon
 - This icon illuminates when the rinse aid level is low. The LED automatically shuts off when the rinse aid is refilled or the level is set to 0.

- : Machine Clean Icon
 - This icon flashes after every 30 cycles, and while the Machine Clean cycle is running.
 - To activate or deactivate the icon, press the **Intensive** button for 3 seconds.
- : Control Lock Icon
 - This icon illuminates when the control lock feature is activated.
- : Salt refill Icon
 - This icon illuminates when the salt level is low. The LED automatically shuts off when the salt is refilled.

3 Cancel

- The drain pump activates and the cycle cancels. Once the appliance finishes draining, the power turns off.
- Press and hold **Start** button for 3 seconds to activate the cancel function.

4 Start

- To operate the appliance, close the door and press **Start** button.
- If **Start** button is not pressed to start the cycle within 4 minutes, the power will automatically turn off.

Chime On/Off

- To activate or deactivate the button sounds, press and hold **Dual Zone** and **Energy Saver** simultaneously for 3 seconds. The error alert sound cannot be turned off.

Cycles

Auto

This cycle senses the soil amount and water clarity and optimizes the wash to achieve the best cleaning. The wash time may vary depending on the soil level.

Intensive

This cycle is for heavily soiled dishes and dishes with hardened on soil. The Heavy cycle defaults to the strongest spray intensity and uses it to wash heavily soiled dishes.

Delicate

Use this cycle to clean delicate items such as fine china and stemware.

Eco

- It provides the most efficient energy and water consumption for a good washing performance and drying result on a normally soiled load and as it uses very little energy.
- Eco cycle and the Energy Saver option are suitable for a normally soiled load.

Turbo

This cycle will clean moderately soiled dishes using slightly more energy and water.

- **Extra Dry** is set to on as default. If you do not want to dry dishes after washing, turn off the **Extra Dry** option. Not drying the dishes will result in a shorter cycle time.

Download Cycle

Use a dedicated cycle downloadable via NFC.

NOTE

- Only the cycle code for the currently downloaded cycle appears on the appliance. See the smartphone app for cycle codes, names, and more information about the available cycles.
- Default Cycle: P1. Pots & Pans

Machine Clean

This cycle is for cleaning the inside of the appliance. Use the cycle without dishes in the appliance. It eliminates residual soils, odor, white spots, and other dirt. Add citric acid or another cleaning agent for more effective results.

- Press and hold **Intensive** for 3 seconds to activate.

Rinse

This cycle is a quick rinse only for dishes that will not be washed immediately. The cycle rinses dishes that have excess soil to soften dried on residue. Rinsing the dishes helps prevent odors in the appliance. Do not use detergent with the Rinse function.

- This cycle does not have drying.
- Press and hold **Eco** for 3 seconds to activate.

Express

This cycle will quickly clean lightly soiled dishes.

- This cycle does not have drying. Select the **Extra Dry** option or another cycle for better drying. **Extra Dry** will add to the overall cycle time.
- Press and hold **Turbo** for 3 seconds to activate.
- Detergent tablets are not recommended for use of **Express** cycle. If the detergent tablets are used, it may cause detergent residue on dishes due to the relatively low rinse temperatures.



Cycle Options

Select the desired cycle button and then select the options for that cycle. For more information about Cycle Options, see the Available Options section.

Dual Zone

This option automatically sets the spray intensity to soft for the upper spray arm and strong for the lower spray arm. Place heavily soiled dishes like plates and bowls in the lower rack and lightly soiled dishes like cups and small plates in the upper rack to get the best results.

Half Load

This option washes intensively by selecting the upper or lower racks. For small loads, use just the upper or lower rack to save energy and time. By pressing the **Half Load** button, the settings (Upper)  (Lower)  and the cancellation of the Half Load option are available.

Energy Saver

This option saves energy by reducing the wash and rinse temperatures. Wash time is increased to maintain wash performance. Do not use this cycle with heavily soiled dishes.

High Temp

Raises the main wash or heating rinse temperature to improve cleaning.

- A chime will sound to alert you of any residual temperatures inside the appliance. Wait for the appliance to completely cool down before opening the door.

Extra Dry

Select the **Extra Dry** option for better drying performance. This option adds Extra Drying time to the cycle and raises the heated rinse temperature.

- When the rinse aid is empty, the **Extra Dry** option is selected automatically.

Delay Start

The Delay Start feature delays the start of a selected cycle. Each time the **Delay Start** button is pressed, the delay time increases by an hour. The delay time can be set from 1 to 12 hours, in one-hour increments.

- To cancel the Delay Start, turn the power off.
- To change the cycle and cycle option, open the door and then select another cycle and cycle option. The countdown will continue.

Control Lock

The Control Lock feature helps prevent settings from being changed during a cycle. Selecting this feature locks all of the buttons, except for the **Power** button, on the control panel. This feature does not lock the door.

- On models with the external display, while a cycle is running, press and hold **Half Load** and **Energy Saver** simultaneously for 3 seconds to activate or deactivate Control Lock. On models with a concealed display, open the door during operation and follow the same instruction.
- When the Control Lock feature is activated, the display code **CL** will show on the display.
- To start a new cycle, deactivate Control Lock.
- Control Lock button can be set at any time by turning on the appliance.

Programme Guide

| Programme | Soil Level | Wash | | Rinse | | Dry |
|----------------------|------------|-----------------------|---------------------------------------|-----------------------|----------------------------------|-----------------------|
| | | Pre wash | Main wash | Rinse | Heating rinse | |
| Auto | All levels | <input type="radio"/> | <input type="radio"/> (50 - 55 °C) | <input type="radio"/> | <input type="radio"/> (70 °C) | <input type="radio"/> |
| Intensive | Heavy | <input type="radio"/> | <input type="radio"/> (75 °C) | <input type="radio"/> | <input type="radio"/> (70 °C) | <input type="radio"/> |
| Delicate | Light | <input type="radio"/> | <input type="radio"/> (45 °C) | <input type="radio"/> | <input type="radio"/> (60 °C) | <input type="radio"/> |
| Eco | Moderate | <input type="radio"/> | <input type="radio"/> (53 °C) | <input type="radio"/> | <input type="radio"/> (70 °C) | <input type="radio"/> |
| Turbo | Moderate | <input type="radio"/> | <input type="radio"/> (65 °C) | <input type="radio"/> | <input type="radio"/> (65 °C) | |
| Express | Light | <input type="radio"/> | <input type="radio"/> (45 °C) | <input type="radio"/> | <input type="radio"/> (60 °C) | |
| Rinse | Light | <input type="radio"/> | | <input type="radio"/> | | |
| Machine Clean | | <input type="radio"/> | <input type="radio"/> (50 °C) | <input type="radio"/> | <input type="radio"/> (70 °C) | <input type="radio"/> |

- Running time may vary according to the water temperature, water pressure and voltage.

Available Options

| Programme | Options | | | | | |
|-----------------------|-----------------------|-----------------------|-----------------------|-----------------------|-----------------------|-----------------------|
| | Dual Zone | Half Load | Energy Saver | High Temp | Extra Dry | Delay Start |
| Auto | <input type="radio"/> | <input type="radio"/> | <input type="radio"/> | <input type="radio"/> | <input type="radio"/> | <input type="radio"/> |
| Intensive | <input type="radio"/> | <input type="radio"/> | | <input type="radio"/> | <input type="radio"/> | <input type="radio"/> |
| Delicate | | <input type="radio"/> | <input type="radio"/> | | <input type="radio"/> | <input type="radio"/> |
| Eco | <input type="radio"/> | <input type="radio"/> | <input type="radio"/> | <input type="radio"/> | <input type="radio"/> | <input type="radio"/> |
| Turbo | <input type="radio"/> | | | <input type="radio"/> | <input type="radio"/> | <input type="radio"/> |
| Express | <input type="radio"/> | | | <input type="radio"/> | <input type="radio"/> | <input type="radio"/> |
| Rinse | | | | | | <input type="radio"/> |
| Machine Clean | | | | | | <input type="radio"/> |
| Download Cycle | | | | | | <input type="radio"/> |

- The **Energy Saver** option is not available with the **High Temp** or **Extra Dry** option.

Information for Energy Test (AS/NZS 2007)

Appliance loaded in accordance with standard specifications.

- Model : XD5*14**
- Capacity: 14 place settings
- Comparability course: Eco + Energy Saver
- Rinse Aid setting: L4
- Reference cleaner: 27.5 g of detergent onto the inside surface of the door and 5 g of detergent into the dispenser.
- Door is opened at the end of the drying cycle for the drying performance test. (Door position: Open 50 mm)
- Height-adjustable Rack-U position: uppermost

Cutlery Basket

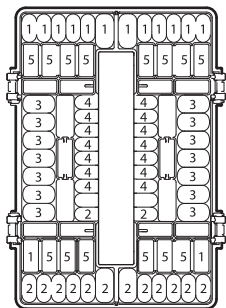
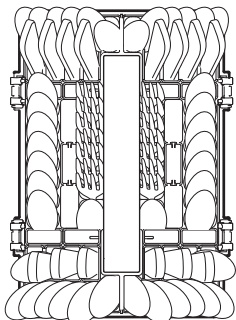

Upper Rack

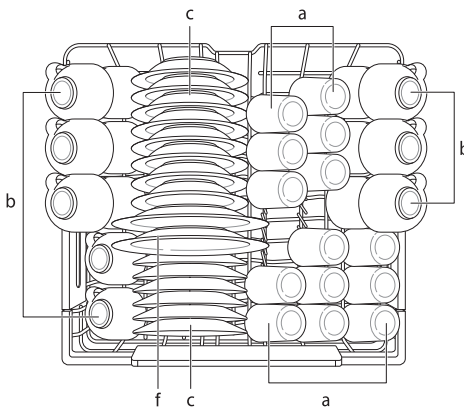

- a** Glasses
- b** Cups
- c** Saucers
- d** Dessert plates

Lower Rack

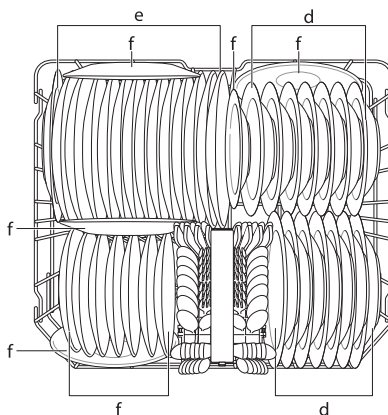

- e** Soup plates
- f** Dinner plates
- d** Dessert plates

Loading the Dishwasher

For effective washing performance, always follow the instructions.

- Remove large particles of food debris from plates including bones etc. before loading. Always rinse off plates when loading if they are not to be washed immediately.
- Items with burnt on food should be soaked prior to loading in the appliance.
- Deep based items should be placed upside down.
- Plastic items will not dry well, compared to other items.
- Make sure that all items do not touch each other.



Non appliance safe items

The combination of high water temperature and appliance detergents may damage certain items. Do not wash the following items.

- Copper or anodised aluminium
- Hand painted silver or gold leaf crockery
- Wood or bone handled utensils
- Iron or non rust proof utensils
- Plastic items which are not appliance safe
- Expensive ware such as silver and dishes with golden rings
- Fragile item such as crystal glasses

⚠ CAUTION

- Do not place pots or pans with plastic handles in the appliance as the handles may deteriorate due to the heat and detergent.
- Water proof or long lasting lipstick smudges on glasses may not be removed during the wash.

Loading the Lower Rack

Daily Use Load

The lower rack is suitable for dinner plates, soup bowls, dishes, pots, pans, lids and even a grill tray.

Plates should be positioned upright and facing the centre of the rack and pots, pans and large dishes must be turned upside down.

To make it easier to load larger dishes, the front row of tines can be folded down.

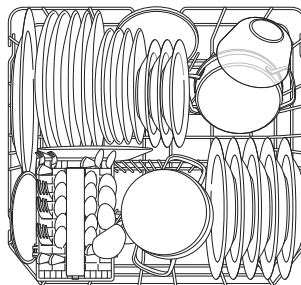

⚠ CAUTION

- Do not obstruct the rotation of the spray arms.

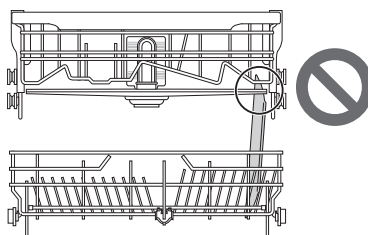

Folding Down the Rack Tines (Optional)

Fold tines down to fit larger dishes; pull tines back up to fit smaller dishes.

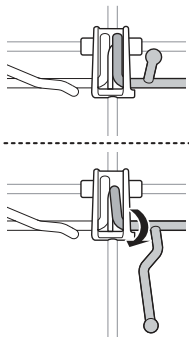

The cup racks provide support for long steam glasses.

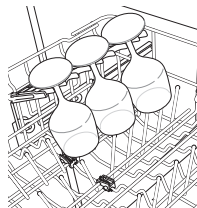

The left side row of tines can be folded down or the cup racks can be folded up out of the way for tall crockery items.

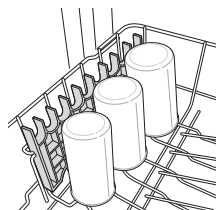

Loading the Upper Rack

Daily Use Load

The upper rack is suitable for delicate items such as, small plates, long cutlery, cups, glasses and appliance safe plastic items.

Cups, glasses and bowls must be positioned upside down.

Plates should be positioned upwards with the plate.

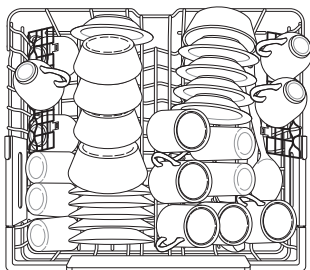

⚠ CAUTION

- Do not obstruct the rotation of the spray arms.

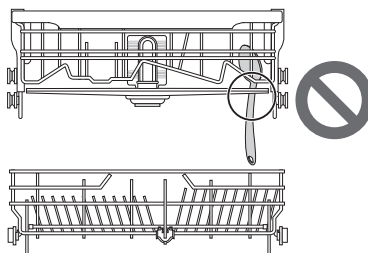

Removing and Replacing Cup Racks

The left and right cup racks are interchangeable and can be removed.

- 1 Slide cup rack down into its closed position.

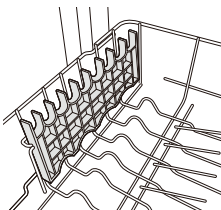

- 2 Locate assembly slot on cup rack and firmly pop rack off support bar on that side.

- The rack on the left pops free at the back. The rack on the right pops free at the front.

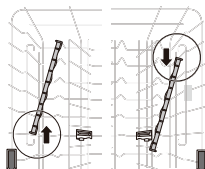
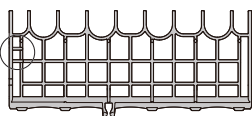

- 3 Slide cup rack off support bar on opposite side.

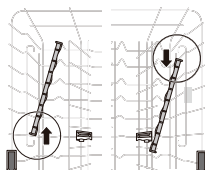

- 4 Reverse instructions to replace cup rack.

Height Adjustable Upper Rack

The upper rack adjusts up and down. Raise the upper rack to allow items up to 300 mm tall in the lower rack. Lower the upper rack to allow dishes up to 215 mm tall in the upper rack on the 2 rack models and 165 mm on the 3 rack models. The appliance ships with the upper rack raised.

There are three available positions for adjusting the height of the upper rack to create more space.

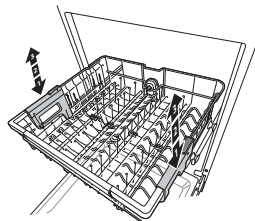

Lowering the Rack

Hold the rack at the centre of each side to support its weight. Then, push the button on each side to release the rack and lower it to the lower position.

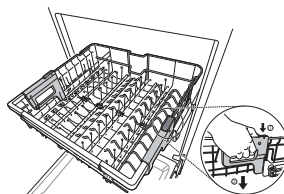

Raising the Rack

Lift the rack at the centre of each side until the rack locks into place in the upper position. It is not necessary to lift the lock levers to raise the rack.

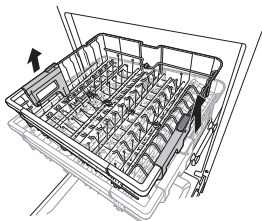

Possible plate size according to the upper rack position

| Upper Rack Position | Plate Size (mm) | |
|---------------------|-----------------|------------|
| | Upper Rack | Lower Rack |
| Upper | 215 | 300 |
| Middle | 240 | 275 |
| Lower | 265 | 250 |

WARNING

- Before adjusting, ensure the rack is empty of all dishes. Otherwise dishes may get damaged or you may get injured.

NOTE

- Before pushing the upper rack into the appliance, ensure the rack height is the same on both sides. If the height is not the same on both sides, the appliance door will not shut and the upper spray arm will not connect to the water inlet.
- Raise the upper rack without pushing the buttons on each side. Pushing the buttons when raising the rack will prevent the rack from locking into position.

- To set the rack to the middle position, it may be easier to lower the rack all the way down and then raise each side of the rack individually until it clicks into place.

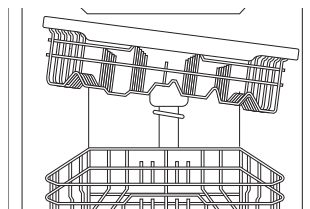

- There is a 56 mm gain in height when the upper rack is moved to the lower position.
- After adjusting the rack levels, check that the spray arms are free to rotate.
- With the lower position of the upper rack, check if the bottom part of upper rack including spray arm is not disturbing items on the lower rack.
- When the upper rack is in the lower position, push in the upper rack first, and the lower rack later.
- Pull out the lower rack first, and the upper rack later.
- Raise the upper rack without pushing the buttons on each side. Pushing the buttons when raising the rack will prevent the rack from locking into position.
- When the upper rack is in the lower position, the possible height of dishes differs depending on the 3rd rack.
- When the upper rack is in the lower position, the possible height of dishes differs with models where the cutlery rack is fitted.

Loading the Cutlery Basket

Daily Use Load

For Large utensils, such as whisks, the cover can be opened by being unhinged.

Place forks and spoons in the cutlery basket with their handles downwards.

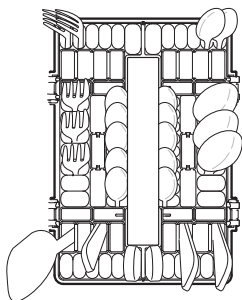

⚠ WARNING

- To prevent injuries, place knives and other utensils with sharp points on the cutlery basket.
- If you want to load them in the cutlery basket, place them with the pointed edges facing downwards.

⚠ CAUTION

- Do not obstruct the rotation of the spray arms.
- The cutlery shouldn't be longer than 18 cm.

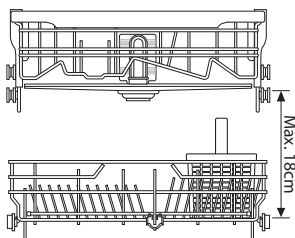

Adding Cleaning Agents

Adding Detergent to the Dispenser

- The amount of detergent needed depends on the cycle, load size, and soil level of dishes.
- Put detergent into the detergent compartment before starting any cycle, except the Rinse cycle.

- 1 Push the button on the dispenser lid to open the cover.

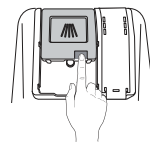

- 2 Add dishwashing detergent to the main wash compartment until the level is between the lines marked 15 and 25.

- Fill to over the 25 line for hard water or heavily soiled loads.
- Fill to the 15 line for soft water or lightly soiled loads.

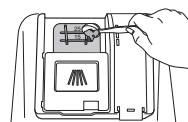

- 3 Push the detergent lid to slide the lid closed until it clicks.

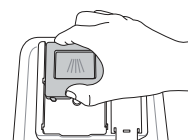

- 4 If a prewash is desired, fill the recessed prewash compartment area on the lid with detergent.

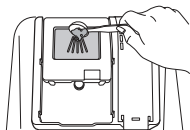

| Programme | Amount of detergent | |
|-----------------------|----------------------------|--------------------------|
| | Pre wash (onto the lid) | Main wash (dispenser) |
| Auto | 5 g | 20 g |
| Intensive | 5 g | 30 g |
| Delicate | 5 g | 20 g |
| Eco | - | 25 g |
| Turbo | 5 g | 20 g |
| Download cycle | 5 g | 20 g |
| Machine clean | 5 g | 20 g |
| Rinse | - | - |
| Express | - | 20 g |

WARNING

- Dishwasher detergent and rinse aid contain chemical components, like all other household detergent. So, they must be kept out of the reach of children.

CAUTION

- Use only detergent intended for dishwashers. Incorrect detergent may cause the appliance to fill with suds during operation. Excess suds may reduce wash performance and may cause the appliance to leak.
- To avoid damaging the appliance, do not pull up on the dispenser to close the appliance door.



- Do not use the liquid rinse aid if the detergent tablets also include a built in rinse aid.
- Use of an unsuitable detergent and rinse aid may result in a risk of damage, corrosion, poor washing performance, poor drying or leakage.

NOTE

- Too much detergent can leave a film on dishes and in the appliance, resulting in poor wash performance.
- After washing, check whether the detergent was completely washed out.
- Some appliance detergent tablets may become stuck in the dispenser due to their excessive size. Tablets can be placed onto the base of the wash tub next to the filter before starting the cycle.
- Never use liquid dishwashing detergent in the appliance.
- Detergent tablets are not recommended for use of **Express** cycle. If the detergent tablets are used, it may cause detergent residue on dishes due to the relatively low rinse temperatures.

Refilling

To maintain the effective wash performance of the appliance, check and refill dishwasher salt regularly.

To maintain the effective dry performance of the appliance, check and refill rinse aid regularly.

Checking the Rinse Aid

When the **Rinse aid refill**  icon illuminates lit, it means the rinse aid is almost empty. If necessary, refill the rinse aid chamber.

Checking the Dishwasher Salt

After refilling the appliance salt, a wash programme should be operated without dishes, as any spilled salt inside the appliance may cause rust or damage to the appliance if the left unwashed.

When the **Salt refill**  icon illuminates, it means the salt is almost empty. If necessary, refill the salt chamber.

CAUTION

- Do not add detergent or any other solution into the water softener housing other than appliance salt. Doing so will cause the water softening system to malfunction.

Drying

- Plastic items may cause poor drying performance compared to other items.
- To assist drying, the door can be opened for a short period of time after the cycle has completed instead of allowing the Cd mode to finish.

NOTE

- Make sure that all items do not touch each other.
- If dry performance is not good or water stains remain, add the Extra Dry option or set the rinse level.
- When using tablet type (2 in 1, 3 in 1) detergent, an additional rinse may be required, depending on the volume of dishes, in this case use the Extra Dry option or set the rinse level.

Using LG SmartThinQ Application

Installing LG SmartThinQ

Search for the LG SmartThinQ application from the Google Play Store or Apple App Store on a smart phone. Follow instructions to download and install the application.

NOTE

- If you choose the simple login to access the LG SmartThinQ application, you must go through the appliance registration process each time you change your smartphone or reinstall the application.

Tag On Function

- For appliances with the  logo
- The Tag On function can only be used with most smart phones equipped with the NFC (Near Field Communication) function and based on the Android OS (operating system).

Download Cycle

Download one of many new special cycles that are not included in the basic cycles on the appliance.

Appliances that have been successfully registered can download one of many specialty cycles specific to the appliance.

Only one Downloaded cycle can be stored on the appliance at the same time.

Once cycle download is completed in the appliance, the appliance keeps the downloaded cycle until a new cycle is downloaded.

Machine Clean Reminder

This function shows how many cycles remain before it is time to run the Machine Clean cycle.

Smart Diagnosis™

This function provides useful information for diagnosing and solving issues with the appliance based on the pattern of use.

Settings

Set the Rinse Aid Dispenser Level, Softening Level, Machine Clean Reminder, Chime Sound and Clean Indicator Light.

NOTE

- Press  in the LG Smart ThinQ application for a more detailed guide on how to use the Tag On function.
- The location of the smartphone's NFC module may vary depending on the phone, and NFC use may be restricted on some smartphones due to differences in transmission methods. Because of the characteristics of NFC, if the transmission distance is too far, or if there is a metal sticker or a protective case on the phone, transmission will not be good. In some cases, NFC-equipped phones may be unable to transmit successfully.
- The content found in this manual may differ from the current version of the LG Smart ThinQ application, and the software may be modified without informing customers.
- NFC function would vary depending on smart phones.

Using Smart Diagnosis™

Smart Diagnosis™ Through the Customer Information Centre

Use this function if you need an accurate diagnosis by an LG Electronics customer information centre when the appliance malfunctions or fails. Use this function only to contact the service representative, not during normal operation.

- 1 Press the **Power** button to turn the appliance on. Do not press any other buttons.
- 2 When instructed to do so by the call centre, place the mouthpiece of your phone close to the Smart Diagnosis™ icon.

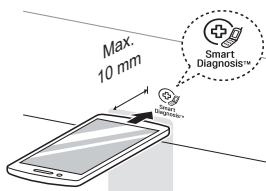



- 3 Press and hold **Download Cycle** until a countdown displays on the appliance.
- 4 Keep the phone in place until the tone transmission has finished.
 - For best results, do not move the phone while the tones are being transmitted.
 - If the call centre agent is not able to get an accurate recording of the data, you may be asked to try again.

- 5 Once the countdown is over and the tones have stopped, resume your conversation with the call centre agent, who will then be able to assist you using the information transmitted for analysis.

NOTE

- The Smart Diagnosis™ function depends on the local call quality.
- The communication performance will improve and you can receive better service if you use the home phone.
- If the Smart Diagnosis™ data transfer is poor due to poor call quality, you may not receive the best Smart Diagnosis™ service.

Smart Diagnosis™ Using a Smart Phone

- For appliances with the  or  logo

Use this function if you need an accurate diagnosis by an LG Electronics customer information centre when the appliance malfunctions or fails.

Smart Diagnosis™ can not be activated unless the appliance is connected to power. If the appliance is unable to turn on, then troubleshooting must be done without using Smart Diagnosis™.

To maintain performance and prevent problems, check the outside and inside of the appliance, including filters and spray arms regularly.

WARNING

- When cleaning the outside and inside of the appliance, do not use any solvent based solutions such as thinners or acetone. It may cause fire or explosion.

NOTE

- If you have not used the appliance for a long time, refresh the inside by running Turbo or Machine Clean programme with detergent. When the cycle is finished, clean the inside and outside of the appliance according to the Maintenance instructions.
- Prevent animals from nibbling on the power cable or water hose.

Cleaning the Exterior

In most cases, the exterior of the appliance can be cleaned with a soft damp cloth or sponge, then dried with a soft cloth. If the appliance has a stainless steel exterior, use a stainless steel cleaner.

Cleaning the Interior

Clean the interior of the appliance periodically with a soft, damp cloth or sponge to remove food and dirt particles.

Food residue may be stuck in the narrow gaps inside the appliance after completion of washing. Wipe off all food residue.

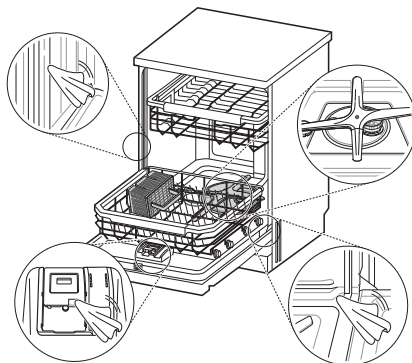

Using Citric Acid

Remove all dishes, cutlery basket and cutlery basket holder from appliance. Only racks should remain in tub. For best results, use citric acid powder (can be found in canning sections of most supermarkets or online). Measure 3 tablespoons (45 g) of citric acid powder. Fill main wash compartment with measured powder.

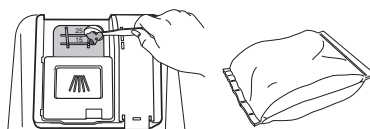

Using White Vinegar

If you cannot find citric acid powder, pour approximately $\frac{3}{4}$ - 1 $\frac{1}{4}$ cups (200-300 mL) of white vinegar into shallow bowl and place in upper rack. Run Auto cycle. Do not use detergent. When the cycle is finished, restart.

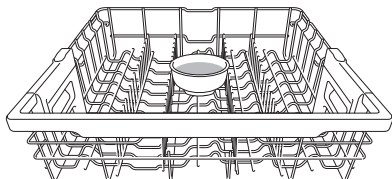

⚠ CAUTION

- Do not pour Vinegar directly into the base.
- Excessive use of vinegar may cause damage to the appliance.

Seasonal Maintenance and Storage

- If you will be absent for an extended period of time during warmer months, close the water valve and unplug the power cord, or turn off the circuit breaker. Clean the filter, tub and dispenser to prevent odor.
- If you will be absent for an extended period of time during colder months and there is a possibility of freezing temperatures, winterize the water supply lines and the appliance itself. Winterization must be performed by qualified service personnel.

Cleaning the Filters

- 1 Remove the lower rack and position the bottom spray arm so a wider vee is open to the front.
- 2 Turn the inner filter counter-clockwise and take out the assembled inner filter and stainless steel filter.

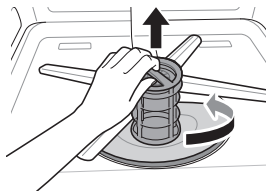

- 3 Clean the filters with a soft brush under running water. Reassemble the filters before reinstalling them.

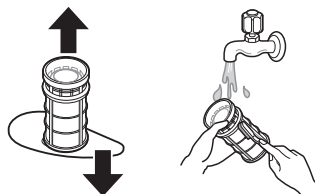

- 4 To replace the assembled filters, position the spray arm so the wider vee is toward the front. Fit the filters back into the filter holder and secure them by turning the inner filter clockwise until it clicks into place.

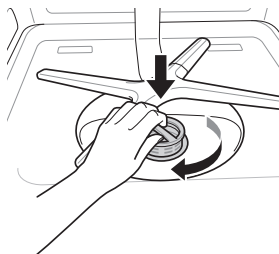

⚠ WARNING

- Be cautious of sharp edges when handling the stainless steel filter.

⚠ CAUTION

- After using the appliance, particles of food are filtered by the filters. Any unremoved food residue may cause bad smell. In addition, drainage may have a problem due to food residue stuck in the filters.

NOTE

- When assembling, rotate it firmly until it clicks.

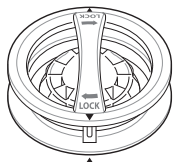

Cleaning the Spray Arms

If the spray arm holes are blocked by any food residue, dishes may not be cleaned well due to improper water spray.

It is recommended that the spray arms be cleaned once every two weeks.

Cleaning the Lower Spray Arm

- 1** Make sure that the water jet holes are not blocked by food particles.
- 2** If any food residue blocks the spray arm holes, remove it with a pin or any sharp tool.

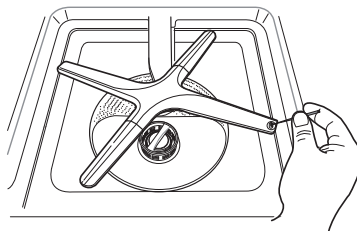

⚠ CAUTION

- To avoid breaking the variable angle spray arm end sections, do not pull or manually rotate them.

Cleaning the Upper Spray Arm

- 1 Pull the upper rack forward. Make sure that the water jet holes are not blocked by food particles.
- 2 When cleaning is necessary, remove the upper spray arm by turning the nut on the bottom of the spray arm $\frac{1}{8}$ turn counterclockwise and pulling down.

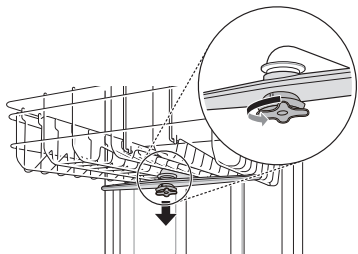

- 3 Remove food particles by rinsing or shaking the spray arm.
- 4 If any food residue blocks the spray arm holes, remove it with a pin or any sharp tool.

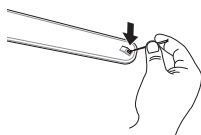

- 5 After removing the food residue, clean the spray arm holes under running water.

- 6 After cleaning the upper spray arm, press it up into place. Turn the nut $\frac{1}{8}$ turn clockwise to make sure that the nut locks back into place.

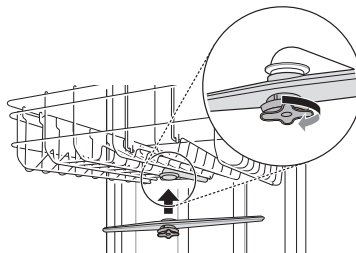

- 7 After assembly, check whether the spray arms rotate freely.

Cleaning the Water Supply Hose Filter

- 1 Unplug the appliance.
- 2 Turn off the water tap.
- 3 Unscrew the water supply hose.
- 4 Remove the seal and the plastic filter with a pair of small pliers or scissor grips.

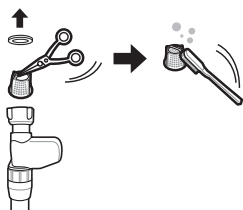

- 5 Refit the filter and gasket and make sure that it is sitting correctly.
- 6 Refit and secure the water supply hose in reverse order. Do not use any mechanical device to tighten the hose. A soft cloth can be used to assist hand tightening.

NOTE

- A filter is fitted into the inlet of the water supply hose connection.
- If insufficient water flows into the appliance, check that the filter is not blocked.
- If there is a leak, the water supply hose will need to be checked for proper connection.
- Never over tighten the water supply valve or use mechanical devices to tighten.
- When reassembling the seal and the filter, ensure that they free from dirt or grit that may have come from the water supply.

The appliance is equipped with an automatic error-monitoring system to detect and diagnose problems at an early stage. If the appliance does not function properly or does not function at all, check the following before you call for service:

Diagnosing Problems







| Problem | Possible Cause | Solutions |
|--|---|---|
| Appliance will not operate. | Door is not completely closed. | <ul style="list-style-type: none"> • Level the appliance again. |
| | Power supply or power cord is not connected. | <ul style="list-style-type: none"> • Connect the power supply or cord properly. |
| | Control Lock is activated. | <ul style="list-style-type: none"> • Cancel of the Control Lock button. |
| | Fuse is blown or circuit breaker tripped. | <ul style="list-style-type: none"> • Replace the fuse or reset the circuit breaker. |
| Appliance continuously beeps when the door is opened, during or right after a cycle has completed. | The contents of the appliance are hot and care should be used when placing your hands inside the appliance. | <ul style="list-style-type: none"> • Close the door until the appliance and dishes have cooled down. The beeping will stop if the door is closed or the interior temperature has cooled. |
| Water remains in sump after completion of cycle. | Drain hose is kinked or clogged. | <ul style="list-style-type: none"> • Adjust hose or clear blockage. |
| | Water may remain if the power supply was lost before normal end of the course or was manually disconnected. | <ul style="list-style-type: none"> • Re-start the course. |
| Sprays arms do not rotate smoothly. | Holes of spray arms are blocked by food particles. | <ul style="list-style-type: none"> • Clean the holes of spray arms. |
| Upper rack is crooked. | Rack is poorly adjusted. | <ul style="list-style-type: none"> • See the Height Adjustable Upper Rack section. |
| Lamps do not illuminate. | Power is not connected. | <ul style="list-style-type: none"> • Connect power supply. |
| There is excessive foam inside the appliance. | Failure to use the detergent exclusive for appliance. | <ul style="list-style-type: none"> • Use the detergent exclusive for appliance. |
| | An excessive amount of rinse may cause foam. | <ul style="list-style-type: none"> • Reduce the rinse aid dispensing level. |

| Problem | Possible Cause | Solutions |
|---|--|---|
| Detergent is left in the detergent dispenser. | Unbalanced upper rack. | <ul style="list-style-type: none"> Adjust the left/right height of the upper rack. |
| | Detergent may not be dispensed because poor stacking of the dishes prevent automatic opening of the detergent dispenser. | <ul style="list-style-type: none"> Correctly arrange the dishes and always dry out the dispenser before adding new detergent so that it does not clump together. |
| Water leaks outside the appliance. | The door may not be closed due to tilted appliance. In this case a water leak may occur. | <ul style="list-style-type: none"> Check the leveling by adjust the leg. |
| | Wrong installation of drainage hose may cause water leak. | <ul style="list-style-type: none"> Check the connecting part of drainage hose. |
| | If the power is off, a water leak may be caused by a poor connection to the tap. | <ul style="list-style-type: none"> Check the connection water supply hose. |
| Cloudiness on glassware. | Combination of excessive detergent and hard water. | <ul style="list-style-type: none"> Use less detergent and use a rinse aid to minimize the problem. Check the setting of softening system. |
| Black or gray marks on dishes. | Aluminum items rubbing dishes during cycle. | <ul style="list-style-type: none"> Reposition the dishes. |
| Yellow or brown film on inside surfaces of appliance. | Coffee or tea stains. | <ul style="list-style-type: none"> Eliminate the stain by using a stain removal product. |
| Yellow water remains inside the dishwasher | When initially using the appliance, Yellow water may generate in the water softener tank. | <ul style="list-style-type: none"> This is a normal condition, and it is harmless to humans. It disappears after 1~3 cycles. |
| Dishes don't dry. | Rinse agent dispenser empty. | <ul style="list-style-type: none"> Check and refill the rinse agent dispenser if empty. For better drying results, slightly open the door after operation. |

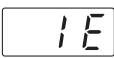
| Problem | Possible Cause | Solutions |
|--------------------------------------|---|---|
| Spots and filming on dishes. | Wrong amount of detergent used. | <ul style="list-style-type: none"> • Use the recommended amount of detergent. |
| | Overloading. | <ul style="list-style-type: none"> • Do not overload the appliance. |
| | Improper loading. | <ul style="list-style-type: none"> • See the Operation section. |
| | Insufficient water pressure. | <ul style="list-style-type: none"> • Water pressure should be between 20 and 80 psi. |
| | Insufficient detergent. | <ul style="list-style-type: none"> • Add the recommended amount of detergent. See the Operation section. |
| | Rinse aid dispenser is empty. | <ul style="list-style-type: none"> • Refill rinse aid dispenser. |
| | The water softener has no salt or insufficient the salt. | <ul style="list-style-type: none"> • Check whether there is the salt in the water softener. |
| | Water hardness level may be set too low. | <ul style="list-style-type: none"> • Increase the hardness level setting value. |
| | The rinse aid may be insufficient. | <ul style="list-style-type: none"> • Refill the rinse aid or increase the dispensing level. |
| Hard water buildup in the tub | <ul style="list-style-type: none"> • Remove all dishes, cutlery basket and cutlery basket holder from appliance. Only racks should remain in tub. For best results, use citric acid powder (can be found in canning sections of most grocery stores or online). Measure 3 tablespoons (45 g) of citric acid powder. Fill main wash compartment with measured powder. If you cannot find citric acid powder, pour approximately $\frac{3}{4}$ - 1 $\frac{1}{4}$ cups (200-300mL) of white vinegar into shallow bowl and place in upper rack. Run Auto cycle. Do not use detergent. When the cycle finish, run it again. | |

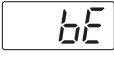
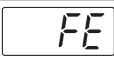
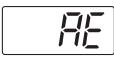
| Problem | Possible Cause | Solutions |
|------------------------------|---|---|
| Odor | The previous cycle was stopped before completion and residual water remains in the appliance. | <ul style="list-style-type: none"> • Turn on the power, run the Cancel cycle option to remove the residual water, then run the Quick cycle using detergent but with the appliance empty. |
| | There is food in the bottom of the unit or in the filter. | <ul style="list-style-type: none"> • Clean the filter and the interior according to the Maintenance section of the owner's manual. |
| | Unwashed dishes are left in the unit for a long time. | <ul style="list-style-type: none"> • Cycle with one cup of white vinegar in a appliance safe glass or bowl placed on the upper rack. (Vinegar is an acid, and with constant use it could damage your appliance.) |
| Food soil remains on dishes. | Improper cycle selection. | <ul style="list-style-type: none"> • Select correct cycle based on soil level and type of dishware being washed. |
| | Water temperature is too low. | <ul style="list-style-type: none"> • Check water supply connection or water heater setting. |
| | Dishwashing detergent was not used. | <ul style="list-style-type: none"> • Use recommended detergent. |
| | Low inlet water pressure. | <ul style="list-style-type: none"> • Water pressure should be between 20 and 80 psi. |
| | Water jet holes on spray arms blocked. | <ul style="list-style-type: none"> • Clean the spray arms. |
| | Improper loading of dishes. | <ul style="list-style-type: none"> • Make sure dishes do not block spray arm rotation or interfere with detergent dispenser. |
| | Filters are clogged. | <ul style="list-style-type: none"> • Clean filters. |
| Noise | Some level of noise is normal during operation. | <ul style="list-style-type: none"> • Detergent cover opening. • Drain pump at the beginning of drain cycle. |
| | The appliance is not level. | <ul style="list-style-type: none"> • Adjust leveling feet. |
| | Nozzle arm knocking against dishes. | <ul style="list-style-type: none"> • Reposition the dishes. |
| | Water pressure is too high. | <ul style="list-style-type: none"> • Adjust water pressure. |

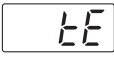
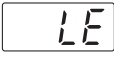
Error Codes

| Problem | Possible Cause | Solutions |
|---|--|---|
|  | Water inlet problem. | <ul style="list-style-type: none"> • Check for a clogged, kinked or frozen water supply hose. • Check water supply. |
|  | Drainage Problem. | <ul style="list-style-type: none"> • Check for a clogged, kinked or frozen drain hose. |
| | Waste spigot is clogged. | <ul style="list-style-type: none"> • Remove knockout on waste spigot. |
| | Filters are clogged. | <ul style="list-style-type: none"> • Clean Filters. |
|  | Oversudsing caused by improper detergent, such as liquid dish soap. | <ul style="list-style-type: none"> • Do not use hand dishwashing liquids. Only use detergents which are designed for use in automatic dishwashers. • To remove detergent residue in the tub, pour approximately 100~200 ml of milk into a shallow bowl, place it to the upper rack and then run the appliance on the Auto cycle. |
| | Failure to level appliance. | <ul style="list-style-type: none"> • Make sure that the appliance is properly leveled. |
|  | Excessive Water supplied. | <ul style="list-style-type: none"> • Call for service if the same problem occurs again. |
|  | Water leakage problem. | |
|  | Heater circuit failure. | |
|  | Thermistor failure | |
|  | Motor trouble | |
|  | Vario motor trouble | |

Memo

