

VOLTA

MobiMAXX
Instruction Manual

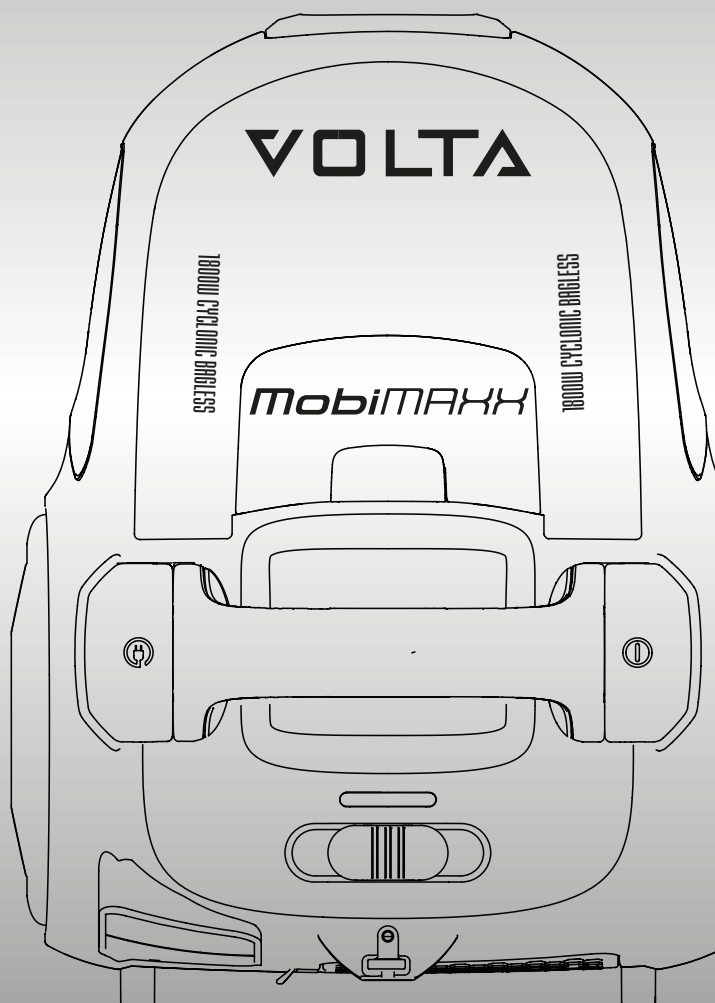

U3510

IMPORTANT SAFETY INSTRUCTIONS

READ ALL INSTRUCTIONS BEFORE USING (THIS APPLIANCE)

When using an electrical appliance basic precautions should always be followed, including the following. Before connecting the cleaner to an electrical supply outlet, ensure that the voltage marked on the rating plate (on the underside of the cleaner) is correct for your electrical supply. If it does not comply, do not use the cleaner prior to contacting the manufacturer.

WARNING – To reduce the risk of fire, electric shock, or injury:

1. Do not leave vacuum cleaner when plugged in. Unplug from outlet when not in use and before servicing.
2. To reduce the risk of electric shock, do not use outdoors or on wet surfaces.
3. This appliance is not intended for use by persons (including children) with reduced physical, sensory or mental capabilities, or lack of experience and knowledge, unless they have been given supervision or instruction concerning use of the appliance by a person responsible for their safety. Children should be supervised to ensure that they do not play with the appliance.
4. Use only as described in this manual. Use only manufactures recommended attachments.
5. Do not use with damaged cord or plug. If vacuum cleaner is not working as it should, has been dropped, damaged, left outdoors, or dropped in water, take it to a service centre before using.
6. Do not pull or carry on cord or use as a handle. Do not close door on cord, or pull around sharp edges or corners. Do not run vacuum cleaner over cord. Keep cord away from heated surfaces.
7. Do not unplug by pulling on the cord. To unplug, grasp the plug, not the cord.
8. Do not handle the plug or vacuum cleaner with wet hands.
9. Keep hair, loose clothing, fingers and all parts of body away from openings and moving parts.
10. Turn all controls off before unplugging.
11. Do not use to pick up flammable or combustible liquids, such as gasoline, or use in areas where they may be present.
12. Do not pick up anything that is burning or smoking, such as cigarettes, matches, or hot ashes.
13. Do not use without dust container and/or filter in place.
14. Do not use extension cords or outlets with inadequate current carrying capacity.
15. We recommend you do not use your vacuum on carpet cleaning foams, sharp or heavy building materials or plaster dust. They could damage or clog the filters and cause failures to other key parts in your vacuum cleaner and render your warranty invalid.
16. Store your cleaner indoors in a cool, dry area.
17. Unplug electrical appliances before vacuuming them.
18. Please remove the plug from the socket outlet before cleaning or maintaining this appliance.

ELECTRICAL CABLE PRECAUTIONS

- If the supply cord is damaged, it must be replaced by the manufacturer, its service agent or similarly qualified person in order to avoid a hazard. Damage to the cleaner cable will not be covered by the warranty.
- Never pull or lift the vacuum cleaner by the cable.
- Disconnect the plug from the wall socket before cleaning or maintaining the vacuum cleaner.
- Regularly check that the cable is not damaged. Never use the vacuum cleaner if the cable is damaged. All service and repairs must be carried out by an authorised Electrolux service centre. Always keep the vacuum cleaner in a dry place.

SERVICE & REPAIR

It is dangerous to alter the specifications or modify the product in any way. Under no circumstances should you attempt to repair the cleaner yourself.

NEVER VACUUM

- In wet areas.
- Close to flammable gases, combustible substances, etc.
- Without a cartridge filter (this may damage the cleaner) and without the dust container. A safety device is fitted which prevents the cover to close without the filter. Do not attempt to force to close the cover.
- Sharp objects.
- Fluids (this can cause serious damage to the machine).
- Hot or cold cinders, lit cigarette butts, etc.
- Fine dust from plaster, concrete, or ash, for example. The above can cause serious damage to the motor – damage which is not covered by the warranty. Products in aerosol may be flammable. Do not spray these products on or near the vacuum cleaner.

DOUBLE INSULATION

Your vacuum cleaner is double insulated. This means that all external parts are electrically insulated from the mains. This is done by placing insulation barriers between the electrical and mechanical components, making it unnecessary for the cleaner to be earthed.

WARNING: On collection of proprietary carpet conditioning powder, it is recommended that the dust container is emptied and the cartridge filter is cleaned after each use. Some of the preparations contain substances which if left in the vacuum cleaner for extended periods, could cause damage. Many air fresheners, household deodorants, sprays and polishes contain highly inflammable gas propellants, because of this it is particularly important that these products are used strictly in accordance with the relevant manufacturers instructions, it is essential that none of the above products are sprayed directly into the vacuum cleaner or any of the filters, hose assembly or dust chamber.

Product and Accessories

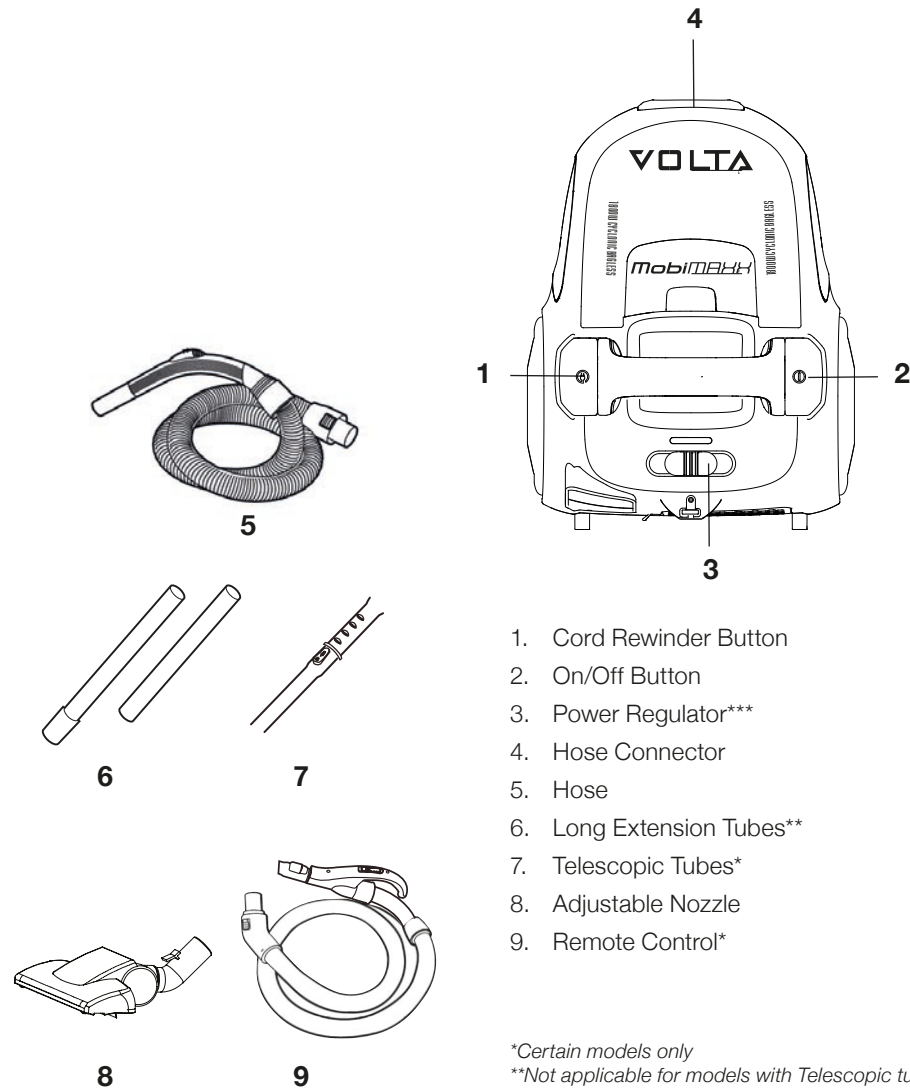

*Certain models only

**Not applicable for models with Telescopic tubes

***Not applicable for models with Remote Control

Quick Guide

BEFORE STARTING

- On first removing the product from its packaging, check for any damage.
- Check that the dust container and the filters are in place. Never operate the cleaner without the dust container installed.
- Always remove the plug from the power supply before fitting or removing any accessories.

ASSEMBLING THE VACUUM CLEANER

Fitting or removing the flexible hose

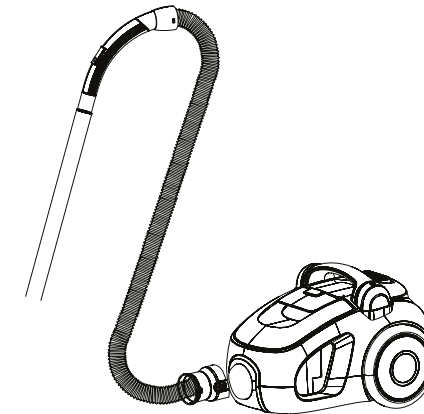

- Insert the hose until the catch clicks to engage (press the catch to release the hose).

Fitting extension tubes and accessories

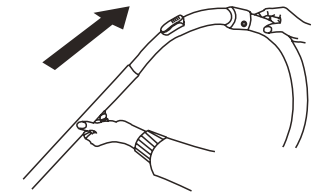

- Attach the extension tubes or telescopic tube (only on certain models) to the hose handle.

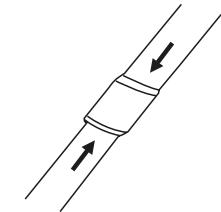

- Fitting the extension tube to the floor brush.

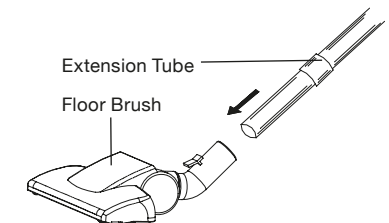

Instructions for Use

SWITCHING ON

Extend the cord and plug it into the wall socket. A yellow mark on the power cable shows the ideal cable length. Don't extend the cable beyond the red mark.

- Press the On/Off button to switch the unit on. To stop, press the button again.

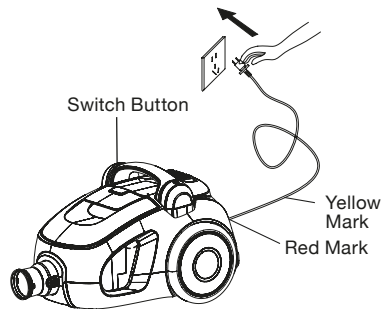

- To retract the cord, switch off the appliance and unplug it from the wall socket. The vacuum cleaner has an integrated cord winder. To rewind the cable press the foot pedal gently and guide the cord by one hand, this will prevent it striking you or damaging the cleaner.

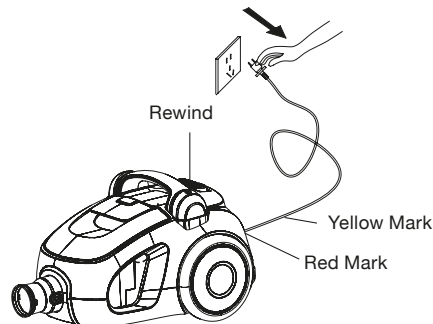

- Slide the electronic power switch to control the suction of the cleaner.

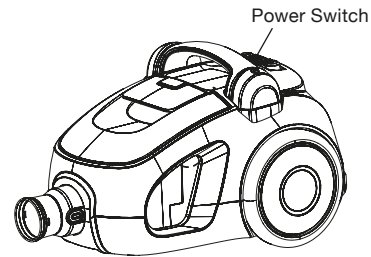

ACCESSORIES

Use the appropriate accessory according to the object(s) to be cleaned:

- **Crevice nozzle**
For corners, between cushions and difficult-to-reach places.

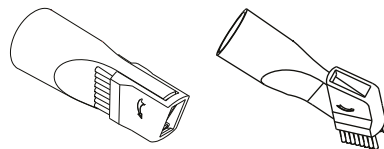

- **Upholstery nozzle**
For upholstered furniture and curtains.

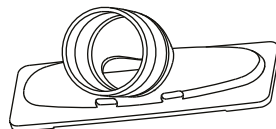

- **Combination floor nozzle**
Can be set for hard floors or carpets.

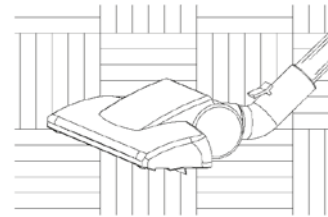

Carpet

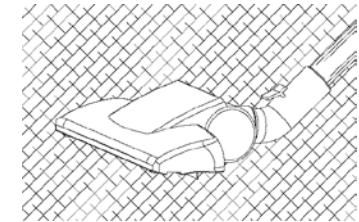

Hard Floor

Maintenance

EMPTYING THE DUST CONTAINER

- Empty the dust container.

Note: Before removing the dust container, switch off the appliance and disconnect the flexible hose.

- Remove the dust cup by pushing the open buttons on the dust container handle. Remove the content of the dust cup by pushing the opening button. The dust container is a detachable unit. Hold the base of the dust cup with one hand and open the dust container by pushing the opening button with the other hand.

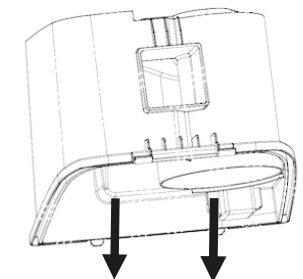
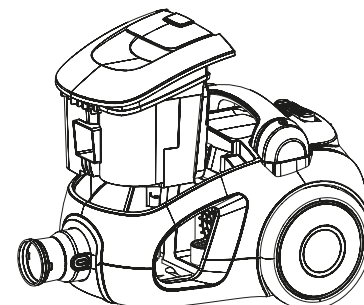
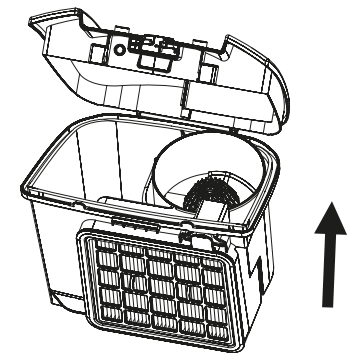

- To close the dust container, ensure the hinge is securely fastened before you lock the cover.

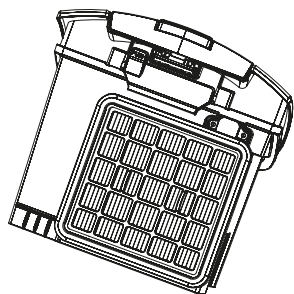

- Replace the dust container into the cleaner.
- Always operate the appliance with the dust container properly installed.

REPLACING AND CLEANING THE HEPA FILTER

- Filter for air-inlet should be cleaned at least twice a year or when it becomes visibly solid.
- Always operate the cleaner with filters to avoid reduced suction or a motor damage.
- Remove the dust container as described in the previous section.
- There are two pre-motor filters in this vacuum cleaner, a spongy grey protection filter, and the framed HEPA filter .
- Remove the filter frame from the container by pulling on the release tab on the top right side of the filter frame. Remove the grey protection filter by simply pulling it loose from the container.

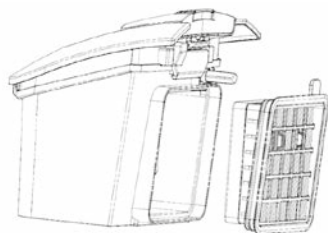

- Tap the filter face down on a flat surface covered with a sheet of paper. This will dislodge excessive residue from the filter. Dispose of the cover sheet with the dust residue. Gently beat the grey protection filter in an open air space to properly dislodge any dust.

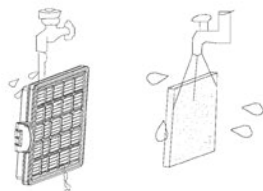

- If necessary both the HEPA filter and grey protection filter can be washed under a tap with cold water. Always wash the filter from the underside, do not scrub or use cleaning agents on the filter. Do not use a washing machine to wash the filter.

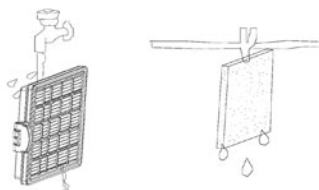

- Air dry both the filters for 24 hours to ensure they are completely dry before reusing. Avoid direct sunlight or extreme drying conditions. Do not use a hair dryer to dry the filters.
- Refit the grey protection filter by aligning it with the dust container and sitting it in place, then fit the filter in the frame by aligning the frame with the dust container and simply sliding it into place.
- When fitted correctly a safety device will allow the dust container to fit back into the dust container only if the filter is properly installed. If the dust container does not fit into the dust compartment do not force it. Check the filter is properly installed.
- If either of the filters appear damaged do not reuse them.

CHANGING THE EXHAUST FILTER

- Open the grill on the rear cover.
- Take the filter out and replace it with a new one.
- Put the filter on the grill.
- Put the grill and filter back.

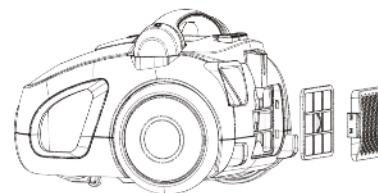

How To Store Your Vacuum

1. Choose a storage location that is both safe and dry.
2. Depending on the space available, you can choose to store it in an upright or horizontal position using the parking slot.
3. Be careful not to trap, twist or tie the electrical cord. Wind it.
4. Keep the extension tubes, nozzles and hose together to avoid misplacing them.

Disposing Your Vacuum

PACKAGING MATERIAL

The packaging materials are environmentally-friendly and can be recycled. The plastic components are identified by markings, e.g. >PE<, >PS<. Please dispose of the packaging materials in the appropriate container at a community waste disposal facility.

OLD APPLIANCE

The symbol  on the appliance or its packaging indicates that this product may not be treated as household waste. Instead, it should be handed over to the applicable collection point for the recycling of electrical and electronic equipment.

By ensuring that this product is disposed of correctly, you can help prevent potential negative consequences for the environment and human health. For more detailed information about recycling, please contact your local city council.

TROUBLE SHOOTING

You can perform your own troubleshooting at home based on the checklist given in this section. However, if the problem persists, please contact Electrolux on **1300 366 366** (AUS) or **0508 730 730** (NZ)

PROBLEM	POSSIBLE CAUSES	CORRECTIONS
Vacuum cleaner does not start.	Plug is not properly connected to the socket.	Check the plug connection or try another socket.
	Thermal protector activated due to high temperature.	Press the On/Off button and wait 20-30 minutes for the motor to cool down.
Filter indicator light stays on.	Dust container is full.	Empty the dust container.
	Filters are clogged.	Clean or replace filters.
Reduction of suction capacity.	Suction hose is blocked.	Clean the hose.
	Nozzle is blocked.	Clean the nozzle.
	Dust container is full.	Empty the dust container.
	Filters are clogged.	Clean or replace filters.
	Hose is damaged or broken.	Change the hose.
Over-heating.	Dust container is full.	Empty the dust container.
	Filters are clogged.	Clean or replace filters.

KEEP THIS FOR YOUR RECORDS

To be completed by the Purchaser

Model

Serial No

Date of Purchas

Retailers Name

Retailers Address

.....

City State

Attach Your Purchase Receipt Here

Electrolux Home Products Pty Ltd

ABN 51 004 762 341

163 O'Riordan Street, Mascot, NSW 2020, Australia

Customer Service - Ph: 1300 366 366

www.electrolux.com

Electrolux Small Appliances

A division of Electrolux (NZ) Limited

3 - 5 Niall Burgess Road, Mt. Wellington, Auckland, New Zealand

Ph: (09) 9573 2220 Customer Service - Ph: 0508 730 730

www.electrolux.com

*Some models may be limited in availability or be available from certain stores only.

Not all models and specifications are available at time of printing and not all models are available in Australia & New Zealand. See your local Electrolux retailer or call the above phone numbers for further information if required.

*Due to the Electrolux policy of continual product development; specifications, colours and details of our products and those mentioned in this manual are subject to change without notice.