

Description: **ROBINHOOD WALL CANOPY**
Model Numbers: **RWC3CH6SS, RWC3CH9SS, RWC3CH6WH, RWC3CH9WH**

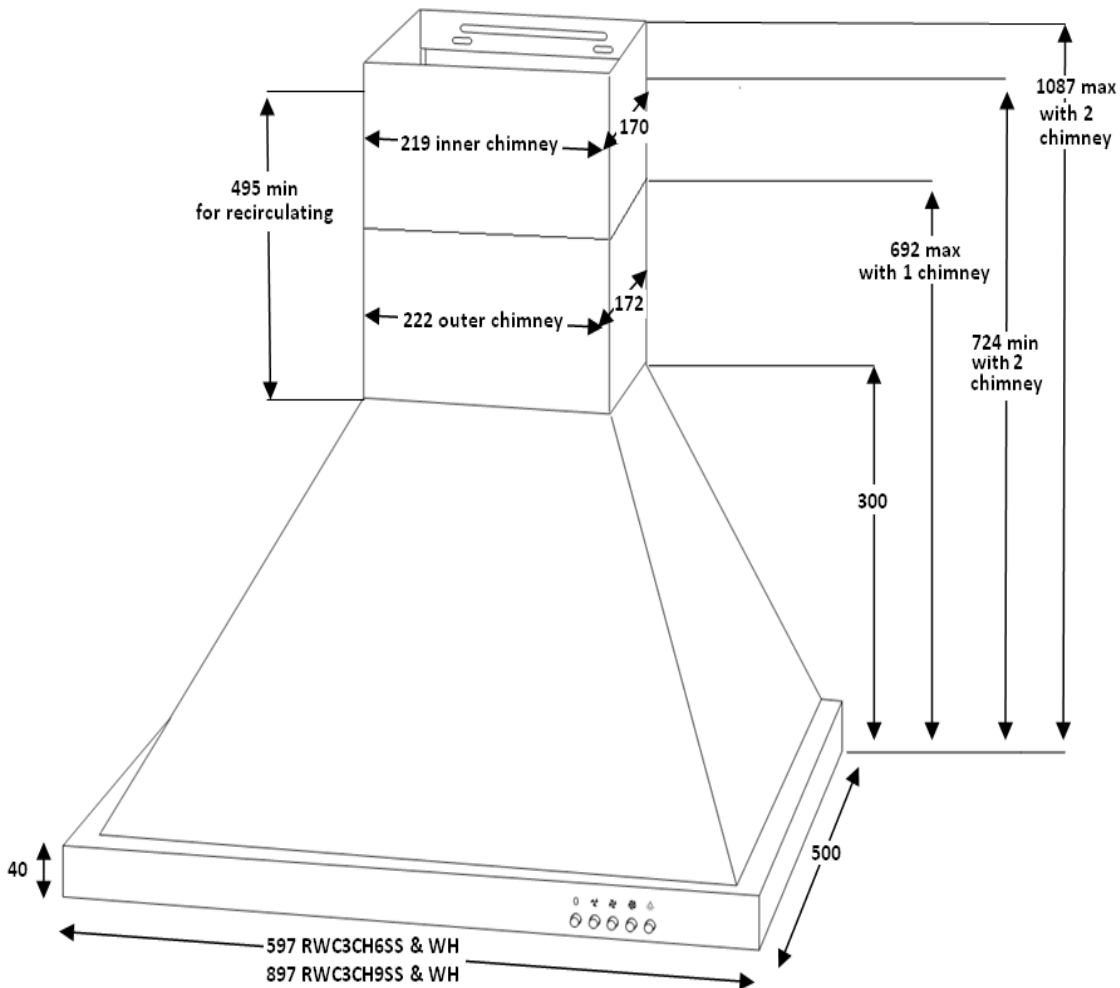

All dimensions + or - 2mm











Model pictured: **RWC3CH6SS/WH**

All dimensions in mm
Model may vary slightly from images pictured

Pre-installation

Thank you for purchasing a quality Robinhood rangehood. Robinhood has a high standard of quality control and every rangehood is tested and approved before it leaves the factory.

Important:

-  Please read the entire instructions before installing the rangehood.
-  Always switch power off prior to installation.
-  All electrical work must be done in accordance with local and national electrical codes as applicable.
-  For safety, this product must be earthed.
-  A power outlet should be within 1000mm of the power cord exit from the rangehood.
-  The socket must be accessible and enable the end user to isolate the rangehood from the power for the purpose of internal cleaning or maintenance.
-  Stainless steel or powder coat is very easily damaged during installation if abraded or knocked by tools. Protect the rangehood with the cardboard box or plastic bag during installation.
-  All ducting must comply with local requirements and building codes.
-  Suitable fixings will be required to mount this rangehood.
-  See Ducting options next page.

-  Note that Accessible parts may become hot when used with cooking appliances.

Contents of packaging:

- 1 x rangehood
- 1 x 150mm ducting adaptor
- 1 x packet of fasteners and wall plugs
- 2 x chimney pieces (upper and lower)
- 2 x chimney bracket
- 1 x fixing plate

Typical equipment required:

- electric drill
- screwdriver
- tape measure
- spirit level
- duct tape (*if ducting*)
- jig saw and ladder(*if ducting*)

Ducting Options

The method of ducting should be carefully considered before installing the rangehood. The guide below recommends the ducting components to use for all common ducting configurations - through the top of the home (for the roof and soffit) and through the rear of the home. 150mm round ducting should be used in conjunction with this model rangehood. Alternatively this rangehood can be operated in recirculation mode (see Recirculation mode pg 6).

The highlighted area in the table below gives the recommended Uniduct item numbers for different mounting and outlet options.

Duct mounting option			
	Rear	Top (roof)	Top (soffit/eave)
			
Uniduct item numbers			
150mm diameter round outlet	1688	1634 and 1635	1634 and 1688

Figure 2.

Extra lengths and/or bends may be required, depending on the length required and whether there is any structural material in the run e.g. rafters.

Please note that this chart is designed as a guide. Please consult Robinhood customer services if unsure. For NZ phone 0800 760 667 or www.robinhood.co.nz. For AUS phone 1800 648 556 or www.robinhood.com.au.

Installation position

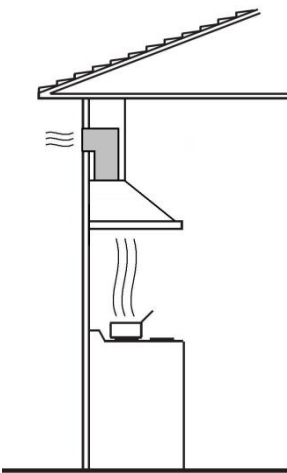
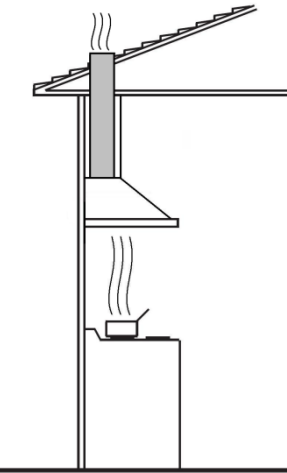
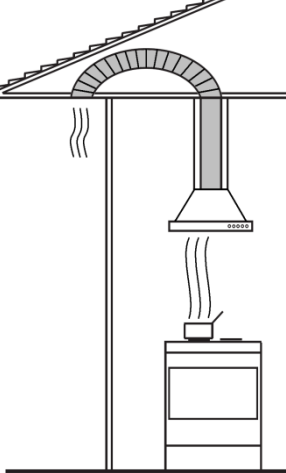
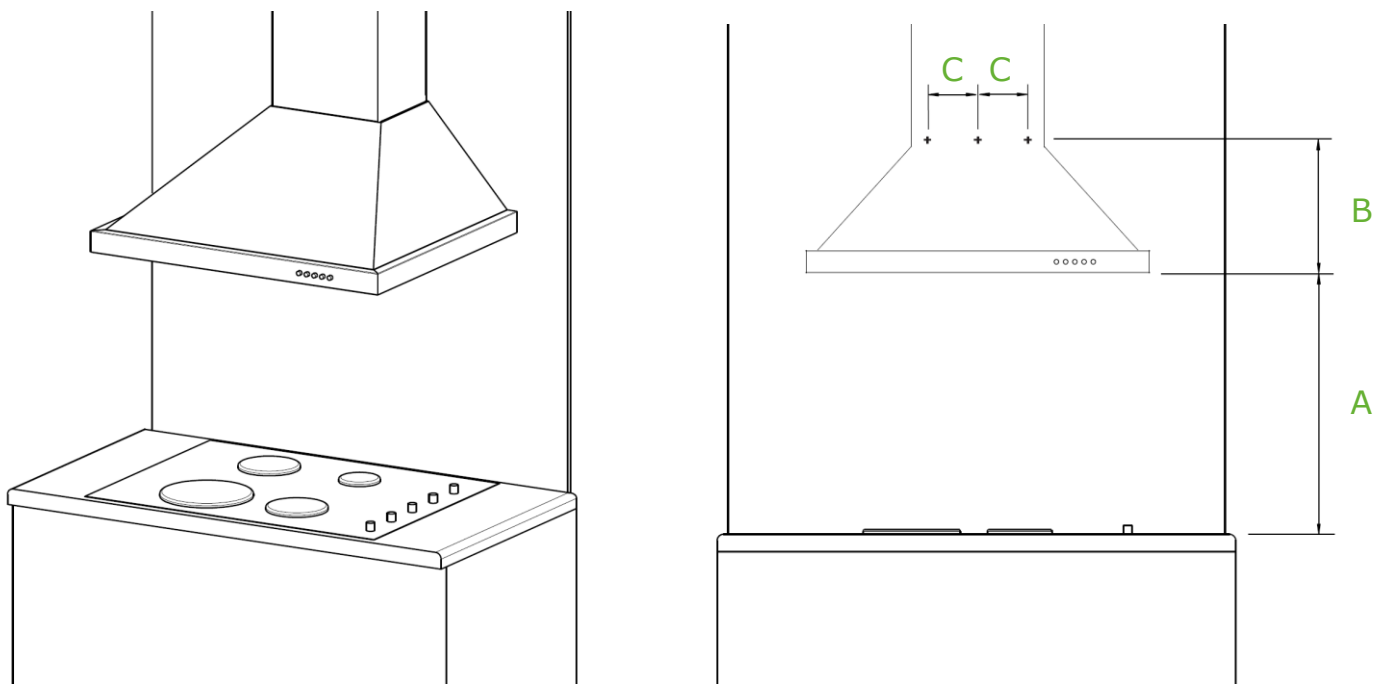

- A Minimum** height from the hob surface to the underside face of the rangehood
600mm electric hob
650mm gas hob

Notes: If the instructions for the gas hob specify a greater distance, this has to be taken into account. Any installation above 750mm will compromise performance.

- B** Vertical height from bottom of Rangehood to Fixing Plate mounting screws
323mm.
- C** Distance between mounting screw holes on Fixing Plate
100mm.

Installation

Mounting to a stud is recommended. However, if fitted to other wall linings (plasterboard, concrete etc) suitable fixings will be required. Before drilling any holes check that the wall and ceiling are clear of any electrical cables, pipes etc.

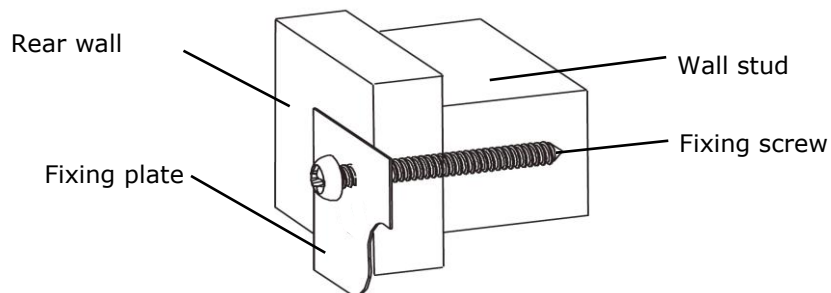

1. Pre drill pilot holes in the positions given (pg 4 - Installation position). Fix the fixing plate using the screws supplied or appropriate wall fixings, check with a spirit level to ensure bracket is level. Tighten screws.

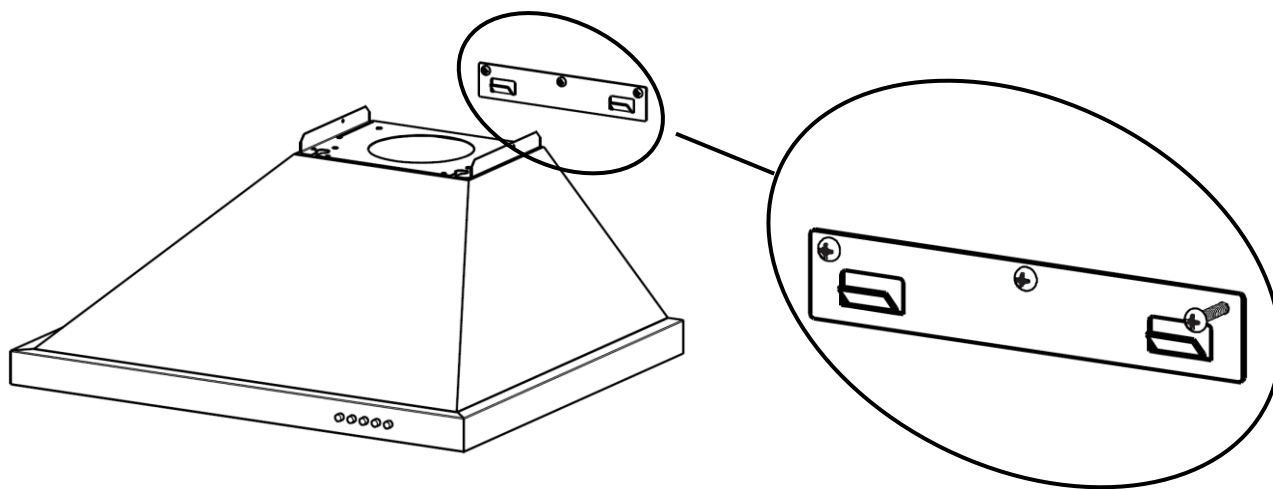

2. Mark the position of the decorative chimney at the ceiling and wall. Cut the cornice moulding away if required, to enable the chimney to sit flush against the wall and ceiling.
3. **Only if ducting** - Mark and cut out the hole in the ceiling / wall to fit the ducting (160mm dia max). Warning: Chimney depth is 172mm. Ensure no part of the hole is greater than 170mm from the wall.
4. Use the upper chimney bracket as a template to mark the fixing screw positions. Using the screws supplied, fix the chimney bracket to the wall, checking that it is central about the canopy.

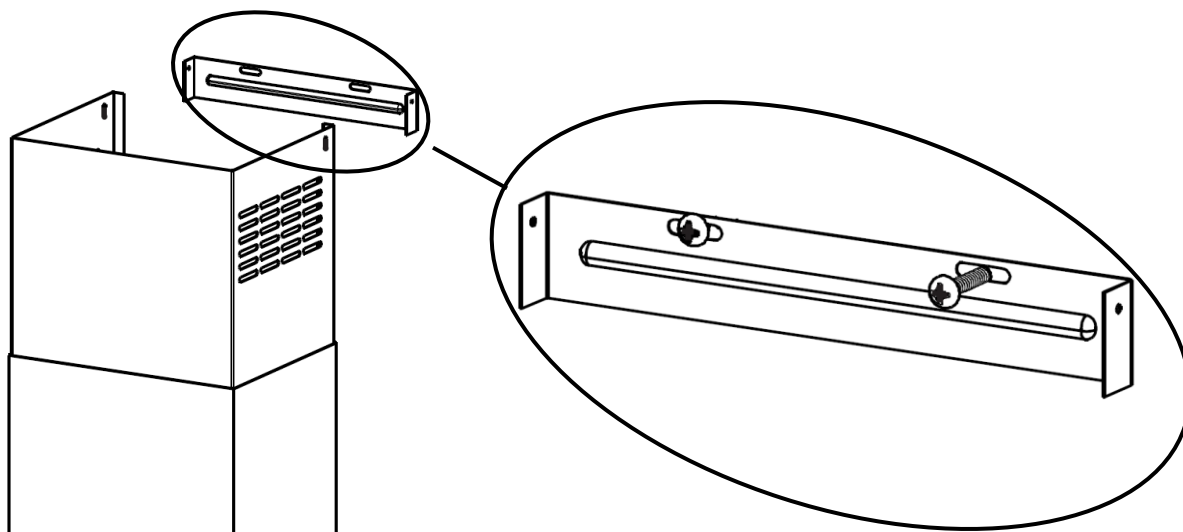

Installation - *continued*

5. Connect and secure the ducting (use duct tape if required).
6. Remove the protective plastic covering from all parts including the filters. Fit the canopy hood on the fixing bracket. Mark and drill the two holes required for the safety screws. Secure the canopy in place with the safety screws provided. The safety screws stop the canopy from accidentally being knocked off the fixing plate.
7. Insert the upper chimney piece into the lower chimney piece. Assemble the lower chimney bracket onto the lower chimney using screws provided and ensure the bracket holds both chimney pieces. Do not fully tighten the screws as some adjustment is required in step 9.

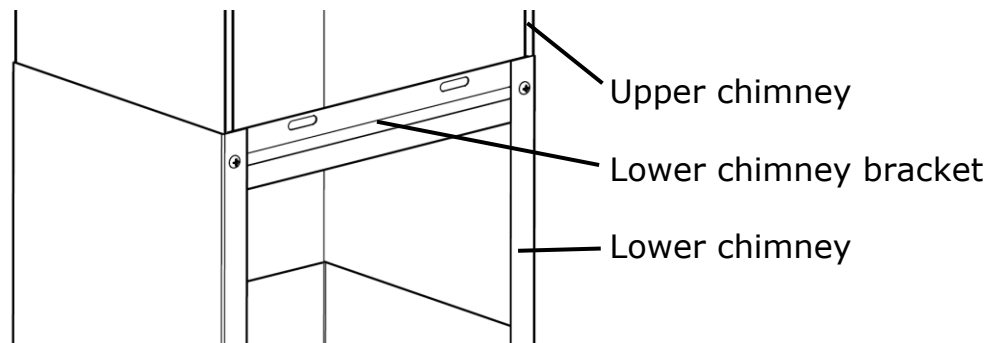

8. Connect to the power supply and switch on the power to the canopy hood. Check the function of the canopy hood. Connect and secure the ducting (use duct tape if required).
9. Place the two chimney pieces onto the canopy top and secure the lower part to the canopy sides. Extend the upper chimney to the ceiling and secure in place with two screws supplied.

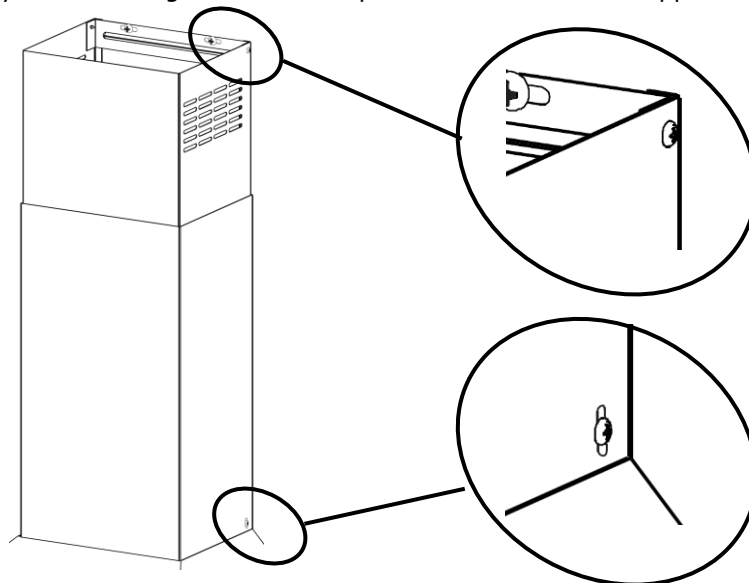

Recirculation mode

1. This unit can be installed to operate in recirculation mode where ducting is not a chosen/desired or practical option. There are recirculation grilles fitted on each side of the upper chimney which allow the cleansed air to return to the kitchen. Ensure that the side outlet grilles are not obstructed. Even a partial obstruction will restrict the efficiency of the rangehood.
2. Replace aluminium filters with charcoal filters (see pg 7 for part numbers).

Operating instructions

Controls

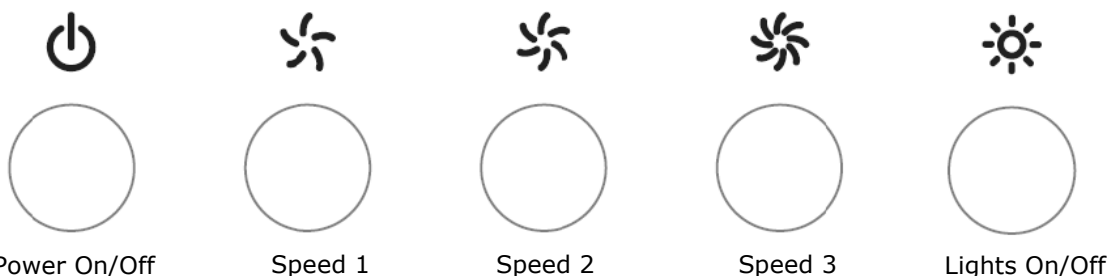

Light

The light can be operated independently from the fan and is controlled in accordance with the graphics printed above.

Fan

The fan is operated by turning the power switch on. It can be run at three different speeds (Speed 1 / Speed 2 / Speed 3) depending on the cooking requirements and is controlled in accordance with the graphics printed above.

Cleaning and maintenance

General Maintenance

Switch off the rangehood before cleaning or maintenance.

 To prevent surface damage never use abrasive or oil based liquid cleaners. To clean the surfaces of the appliance, use mild detergent and warm water. In areas of high humidity and coastal environments cleaning should be carried out frequently.

 Warning: a build up of oil may occur if the compact canopy is not cleaned regularly.

Filter Maintenance

To maintain efficiency, the filters should be removed regularly (approximately monthly), and washed using hot soapy water or the dishwasher.

 Some discolouration of the filter frame may occur if washed in the dishwasher.

Rangehoods fitted with charcoal filters are designed to remove grease and odours from cooking vapours prior to the cleansed air re-entering the kitchen (when the rangehood is in recirculation mode). Charcoal filters should be replaced every two to four months depending on use.

 Fully saturated charcoal filters can become a barrier to air movement therefore limiting rangehood performance. In the event of fire, grease laden filters could be flammable and therefore regular replacement is recommended. In ducted installations, conventional aluminium filters are recommended.

Replacement of Halogen Lamps

 **To replace a lamp, first disconnect the rangehood from the power supply and ensure the lamp has had time to cool down before touching.**

Use a small blade screwdriver to prise off the lamp cover taking care to avoid the lamp lens falling on to the hob top. The halogen bulb is a push fit into the lamp body, replace the lamp by inserting the replacement lamp into the lamp holder and replace the lens and lamp cover.

Replacement parts













- Charcoal filter 2536 (2 pack - 600 Model)
2537 (3 pack - 900 Model)
- Light bulb 12V 20W 104467
- Chimney extensions 10 ft: 2188 Stainless Steel, 2180 White
12 ft: 2189 Stainless Steel, 2181 White

For any other problems please call help line on NZ 0800 760 667 or AUS 1800 648 556

Product approvals and ratings

Product approval number	VO71158, A/11730EA, SAA103676EA
Product rating	230W (1.15A) Max at 240V 50Hz
Electric approval AS/NZS	60335.2.31:2004
EMC AS/NZS	CISPR14:2001
Performance tested	IEC61591

Important safety information

-  All electrical work must be done by a registered electrician in accordance with local and national electrical codes as applicable. For your safety, this product must be earthed.
-  If the supply cord of this equipment is damaged, it must only be replaced by the manufacturer or its service agent or a similarly qualified person in order to avoid a hazard.
-  This rangehood is designed for indoor use only and must be in a dry location.
-  Disconnect the power supply when changing light bulbs.
-  This appliance is not intended for use by persons (including children) with reduced physical, sensory or mental capabilities, or lack of experience and knowledge, unless they have been given supervision or instruction concerning use of the appliance by a person responsible for their safety.
-  Young children should be supervised to ensure that they do not play with the appliance.
-  There shall be adequate ventilation of the room when the rangehood is used at the same time as appliances burning gas or other fuels.
-  There is a fire risk if cleaning is not carried out in accordance with the instructions. You must read the details concerning the method and frequency of cleaning.
-  Do not flambé under the rangehood.
-  Exhaust air must not be discharged into an existing flue which is used for exhausting fumes from appliances burning gas or other fuels.
-  The minimum distance between the hob surface and the lowest part of the rangehood is 600mm. This distance shall be at least 650mm, if the rangehood is installed over a gas hob. If the instructions for the gas hob specify a greater distance, this has to be taken into account.
-  Attention should be given to ensure that any applicable regulations concerning the discharge of exhaust air is fulfilled.
-  Note that Accessible parts may become hot when used with cooking appliances

Notes:

- Please remember to fill out the details on the warranty certificate (do not post).
- Remove any plastic coating from the product.
- Ensure safety screws are fitted.

Warranty Certificate (New Zealand)

Terms and Conditions

The following conditions apply in respect of the warranty given in this certificate:

1. Parbury Pty Limited ("Parbury") warrants the following Robinhood products against manufacturing defects and faulty materials, under normal use and subject to the exclusions in this certificate, for a period of:
Rangehood - 24 months from date of original purchase for domestic use.
Uniduct - 12 months from date of original purchase for domestic use.
Ironing centre - 12 months from date of original purchase for domestic use.
Waste disposal - 24 months from date of original purchase for domestic use.
"Original purchase", when used in this certificate, means purchase by the customer directly from Parbury or one of its approved suppliers.
2. This warranty is limited to the repair or replacement, at our option, within the warranty period of any component part which we at our discretion determines to contain faulty materials or a manufacturing defect in breach of this warranty. This warranty is subject to terms and conditions set out in this certificate.
3. The warranty only applies within New Zealand.
4. The customer must produce the original invoice or other purchase documentation as proof of the original purchase date.

Warranty exclusions

1. The warranty does not apply where, in Parbury's opinion:
The defect is caused by misuse, wear and tear, dirt, fire or accidental damage.
The product has been repaired or serviced by an unauthorised person.
The product was not installed in accordance with our instructions.
The product was purchased overseas or was not designed for use in New Zealand.
The product was not used, cleaned or cared for in accordance with our instructions.
The product was used outdoors.
All Robinhood rangehoods are suitable for indoor use only, and not suitable over BBQs or charcoal cookers designed for outdoor use.
2. In addition, this warranty does not extend to damage or defects which in our opinion, directly or indirectly arise from or
Exposing the product to acidic or corrosive materials or chemicals such as dyes, solvents, denture cleaner or acetone;
Using inappropriate household cleaning products such as abrasive cream or powder cleansers, furniture polish, bleach, mentholated spirits, drain cleaners, sugar soap, metal pads and strongly alkaline or acidic cleaners;
Heat damage, including from washing the product at high temperatures;
Impact or mishandling the product, including the impact caused by objects scraped along, thrown or dropped on the surface or excessive weight being placed on the product;
Structural or support changes in or affecting the building or the application where the product has been installed;
Failure to clean or maintain the product as recommended; or
Any other causes specified in the product information as being excluded from this warranty.
3. Variations with the colour or gloss within the product or any ageing or fading of colour, shine or gloss level over time are not covered by this warranty. The warranty does not cover visual imperfections or blemishes in the surface and edges of product that were not brought to your supplier's attention at the time you inspected the product.
4. Costs incurred on installation or removal of a product, or any reinstallation of a product, or any associated costs, are not covered by this warranty.
5. Parbury will not be liable for consequential or indirect loss or damage whatsoever and however arising out of or in with the supply, performance or removal of the product, including (but not limited to) loss of profit, loss of revenue, loss of contract, loss of goodwill or increased cost of workings, even if due to the negligence of Parbury or any of its approved suppliers, employees or agents.
6. Charcoal filters and light bulbs are not covered by this warranty
7. This warranty and the statements contained in this certificate or other documents given to you do not exclude, restrict or modify the application of any term implied into this warranty by statute, provided that (to the extent any statutory permits Parbury to limit its liability for a breach of an implied condition or warranty) Parbury's liability for such breach is to the payment of the cost of replacing the product, repairing the product or acquiring an equivalent product.
8. Subject to clause 5, our obligations under this warranty are limited to those set out in this certificate, and this warranty is expressly instead of all other warranties, express or implied, including any implied warranty of merchantability or fitness particular purpose and notwithstanding any course of dealing between the parties or custom and usage in trade to the contrary.

Should warranty service be required, please contact us:

Free Phone: 0800 760 667

Free Fax: 0800 276 246

Email: enquiries@robinhood.co.nz

Website: www.robinhood.co.nz

Terms and conditions are subject to change without notice

Warranty Certificate (Australia)

Terms and Conditions

If you are a consumer under the Australian Consumer Law, our goods come with guarantees that cannot be excluded under the Australian Consumer Law. You are entitled to a replacement or refund for a major failure and for compensation for any other reasonably foreseeable loss or damage. You are also entitled to have the goods repaired or replaced if the goods fail to be of acceptable quality and the failure does not amount to a major failure

1. Parbury Pty Limited ("Parbury") also warrants the following Robinhood products against manufacturing defects and faulty materials, under normal use and subject to the exclusions in this certificate, for a period of:

Rangehood, Ovens, Cooktops - 24 months from date of original purchase for domestic use.

Uniduct – 12 months from date of original purchase for domestic use.

Ironing centre – 12 months from date of original purchase for domestic use.

Taps, including Pull-out and Mixer taps – 5 years on parts only from date of original purchase domestic for use, 24 months parts and labour from date of original purchase for domestic use

Sinks sets– 5 years on stainless steel sink including draining bench from date of original purchase for domestic use, 6 months on all stainless steel accessories, including wire rack, colander and tray from date of original purchase for domestic use.

Supertub - 5 years on stainless bowl, 24 months on Tap, Cabinet and other components from the date of original purchase for domestic use.

"Original purchase", when used in this certificate, means purchase by the customer directly from Parbury or one of its approved suppliers.

2. This warranty is limited to the repair or replacement, at our option, within the warranty period of any component part which we at our discretion determine to contain faulty materials or a manufacturing defect in breach of this warranty. This warranty is subject to terms and conditions set out in this certificate.

3. The warranty only applies within Australia.

4. For warranty service outside of capital city metropolitan area or 30 km from nearest authorised service agent you will be liable for reasonable travelling expenses and the cost of transport of the product or parts to and from the service agent

5. To make a claim under this warranty, you must produce the original invoice or other purchase documentation as proof of the original purchase date. You must send your claim to Parbury Pty Limited, 76 Postle Street, Coopers Plains QLD 4108 within 7 days of any alleged defect or failure of the product first becoming apparent, you are responsible for the expense of making a claim under this warranty.

This warranty is given by:

Parbury Pty Ltd

ABN 83 004 568 138

Telephone: 1800 648 556

Facsimile: 1800 628 577

Email: enquiries@robinhood.com.au

www.robinhood.com.au

Attention Customer Services Manager

Warranty exclusions

1. The warranty does not apply where, in Parbury's opinion:

The defect is caused by misuse, wear and tear, dirt, fire or accidental damage.

The product has been repaired or serviced by an unauthorised person.

The product was not installed in accordance with our instructions.

The product was purchased overseas or was not designed for use in Australia.

The product was not used, cleaned or cared for in accordance with our instructions.

The product was used outdoors.

2. All Robinhood rangehoods are suitable for indoor use only and not suitable over BBQs or charcoal cookers designed for outdoor use.

3. In addition, this warranty does not extend to damage or defects which in our opinion, directly or indirectly arise from or are due to: exposing the product to acidic or corrosive materials or chemicals such as dyes, solvents, denture cleaner or acetone; using inappropriate household cleaning products such as abrasive cream or powder cleansers, furniture polish, bleach, mentholated spirits, drain cleaners, sugar soap, metal pads and strongly alkaline or acidic cleaners; heat damage, including from washing the product at high temperatures;

impact or mishandling the product, including the impact caused by objects scraped along, thrown or dropped on the product surface or excessive weight being placed on the product; structural or support changes in or affecting the building or the application where the product has been installed; failure to clean or maintain the product as recommended; or any other causes specified in the product information as being excluded from this warranty.

4. Variations with the colour or gloss within the product or any ageing or fading of colour, shine or gloss level over time are not covered by this warranty. The warranty does not cover visual imperfections or blemishes in the surface and edges of the product that were not brought to your supplier's attention at the time you inspected the product.

5. We will not be responsible under this warranty for, nor pay the costs of, removing the existing product, or reinstalling the new product, or any associated costs or damages.

6. Charcoal filters and light bulbs are not covered by this warranty

The benefits given by this warranty are in addition to other rights and remedies of consumers under any law in relation to the goods which cannot be excluded.

This warranty certificate is not intended to create a contract between Parbury Pty Limited and the purchaser.

New Zealand

Parbury Pty Ltd

Telephone: 0800 760 667

Facsimile: 0800 276 246

Email: enquiries@robinhood.co.nz

www.robinhood.co.nz

Australia

Parbury Pty Ltd

ABN 83 004 568 138

Telephone: 1800 648 556

Facsimile: 1800 628 577

Email: enquiries@robinhood.com.au

www.robinhood.com.au

