

GB

English, 1

IWDC 7125

 This symbol reminds you to read this instruction manual.

GB

## Contents

### Installation, 2-3

Unpacking and levelling  
Connecting the electricity and water supplies  
The first wash cycle  
Technical data

### Care and maintenance, 4

Cutting off the water or electricity supply  
Cleaning the washer-dryer  
Cleaning the detergent dispenser drawer  
Caring for the door and drum of your appliance  
Cleaning the pump  
Checking the water inlet hose

### Precautions and tips, 5

General safety  
Disposal

### Description of the washer-dryer and starting a wash cycle, 6-7

Control panel  
Indicator lights  
Starting a wash cycle

### Wash cycles, 8

Table of wash cycles

### Personalisation, 9

Setting the temperature  
Setting the drying cycle  
Functions

### Detergents and laundry, 10

Detergent dispenser drawer  
Preparing the laundry  
Garments requiring special care  
Load balancing system

### Troubleshooting, 11

### Service, 12

# Installation

GB

! This instruction manual should be kept in a safe place for future reference. If the washer-dryer is sold, transferred or moved, make sure that the instruction manual remains with the machine so that the new owner is able to familiarise himself/herself with its operation and features.

! Read these instructions carefully: they contain vital information relating to the safe installation and operation of the appliance.

## Unpacking and levelling

### Unpacking

1. Remove the washer-dryer from its packaging.
2. Make sure that the washer-dryer has not been damaged during the transportation process. If it has been damaged, contact the retailer and do not proceed any further with the installation process.

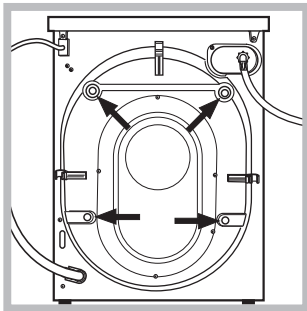

3. Remove the 4 protective screws (used during transportation) and the rubber washer with the corresponding spacer, located on the rear part of the appliance (see figure).

4. Close off the holes using the plastic plugs provided.
5. Keep all the parts in a safe place: you will need them again if the washer-dryer needs to be moved to another location.

! Packaging materials should not be used as toys for children.

### Levelling

1. Install the washer-dryer on a flat sturdy floor, without resting it up against walls, furniture cabinets or anything else.

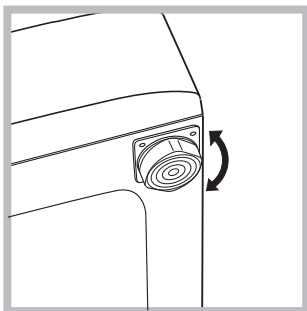

2. If the floor is not perfectly level, compensate for any unevenness by tightening or loosening the adjustable front feet (see figure); the angle of inclination, measured in relation to the worktop, must not exceed 2°.

Levelling the machine correctly will provide it with stability, help to avoid vibrations and excessive noise and prevent it from shifting while it is operating. If it is placed on carpet or a rug, adjust the feet in such a way as to allow a sufficient ventilation space underneath the washer-dryer.

## Connecting the electricity and water supplies

### Connecting the water inlet hose

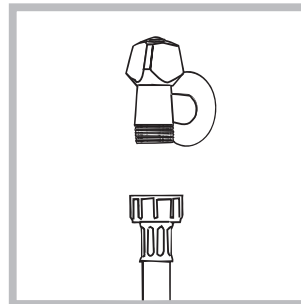

1. Connect the supply pipe by screwing it to a cold water tap using a  $\frac{3}{4}$  gas threaded connection (see figure). Before performing the connection, allow the water to run freely until it is perfectly clear.

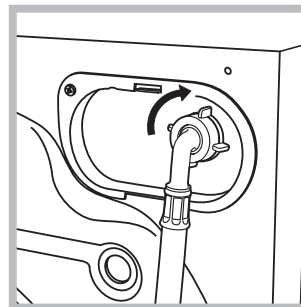

2. Connect the inlet hose to the washer-dryer by screwing it onto the corresponding water inlet of the appliance, which is situated on the top right-hand side of the rear part of the appliance (see figure).

3. Make sure that the hose is not folded over or bent.

! The water pressure at the tap must fall within the values indicated in the Technical details table (see next page).

! If the inlet hose is not long enough, contact a specialised shop or an authorised technician.

! Never use second-hand hoses.

! Use the ones supplied with the machine.

## Connecting the drain hose

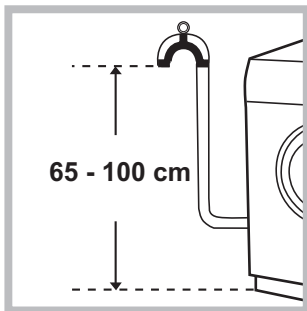

Connect the drain hose, without bending it, to a drainage duct or a wall drain located at a height between 65 and 100 cm from the floor;

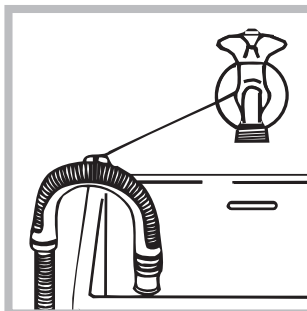

alternatively, rest it on the side of a washbasin or bathtub, fastening the duct supplied to the tap (see figure). The free end of the hose should not be underwater.

! We advise against the use of hose extensions; if it is absolutely necessary, the extension must have the same diameter as the original hose and must not exceed 150 cm in length.

## Electrical connection

Before inserting the plug into the electrical socket, make sure that:

- the socket is earthed and complies with current regulations;
- the socket can withstand the maximum load of the appliance, which is indicated in the Technical data table (see opposite);
- the power supply voltage falls within the values indicated in the Technical data table (see opposite);
- the socket is compatible with the plug of the appliance. If this is not the case, either the socket or the plug must be replaced.

! The machine must not be installed outdoors, even in covered areas. It is extremely dangerous to leave the appliance exposed to rain, storms and other weather conditions.

! Once the machine has been installed, the electricity socket should be easily accessible.

! Avoid using any extension cord or multiple socket outlet.

**! CAUTION:** if this appliance is supplied from a cord extension set or electrical portable outlet device, the cord extension set or electrical portable outlet device must be positioned so that it is not subject to splashing or ingress of moisture.



! The cable should not be bent or compressed.

! The cable should be replaced only by authorised technicians.

! If the supply cord is damaged, it must be replaced by the manufacturer, its service agent or similarly qualified persons in order to avoid a hazard. Warning! The company shall not be held responsible for any incidents that occur if these regulations are not observed.

## The first wash cycle

Once the appliance has been installed, and before you use it for the first time, run a wash cycle with detergent and no laundry, using the wash cycle **2**.

Technical data	
<b>Model</b>	IWDC 7125
<b>Dimensions</b>	width 59.5 cm height 85 cm depth 53,5 cm
<b>Capacity</b>	from 1 to 7,5 kg for the wash programme; from 1 to 4,5 kg for the drying programme
<b>Electrical connections</b>	please refer to the technical data plate fixed to the machine
<b>Water connections</b>	maximum pressure 1 MPa (10 bar) minimum pressure 0.05 MPa (0.5 bar) drum capacity 52 litres
<b>Spin speed</b>	up to 1200 rotations per minute
<b>Energy rated programmes according to:</b> - AS/NZS 2040.2 (washing) - AS/NZS 2442.2 (drying)	<b>Wash:</b> programme 2; temperature 60°C at 1200 rpm; run with a load of 7,5 kg. <b>Drying:</b> the smaller load (2kg) must be dried by selecting the “☒” dryness level. The load must consist of 2 sheets, 1 pillowcase and 1 hand towel; the remainder of the load must be dried by selecting the “☒” dryness level.
 	This appliance conforms to the following EC Directives: - 89/336/EEC dated 03/05/89 (Electromagnetic Compatibility) and subsequent modifications - 2012/19/EU (WEEE) - 2006/95/EC Low Voltage)

# Care and maintenance

GB

## Cutting off the water and electricity supplies

- Turn off the water tap after every wash cycle. This will limit wear on the hydraulic system inside the washer-dryer and help to prevent leaks.
- Unplug the washer-dryer when cleaning it and during all maintenance work.

## Cleaning the washer-dryer

The outer parts and rubber components of the appliance can be cleaned using a soft cloth soaked in lukewarm soapy water. Do not use solvents or abrasives.

## Cleaning the detergent dispenser drawer

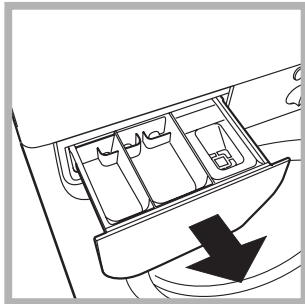

Remove the dispenser by raising it and pulling it out (see figure). Wash it under running water; this operation should be repeated frequently.

## Caring for the door and drum of your appliance

- Always leave the porthole door ajar in order to prevent unpleasant odours from forming.

## Cleaning the pump

The washer-dryer is fitted with a self-cleaning pump which does not require any maintenance. Sometimes, small items (such as coins or buttons) may fall into the pre-chamber which protects the pump, situated in its bottom part.

- ! Make sure the wash cycle has finished and unplug the appliance.

To access the pre-chamber:

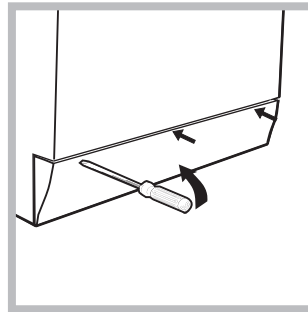

1. using a screwdriver, remove the cover panel on the lower front part of the washer-dryer (see figure);

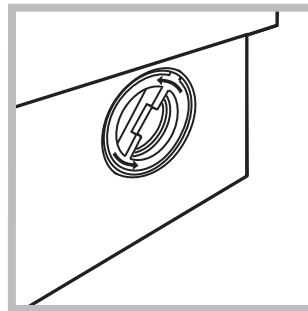

2. unscrew the lid by rotating it anti-clockwise (see figure); a little water may trickle out. This is perfectly normal;

3. clean the inside thoroughly;
4. screw the lid back on;
5. reposition the panel, making sure the hooks are securely in place before you push it onto the appliance.

## Checking the water inlet hose

Check the inlet hose at least once a year. If there are any cracks, it should be replaced immediately: during the wash cycles, water pressure is very strong and a cracked hose could easily split open.

- ! Never use second-hand hoses.

! This Washer-dryer was designed and constructed in accordance with international safety regulations. The following information is provided for safety reasons and must therefore be read carefully.

## General safety

- This appliance can be used by children aged from 8 years and above and persons with reduced physical, sensory or mental capabilities or lack of experience and knowledge if they have been given supervision or instruction concerning use of the appliance in a safe way and understand the hazards involved. Children shall not play with the appliance. Cleaning and user maintenance shall not be made by children without supervision.
  - Do not dry unwashed items in the tumble dryer.
  - Items that have been soiled with substances such as cooking oil, acetone, alcohol, petrol, kerosene, spot removers, turpentine, waxes and wax removers should be washed in hot water with an extra amount of detergent before being dried in the tumble dryer.
  - Items such as foam rubber (latex foam), shower caps, waterproof textiles, rubber backed articles and clothes or pillows fitted with foam rubber pads should not be dried in the tumble dryer.
  - Fabric softeners, or similar products, should be used as specified by the fabric softener instructions.
  - The final part of a tumble dryer cycle occurs without heat (cool down cycle) to ensure that the items are left at a temperature that ensures that the items will not be damaged.

**WARNING:** Never stop a tumble dryer before the end of the drying cycle unless all items are quickly removed and spread out so that the heat is dissipated.

- This appliance was designed for domestic use only.
- Do not touch the machine when barefoot or with wet or damp hands or feet.
- Do not pull on the power supply cable when unplugging the appliance from the electricity socket. Hold the plug and pull.
- Do not open the detergent dispenser drawer while the machine is in operation.
- Do not touch the drained water as it may reach extremely high temperatures.
- Never force the porthole door. This could damage the safety lock mechanism designed to prevent accidental opening.
- If the appliance breaks down, do not under any circumstances access the internal mechanisms in an attempt to repair it yourself.
- Always keep children well away from the appliance while it is operating.

- The door can become quite hot during the wash cycle.
- If the appliance has to be moved, work in a group of two or three people and handle it with the utmost care. Never try to do this alone, because the appliance is very heavy.
- Before loading laundry into the Washer-dryer, make sure the drum is empty.
- During the drying phase, the door tends to get quite hot.
- Do not use the appliance to dry clothes that have been washed with flammable solvents (e.g. trichlorethylene).
- Do not use the appliance to dry foam rubber or similar elastomers.
- Make sure that the water tap is turned on during the drying cycles.
- Children of less than 3 years should be kept away from the appliance unless continuously supervised.
- Remove all objects from pockets such as lighters and matches.

## Disposal

- Disposing of the packaging materials: observe local regulations so that the packaging may be re-used.
- The European Directive 2012/19/EU - WEEE on Waste Electrical and Electronic Equipment, requires that old household electrical appliances must not be disposed of in the normal unsorted municipal waste stream. Old appliances must be collected separately in order to optimise the recovery and recycling of the materials they contain and reduce the impact on human health and the environment. The crossed out "wheeled bin" symbol on the product reminds you of your obligation, that when you dispose of the appliance it must be separately collected. Consumers should contact their local authority or retailer for information concerning the correct disposal of their old appliance.

# Description of the washer-dryer and starting a wash cycle

## Control panel

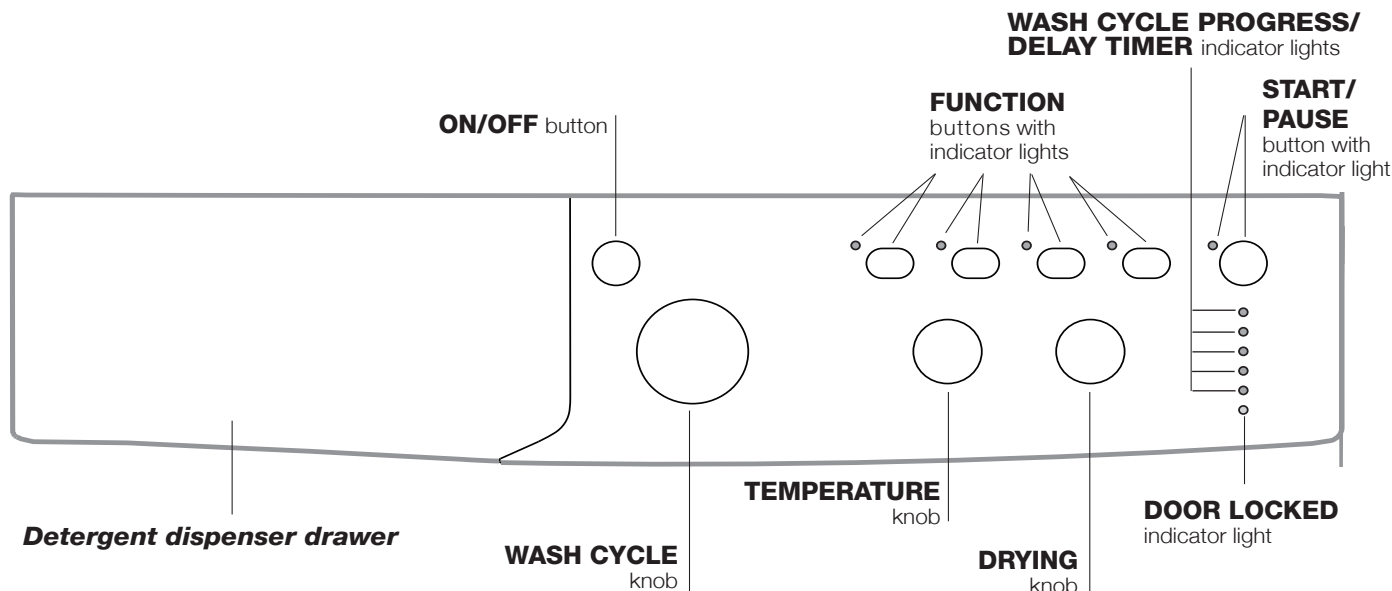

**Detergent dispenser drawer:** used to dispense detergents and washing additives (see “Detergents and laundry”).

**ON/OFF button:** switches the washer-dryer on and off.

**WASH CYCLE knob:** programmes the wash cycles. During the wash cycle, the knob does not move.

**FUNCTION buttons with indicator light:** used to select the available functions. The indicator light corresponding to the selected function will remain lit.

**TEMPERATURE knob:** sets the temperature or the cold wash cycle (see “Personalisation”).

**DRYING knob:** used to set the desired drying programme (see “Personalisation”).

**WASH CYCLE PROGRESS/DELAY TIMER indicator lights:** used to monitor the progress of the wash cycle. The illuminated indicator light shows which phase is in progress. If the Delay Timer function has been set, the time remaining until the wash cycle starts will be indicated (see next page).

**DOOR LOCKED indicator light:** indicates whether the door may be opened or not (see next page).

**START/PAUSE button with indicator light:** starts or temporarily interrupts the wash cycles.

**N.B.** To pause the wash cycle in progress, press this button; the corresponding indicator light will flash orange, while the indicator light for the current wash cycle phase will remain lit in a fixed manner. If the DOOR LOCKED  indicator light is switched off, the door may be opened (wait approximately 3 minutes).

To start the wash cycle from the point at which it was interrupted, press this button again.

### Standby mode

This washing machine, in compliance with new energy saving regulations, is fitted with an automatic standby system which is enabled after a few minutes if no activity is detected. Press the ON-OFF button briefly and wait for the machine to start up again.

*Consumption in off-mode: 0,5 W*

*Consumption in Left-on: 8 W*

## Indicator lights

The indicator lights provide important information. This is what they can tell you:

### Delayed start

If the DELAY TIMER function has been activated (see “Personalisation”), after the wash cycle has been started the indicator light corresponding to the selected delay period will begin to flash:

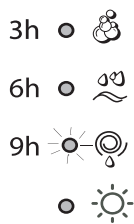

As time passes, the remaining delay will be displayed and the corresponding indicator light will flash:

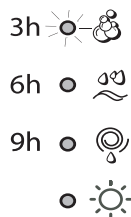

The set programme will start once the selected time delay has expired.

## Starting a wash cycle





1. Switch the washer-dryer on by pressing the ON/OFF button. All indicator lights will switch on for a few seconds, then they will switch off and the START/PAUSE indicator light will pulse.
2. Load the laundry and close the door.
3. Set the WASH CYCLE knob to the desired programme.
4. Set the washing temperature (see “Personalisation”).
5. Set the drying cycle if necessary (see “Personalisation”).
6. Measure out the detergent and washing additives (see “Detergents and laundry”).
7. Select the desired functions.
8. Start the wash cycle by pressing the START/PAUSE button and the corresponding indicator light will remain lit in a fixed manner, in green.

To cancel the set wash cycle, pause the machine by pressing the START/PAUSE button and select a new cycle.

9. At the end of the wash cycle the **END** indicator light will switch on. The door can be opened once the DOOR LOCKED  indicator light turns off (wait approximately 3 minutes). Take out your laundry and leave the appliance door ajar to make sure the drum dries completely. Switch the washer-dryer off by pressing the ON/OFF button.

## Wash cycle phase indicator lights

Once the desired wash cycle has been selected and has begun, the indicator lights switch on one by one to indicate which phase of the cycle is currently in progress.

Wash	
Rinse	
Spin/Drain	
Drying	
End of wash cycle	

**Note:** when the drying cycle has finished, the DRYING knob should be returned to the “0” position.

## Function buttons and corresponding indicator lights

When a function is selected, the corresponding indicator light will illuminate.

If the selected function is not compatible with the programmed wash cycle, the corresponding indicator light will flash and the function will not be activated.

If the selected function is not compatible with another function which has been selected previously, the indicator light corresponding to the first function selected will flash and only the second function will be activated; the indicator light corresponding to the enabled option will remain lit.



## Door locked indicator light

When the indicator light is on, the porthole door is locked to prevent it from being opened; make sure the indicator light is off before opening the door (wait approximately 3 minutes). To open the door during a running wash cycle, press the START/PAUSE button; the door may be opened once the DOOR LOCKED indicator light turns off.

# Wash cycles

GB

**Table of wash cycles**

Wash cycles	Description of the wash cycle	Max. temp. (°C)	Max. speed (rpm)	Drying	Detergents			Max. load (kg)	Cycle duration
					Prewash	Main wash	Fabric softener		
<b>Daily</b>									
1	<b>White prewash:</b> extremely soiled whites.	90°	1200	●	●	●	●	7,5	170'
2	<b>White cotton:</b> extremely soiled whites.	90°	1200	●	-	●	●	7,5	160'
2	<b>White cotton (1):</b> normal soiled whites and resistant colours.	60°	1200	●	-	●	●	7,5	230'
2	<b>White cotton (2):</b> heavily soiled whites and delicate colours.	40°	1200	●	-	●	●	7,5	220'
3	<b>Cotton:</b> heavily soiled whites and resistant colours.	60°	1200	●	-	●	●	7,5	140'
4	<b>Coloured cotton:</b> lightly soiled whites and delicate colours.	40°	1200	●	-	●	●	7,5	90'
5	<b>White nylon:</b> heavily soiled resistant colours.	60°	800	●	-	●	●	3	115'
<b>Special</b>									
6	<b>Wool:</b> for wool, cashmere, etc.	40°	800	-	-	●	●	1,5	70'
7	<b>Silk/Curtains:</b> for garments in silk and viscose, lingerie.	30°	0	-	-	●	●	1	55'
8	<b>Jeans</b>	40°	800	●	-	●	●	3,5	75'
9	<b>Sport Light</b>	30°	600	-	-	●	●	2,5	60'
10	<b>Special Shoes</b>	30°	600	-	-	●	●	Max. 2 pairs	60'
<b>Dry</b>									
11	<b>Cotton</b>	-	-	●	-	-	-	5	-
12	<b>Synthetics</b>	-	-	●	-	-	-	3	-
13	<b>Express Wash&amp;Dry</b>	30°	1200	●	-	●	●	0,5	30'
<b>Partial wash cycles</b>									
	Rinse	-	1200	●	-	-	●	7,5	36'
	Spin	-	1200	●	-	-	-	7,5	10'
	Drain	-	0	-	-	-	-	7,5	3'

The length of cycle shown on the display or in this booklet is an estimation only and is calculated assuming standard working conditions. The actual duration can vary according to factors such as water temperature and pressure, the amount of detergent used, the amount and type of load inserted, load balancing and any wash options selected.

**For all Test Institutes:**

1) **Test wash cycle in compliance with regulation AS/NZS 2040.2:** set wash cycle 2 with a temperature of 60°C at 1200 rpm and Drying test in compliance with AS/NZ 2442.2 set at  dryness level.

2) **Long wash cycle for cottons:** set wash cycle 2 with a temperature of 40°C.

**Specials wash cycles**

**Sport Light** (wash cycle 9) is for washing lightly soiled sports clothing fabrics (tracksuits, shorts, etc.); for best results, we recommend not exceeding the maximum load indicated in the "Table of wash cycles". We recommend using a liquid detergent and dosage suitable for a half-load.

**Special Shoes** (wash cycle 10) is for washing sports shoes; for best results, do not wash more than 2 pairs (fabric) simultaneously.

**Express Wash&Dry** (wash cycle 13) was designed to wash and dry lightly soiled garments quickly. This cycle may be used to wash and dry a laundry load of up to 0.5 kg in just 35 minutes.

To achieve optimum results, use liquid detergent and pre-treat cuffs, collars and stains.



## Setting the temperature

Turn the TEMPERATURE knob to set the wash temperature (see *Table of wash cycles*).

The temperature may be lowered, or even set to a cold wash ❄️. The washer-dryer will automatically prevent you from selecting a temperature which is higher than the maximum value set for each wash cycle.

## Setting the drying cycle

Turn the DRYING knob to select the desired drying option. There are two options:

**A** - Based on time: From **40** minutes to **180**.

**B** - Based on the desired laundry dryness level:

*Iron dry* 🧺: suitable for clothes which will need ironing afterwards. the remaining dampness softens creases, making them easier to remove.

*Hanger dry* 🧺: ideal for clothes which do not need to be dried fully.

*Cupboard dry* 🧺: suitable for laundry which can be put back in a cupboard without being ironed.

If your laundry load to be washed and dried is much greater than the maximum stated load (see adjacent table), perform the wash cycle, and when the cycle is complete, divide the garments into groups and put some of them back in the drum. At this point, follow the instructions provided for a “**Drying only**” cycle. Repeat this procedure for the remainder of the load.

### Drying only

Use the cycle selector knob to select a drying cycle (**11-12**) in accordance with the type of fabric. The desired drying level or time may also be set using the DRYING knob.

## Functions

The various wash functions available with this washer-dryer will help to achieve the desired results, every time.

To activate the functions:

1. Press the button corresponding to the desired function;
2. the function is enabled when the corresponding indicator light is illuminated.

### Note:

- If the selected function is not compatible with the programmed wash cycle, the corresponding indicator light will flash and the function will not be activated.
- If the selected function is not compatible with another function which has been selected previously, the indicator light corresponding to the first function selected will flash and only the second function will be activated; the indicator light corresponding to the enabled option will remain lit.

### EcoTime

Selecting this option enables you to suitably adjust drum rotation, temperature and water to a reduced load of lightly soiled cotton and synthetic fabrics (refer to the “*Table of wash cycles*”). “EcoTime” enables you to wash in less time thereby saving water and electricity. We suggest using a liquid detergent suitably measured out to the load quantity.

### 🌀 1200-600

Press this button to reduce the spin speed.

### 🧺 Easy iron

By selecting this function, the wash and spin cycles will be modified in order to reduce the formation of creases. At the end of the cycle the Washer-dryer will perform slow rotations of the drum; the indicator lights for the EASY IRON and START/PAUSE options will flash (the first one green, the second orange) and the “**END**” indicator light turns on. To end the cycle, press the START/PAUSE button or the EASY IRON button.

For the 7 wash cycle, the machine will end the cycle while the laundry is soaking and the EASY IRON and START/PAUSE indicator lights will flash. To drain the water so that the laundry may be removed, press the START/PAUSE button or the EASY IRON button.

**Note:** If you also want to run the drying cycle, this option is enabled only if combined with level 🧺 (Iron dry).

### 🕒 Delay timer

This timer delays the start time of the wash cycle by up to 9 hours. Press the button repeatedly until the indicator light corresponding to the desired delay time switches on. The fourth time the button is pressed, the function will be disabled.

**N.B.** Once the START/PAUSE button has been pressed, the delay time can only be modified by decreasing it until launching the set programme.

**Table of Drying times (guideline values)**

Fabric type	Load type	Max. load (kg)	Cupboard dry 🧺	Hanger dry 🧺	Iron dry 🧺
Cotton	Clothing of different sizes, Terry towels	4,5	250	210	190
Synthetic	Sheets, Shirts, Py-jamas, socks, etc.	3	180	130	115

# Detergents and laundry

GB

## Detergent dispenser drawer

Good washing results also depend on the correct dose of detergent: adding too much detergent will not necessarily result in a more efficient wash, and may in fact cause build up on the inside of your appliance and contribute to environmental pollution.

! Do not use hand washing detergents because these create too much foam.



Open the detergent dispenser drawer and pour in the detergent or washing additive, as follows.

**compartment 1: Pre-wash detergent (powder)**  
**compartment 2: Detergent for the wash cycle (powder or liquid)**

Liquid detergent should only be poured in immediately prior to the start of the wash cycle.

**compartment 3: Additives (fabric softeners, etc.)**

The fabric softener should not overflow the grid.

## Preparing the laundry

- Divide the laundry according to:
  - the type of fabric/the symbol on the label
  - the colours: separate coloured garments from whites.
- Empty all garment pockets and check the buttons.
- Do not exceed the values listed in the "Table of wash cycles", which refer to the weight of the laundry when dry.

### How much does your laundry weigh?

- 1 sheet 400-500 g
- 1 pillow case 150-200 g
- 1 tablecloth 400-500 g
- 1 bathrobe 900-1200 g
- 1 towel 150-250 g

## Garments requiring special care

**Wool:** all wool garments can be washed using programme 6, even those carrying the "hand-wash only"  label. For best results, use special detergents and do not exceed 1,5 kg of laundry.

**Silk:** use special wash cycle 7 to wash all silk garments. We recommend the use of special detergent which has been designed to wash delicate clothes.

**Curtains:** fold curtains and place them in a pillow case or mesh bag. Use wash cycle 7.

**Jeans:** Turn garments inside-out before washing and use a liquid detergent. Use programme 8.

## Load balancing system

Before every spin cycle, to avoid excessive vibrations and to distribute the load in a uniform manner, the drum rotates continuously at a speed which is slightly greater than the washing rotation speed. If, after several attempts, the load is not balanced correctly, the machine spins at a reduced spin speed. If the load is excessively unbalanced, the washer-dryer performs the distribution process instead of spinning. To encourage improved load distribution and balance, we recommend small and large garments are mixed in the load.

Your washer-dryer could fail to work. Before contacting the Technical Assistance Centre (see “Assistance”), make sure that the problem cannot be not solved easily using the following list.

## Problem:

## Possible causes / Solutions:

**The Washer-dryer does not switch on.**

- The appliance is not plugged into the socket fully, or is not making contact.
- There is no power in the house.

**The wash cycle does not start.**

- The Washer-dryer door is not closed properly.
- The ON/OFF button has not been pressed.
- The START/PAUSE button has not been pressed.
- The water tap has not been opened.
- A delayed start has been set.

**The Washer-dryer does not take in water (the indicator light for the first wash cycle stage flashes rapidly).**

- The water inlet hose is not connected to the tap.
- The hose is bent.
- The water tap has not been opened.
- There is no water supply in the house.
- The pressure is too low.
- The START/PAUSE button has not been pressed.

**The Washer-dryer continuously takes in and drains water.**

- The drain hose is not fitted at a height between 65 and 100 cm from the floor (see “Installation”).
- The free end of the hose is under water (see “Installation”).
- The wall drainage system is not fitted with a breather pipe.

If the problem persists even after these checks, turn off the water tap, switch the appliance off and contact the Assistance Service. If the dwelling is on one of the upper floors of a building, there may be problems relating to water drainage, causing the Washer-dryer to fill with water and drain continuously. Special anti-draining valves are available in shops and help to avoid this inconvenience.

**The Washer-dryer does not drain or spin.**

- The wash cycle does not include draining: some wash cycles require the drain phase to be started manually.
- The “Easy iron” option has been activated: To complete the wash cycle, press the START/PAUSE button (see “Wash cycles and options”).
- The drain hose is bent (see “Installation”).
- The drainage duct is clogged.

**The Washer-dryer vibrates a lot during the spin cycle.**

- The drum was not unlocked correctly during installation (see “Installation”).
- The Washer-dryer is not level (see “Installation”).
- The Washer-dryer is trapped between cabinets and walls (see “Installation”).

**The Washer-dryer leaks.**

- The water inlet hose is not screwed on properly (see “Installation”).
- The detergent dispenser drawer is blocked (for cleaning instructions, see “Care and maintenance”).
- The drain hose is not fixed properly (see “Installation”).

**The “functions” indicator lights and the “start/pause” indicator light flash, while one of the “phase in progress” indicator lights and the “door locked” indicator light will remain lit in a fixed manner.**

- Switch off the machine and unplug it, wait for approximately 1 minute and then switch it back on again.
- If the problem persists, contact the Technical Assistance Service.

**There is too much foam.**

- The detergent is not suitable for machine washing (it should display the text “for Washer-dryers” or “hand and machine wash”, or the like).
- Too much detergent was used.

**The washer-dryer does not dry.**

- The appliance is not plugged into the socket, or not enough to make contact.
- There has been a power failure.
- The appliance door is not shut properly.
- A delayed start has been set.
- DRYING knob is in the **0** position.

### **INDESIT SERVICE**

In the unlikely event that your product fails to work normally, contact (in Australia) our service team on:

Phone: (02) 8858 6493

or visit [www.indesit.net.au/service-enquiries](http://www.indesit.net.au/service-enquiries)

### **INDESIT SPARE PARTS**

A wide range of genuine accessories are available for your appliance.

For more information (Australia Only):

Phone: (02) 9714 3434

### **AUSTRALIA SALES**

BUSH AUSTRALIA PTY LTD

46-48 Buffalo Road, Gladesville NSW 2111

Phone: (02) 9714 3434

[www.indesit.net.au](http://www.indesit.net.au)