

---

ECI341

COFFEE MAKER  
Instruction for use



---

**DeLonghi**

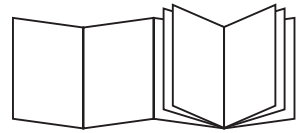

## ELECTRICAL REQUIREMENTS (UK ONLY)

Before using this appliance ensure that the voltage indicated on the product corresponds with the main voltage in your home, if you are in any doubt about your supply contact your local electricity company.

The flexible mains lead is supplied connected to a B.S. 1363 fused plug having a fuse of 13 amp capacity.

Should this plug not fit the socket outlets in your home, it should be cut off and replaced with a suitable plug, following the procedure outlined below.

Note: Such a plug cannot be used for any other appliance and should therefore be properly disposed of and not left where children might find it and plug it into a supply socket - with the obvious consequent danger.

N.B. We recommend the use of good quality plugs and wall sockets that can be switched off when the machine is not in use.

**IMPORTANT:** the wires in the mains lead fitted to this appliance are coloured in accordance with the following code:

GREEN AND YELLOW  
BLUE  
BROWN

EARTH  
NEUTRAL  
LIVE

Green and Yellow to Earth

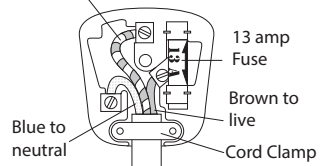

As the colours of the wires in the mains lead of this appliance may not correspond with the coloured markings identifying the terminals in your plug, proceed as follows:

- The wire which is coloured green and yellow must be connected to the terminal in the plug which is marked with the letter E or by the earth symbol  or coloured green or green and yellow.
- The wire which is coloured blue must be connected to the terminal which is marked with the letter N or coloured black.
- The wire which is coloured brown must be connected to the terminal which is marked with the letter L or coloured red.

When wiring the plug, ensure that all strands of wire are securely retained in each terminal. Do not forget to tighten the mains lead clamp on the plug. If your electricity supply point has only two pin socket outlets, or if you are in doubt, consult a qualified electrician.

Should the mains lead ever require replacement, it is essential that this operation be carried out by a qualified electrician and should only be replaced with a flexible cord of the same size.

After replacement of a fuse in the plug, the fuse cover must be refitted. If the fuse cover is lost, the plug must not be used until a replacement cover is obtained. The colour of the correct replacement fuse cover is that of the coloured insert in the base of the fuse recess or elsewhere on the plug. Always state this colour when ordering a replacement fuse cover.

Only 13amp replacement fuses which are approved to B.S. 1362 should be fitted.

This appliance conforms to the Norms EN 55014 regarding the suppression of radio interference.

**Warning - this appliance must be earthed**

**A**

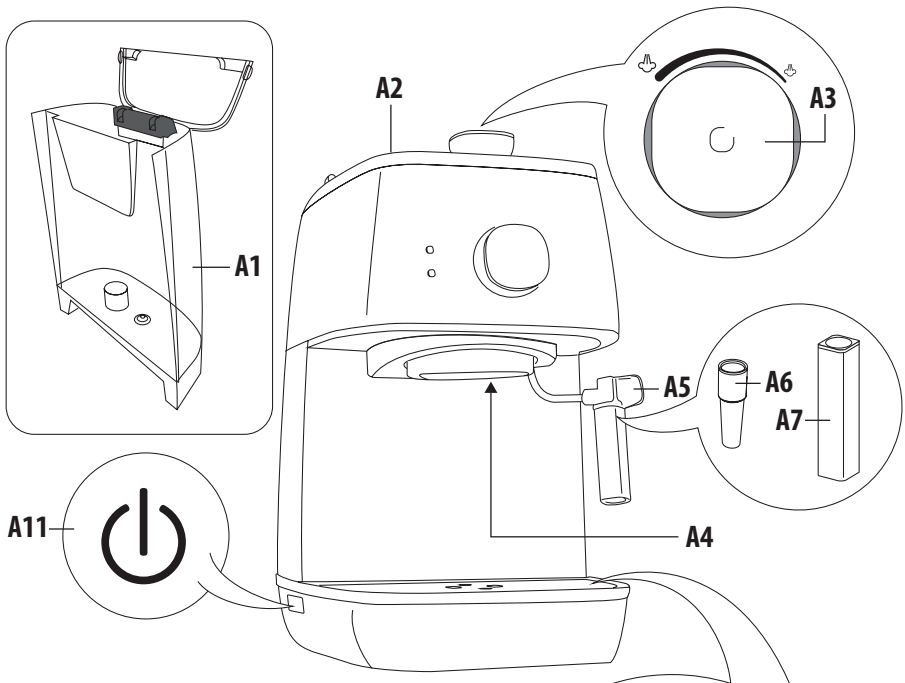

**B**

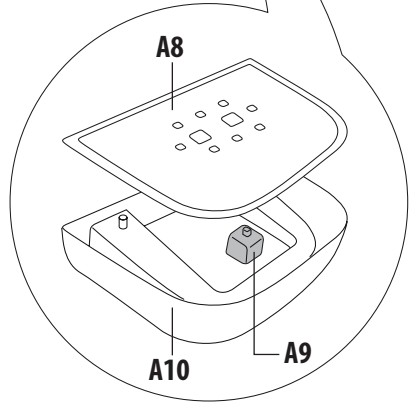
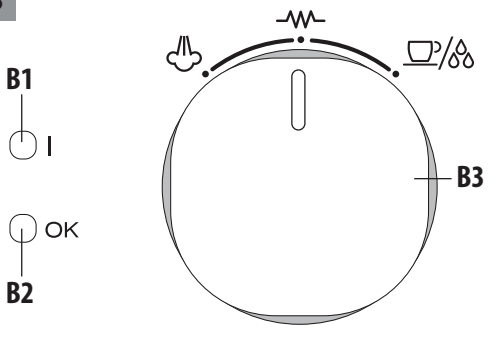

**C**

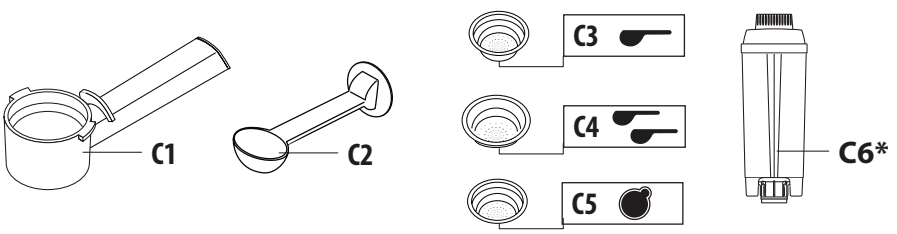

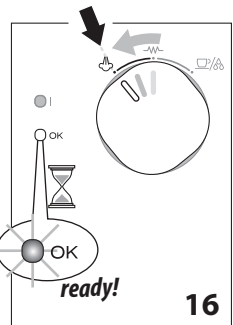
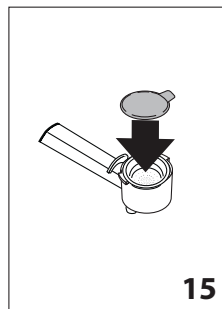
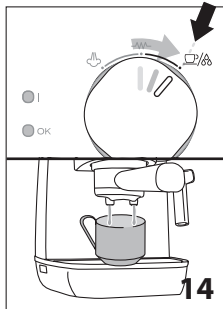
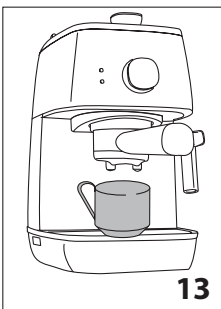
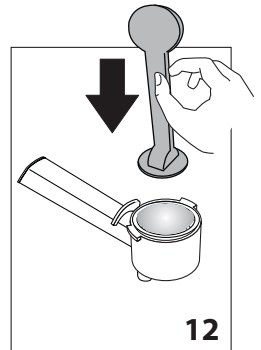
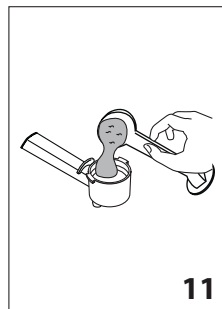
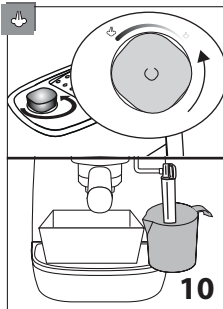
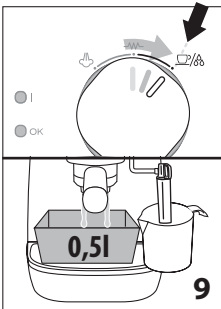
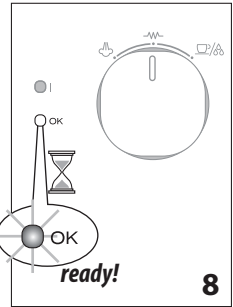
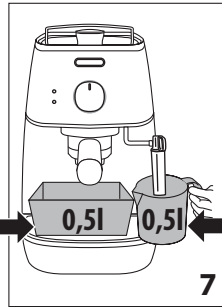
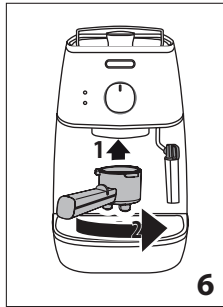
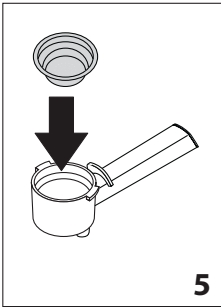
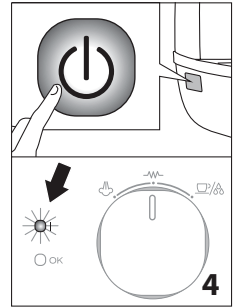
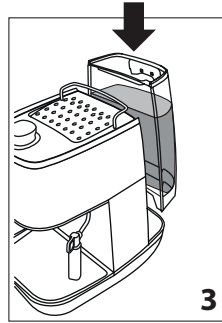
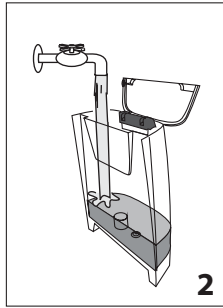
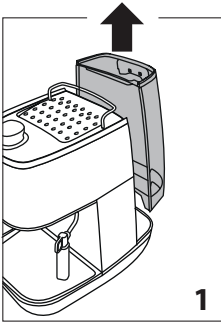

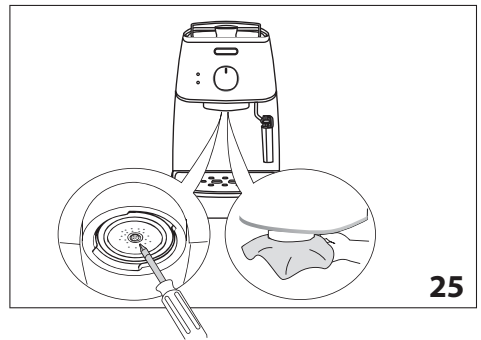
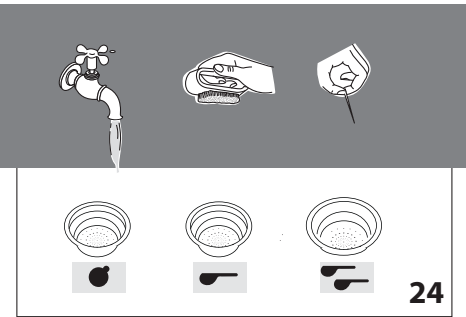
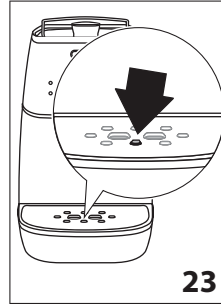
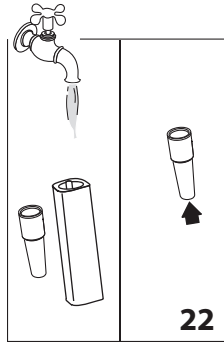
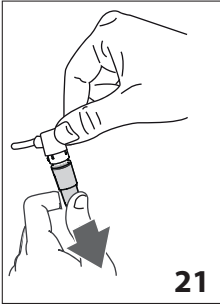
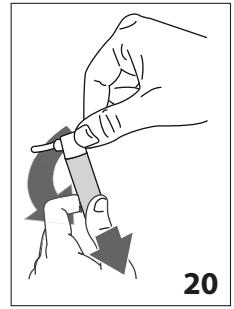
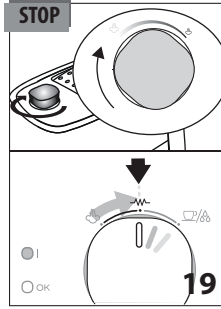
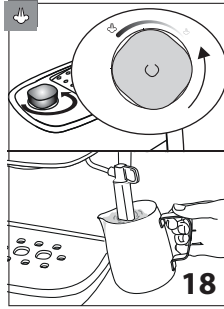
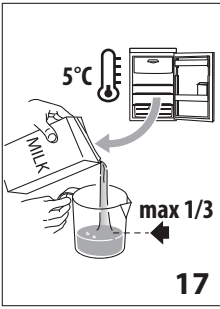

## FUNDAMENTAL SAFETY WARNINGS

---

- The appliance is not intended for use by persons (including children) with reduced physical, sensory or mental capabilities, or lack of experience and knowledge, unless they have been given supervision or instruction concerning use of the appliance by a person responsible for their safety.
- Children should be supervised to ensure that they do not play with the appliance. Cleaning and user maintenance shall not be made by children without supervision.
- Never clean by immersing the appliance in water.
- This is an household appliance only. It is not intended to be used in: staff kitchen areas in shops, offices and other working environments; farm houses; by clients in hotels, motels and other residential type environments; bed and breakfast type environments.
- If the plug or cord is damaged, it must be replaced by Customer Services only to avoid all risk.

### FOR EUROPEAN MARKETS ONLY:

- This appliance can be used by children aged from 8 years and above if they have been given supervision or instruction concerning use of the appliance in a safe way and if they understand the hazard involved. Cleaning and user maintenance shall not be made by children unless they are older than 8 and supervised. Keep the appliance and power cable away from children under eight years of age.
- Appliances can be used by persons with reduced physical, sensory or mental capabilities or lack of experience and knowledge if they are supervised or have been given instruction concerning use of the appliance in a safe way and if they understand the hazards involved. Children shall not play with the appliance.
- Always unplug the appliance when left unattended and before assembly, taking apart or cleaning.



Surfaces marked with this symbol become hot during use (the symbol is present in certain models only).

## IMPORTANT SAFEGUARDS



**Danger!** Failure to observe the warning may result in life threatening injury by electric shock.

This is an electrical appliance and may cause electrical shocks.

You should therefore follow these safety warnings:

- Never touch the appliance with damp hands or feet.
- Never touch the plug with damp hands.
- Make sure the socket used is freely accessible at all times, enabling the appliance to be unplugged when necessary.
- Unplug directly from the plug only. Never pull the cord as you could damage it.
- To disconnect the appliance completely you must unplug it from the mains socket.
- If the appliance is faulty, do not attempt to repair. Turn it off, unplug from the mains socket and contact Customer Services.
- Before cleaning the appliance, turn it off, unplug from the mains socket and allow to cool.



**Important:** Failure to observe the warning could result in injury or damage to the appliance.

Keep all packaging (plastic bags, polystyrene foam) away from children.



**Danger of burns!** Failure to observe the warning could result in scalds or burns.

This appliance produces hot water and steam may form while it is in operation.

Avoid contact with splashes of water or hot steam.

## Designated use

This appliance is designed and made to prepare coffee and heat drinks.

Any other use is considered improper and thus dangerous. The manufacturer is not liable for damage deriving from improper use of the appliance.

## Instruction for Use

Read this Instruction for Use carefully before using the appliance. Failure to follow this Instruction for Use may result in burns or damage to the appliance.

The manufacturer is not liable for damage deriving from failure to respect this Instruction for Use.



**Please note:**

Keep this Instruction for Use. If the appliance is passed to other persons, they must also be provided with this Instruction for Use.

## Checking the appliance

After removing the packaging, make sure the product is complete and undamaged and that all accessories are present. Do not use the appliance if it is visibly damaged. Contact De'Longhi Customer Services.

## DESCRIPTION

### Description of the appliance

(page 3 - A )

- A1. Water tank
- A2. Cup shelf
- A3. Steam dial
- A4. Boiler outlet
- A5. Steam/hot water spout
- A6. Nozzle
- A7. Cappuccino maker
- A8. Cup tray
- A9. Drip tray full indicator
- A10. Drip tray
- A11. ON/OFF switch

### Description of the control panel

(page 3 - B )

- B1. Power light
- B2. OK light
- B3. Selector dial

### Description of the accessories

(page 3 - C )

- C1. Filter holder
- C2. Measure/presser
- C3. 1 cup filter (☞ symbol under filter)
- C4. 2 cup filter (☞ symbol under filter)
- C5. Pod filter (● symbol under filter)
- C6. Water softener filter (\*not included, can be purchased from authorised Customer Services)

## INSTALLING THE APPLIANCE



**Important!**

When you install the appliance, you should respect the following safety warnings:

- Water penetrating the coffee machine could cause damage.  
Do not place the appliance near taps or sinks.
- The appliance could be damaged if the water it contains freezes.  
Do not install the appliance in a room where the temperature could drop below freezing point.

- Arrange the cord in such a way that it cannot be damaged by sharp edges or contact with hot surfaces (e.g. electric hot plates).
- The appliance gives off heat. After positioning the appliance on the worktop, leave a space of at least 3 cm between the surfaces of the appliance and the side and rear walls and at least 15 cm above the machine.

## Connecting the appliance



Check that the mains power supply voltage corresponds to that indicated on the rating plate on the bottom of the appliance. Connect the appliance to an efficiently earthed and correctly installed socket with a minimum current rating of 10A only. If the power socket does not match the plug on the appliance, have the socket replaced with a suitable type by a qualified professional.

## FILLING THE WATER TANK

1. Take out the tank by pulling upwards (fig. 1).
2. Fill the tank with fresh clean water, taking care not to exceed the MAX level indicated (fig. 2). Replace the tank (fig. 3), pressing lightly to open the valve located on the bottom of the tank.
3. More simply, the tank can also be filled without removing it, pouring the water directly from a jug.



Never operate the appliance without water in the tank or without the tank.



It is normal for there to be water in the space under the tank. This should therefore be dried regularly with a clean sponge.

## SETTING UP THE APPLIANCE

1. Turn the appliance on by pressing the ON/OFF button (fig. 4): the power light I comes on.
2. Insert the required coffee filter (fig. 5) in the filter holder.
3. Attach the filter holder onto the machine without filling it with ground coffee (fig. 6).
4. Place a 0.5 litre container under the boiler outlet and another 0.5 litre container under the cappuccino maker (fig. 7).
5. Wait until the OK light comes on (fig. 8) and immediately afterwards turn the selector to the ☐/☞ position (fig. 9) and let about half the tank discharge from the boiler outlet.

6. Then turn the steam dial anti-clockwise (fig. 10) and discharge all the water remaining in the tank from the cappuccino maker.
7. Close the steam valve in the – position and return the selector to the ☐/☞ (STAND-BY) position.
8. Empty the two containers and replace them under the boiler outlet and the cappuccino maker and repeat points 5-6-7.

Now the appliance is ready for use.

## Auto-off

If the appliance is not used for a certain period of time (which varies according to the model), it turns off automatically (the power light turns off).

## Tips for a hotter coffee

To make espresso coffee at the right temperature, the coffee maker should be preheated as follows:

1. Turn the appliance on by pressing the ON/OFF button (the ON light comes on) (fig. 4) and attach the filter holder onto the appliance without adding pre-ground coffee (fig. 6).
2. Place a cup under the filter holder. Use the same cup to be used later to prepare the coffee, in order to preheat it.
3. Wait until the OK light comes on (fig. 8) and immediately afterwards turn the selector dial to the ☐/☞ position (fig. 14) and let water discharge until the OK light turns off, then interrupt by turning the dial to the ☐/☞ position.
4. Empty the cup, wait until the OK light comes on again and then repeat the same operation.

(It is normal for a small and harmless puff of steam to be given off when removing the filter holder).

## HOW TO MAKE ESPRESSO COFFEE USING PRE-GROUND COFFEE

1. Place the ground coffee filter in the filter holder (fig. 5). To make one coffee, use the filter with the ☐ symbol on the bottom, to make two coffees, use the filter with the ☐/☞ symbol on the bottom.
2. To make just one coffee, place one level measure of pre-ground coffee (about 7 g) in the filter (fig. 11). To make two coffees, place two loosely filled measures (about 6+6 g) of pre-ground coffee in the filter. Fill the filter a little at a time to prevent the pre-ground coffee from overflowing.



**Important:** For correct operation, before filling with pre-ground coffee, make sure there are no coffee residues left in the filter from the last time you made coffee.

3. Distribute the pre-ground coffee evenly and press lightly with the presser (fig. 12). Correct pressing of the pre-ground coffee is essential to obtain a good espresso. If



pressing is excessive, coffee delivery will be slow and the froth will be dark. If pressing is too light, coffee delivery will be too rapid and the froth will be skimpy and light coloured.

4. Remove any excess coffee from the rim of the filter holder and attach to the appliance. Turn the handle firmly towards the right (fig. 6) to avoid water leaking out.
5. Place the cup or cups under the filter holder spouts (fig. 13). You are recommended to warm the cups before making coffee by rinsing them with a little hot water.
6. Make sure the OK light (fig. 8) is on (if off, wait until it comes on), then turn the selector to the ☐/☉ (fig. 13). position (fig. 13). When the desired amount of coffee has been delivered, turn the selector to the ⚡ to interrupt the flow.

**You should not deliver coffee for more than 45 seconds.**

7. To remove the filter holder, rotate the handle from right to left.



**Danger of burns!** To avoid splashes, never remove the filter holder while the appliance is delivering coffee.

8. To turn the appliance off, press the ON/OFF button.

## HOW TO PREPARE ESPRESSO COFFEE USING PODS

1. Preheat the appliance as described in the section "Tips for a hotter coffee", making sure the filter holder is attached. This obtains a hotter coffee.



**Please note:** Please note. Use pods conforming to the ESE standard, indicated on the pack by the following symbol. The ESE standard is a system accepted by leading pod producers and enables espresso coffee to be prepared simply and cleanly.

2. Place the filter for coffee pods (with the ☉ symbol on the bottom) in the filter holder.
3. Insert the pod, centring it as far as possible on the filter (fig. 15). Always follow the instructions on the pod pack to position the pod on the filter correctly.
4. Attach the filter holder to the appliance. Always turn as far as it will go (fig. 6).
5. Proceed as in points from 5 to 8 in the previous section.

## HOW TO MAKE CAPPUCCINO

1. Prepare the espresso coffees as described in the previous sections, using sufficiently large cups.
2. Turn the selector to the ☐ position (fig. 16) and wait until the OK light comes on.
3. In the meantime, fill a recipient with about 100 grams of milk for each cappuccino to be prepared. The milk must be

at refrigerator temperature (not hot!). In choosing the size of the recipient, bear in mind that the milk doubles or triples in volume (fig. 17).



**Please note:** You are recommended to use semi-skimmed milk and at refrigerator temperature.

4. Place the recipient containing the milk under the cappuccino maker.
5. Wait until the OK light comes on. This indicates that the boiler has reached the ideal temperature for steam production.
6. Open the steam turning counter-clockwise the steam dial for a few seconds to eliminate any water in the circuit. Close the steam.
7. Immerse the cappuccino maker in the milk about 5 mm (fig. 18) and turn the steam dial anti-clockwise (rotating the dial more or less varies the quantity of steam delivered by the cappuccino maker). The milk now starts to increase in volume and take on a creamy appearance.
8. When the milk has doubled in volume, immerse the cappuccino maker deeply and continue heating the milk. When the required temperature is reached (60°C is ideal), interrupt steam delivery by turning the steam dial clockwise and turn the selector to the ⚡ position (fig. 19).
9. Pour the frothed milk into the cups containing the espresso coffee prepared previously. The cappuccino is ready. Sweeten to taste and if desired, sprinkle the froth with a little cocoa powder.



**Please note:**

- To prepare more than one cappuccino, first make all the coffees then at the end prepare the frothed milk for all the cappuccinos.
- To make coffee again after the milk has been frothed, first cool the boiler, or the coffee will be burnt. To cool it place a container under the boiler outlet, turn the selector to the ☐/☉ position and discharge water until the OK light goes off. Return the selector to the ⚡ position and then proceed to make coffee.

**You are recommended to deliver steam for a maximum of 60 seconds and never to froth milk more than three times consecutively.**



**Important!** For hygiene reasons, the cappuccino maker should always be cleaned after use.

Proceed as follows:

1. Turn the steam dial to deliver a little steam for a few seconds (points 2, 5 and 6 of the previous section). This causes the cappuccino maker to discharge any milk left inside. Press the ON/OFF button to turn the appliance off.
2. With one hand, hold the cappuccino maker tube firmly, with the other, release the cappuccino maker by turning it clockwise, then pull off downwards (fig. 20).

3. Remove the rubber steam connection nozzle from the spout by pulling it downwards (fig.21).
4. Wash the cappuccino maker and steam connection nozzle thoroughly with warm water (fig. 22).
5. Clean the steam spout, taking care to avoid burns.
6. Replace the cappuccino maker by pushing upwards and turning anticlockwise.

## HOT WATER

1. Turn the appliance on by pressing the ON/OFF button (fig. 4). Wait the OK indicator light comes on.
2. Place a recipient under the cappuccino maker.
3. When the OK indicator light comes on, turn the selector dial to the ☐/☉ position and at the same time, rotate the steam dial anticlockwise. Hot water is delivered from the cappuccino maker.
4. To interrupt delivery of hot water, rotate the steam dial clockwise and position the selector dial to ⚡.

You should not deliver hot water for more than 60 seconds.

## CLEANING

 **Danger!** Before cleaning the outside of the appliance, turn it off, unplug from the mains socket and allow to cool.

### Cleaning the drip tray

 **Important!**

The drip tray is fitted with a level indicator (red) showing the level of water it contains (fig. 23). Before the indicator protrudes from the cup tray, the drip tray must be emptied and cleaned, otherwise the water may overflow the edge and damage the appliance, the surface it rests on or the surrounding area.

1. Remove the drip tray.
2. Remove the cup tray, empty the water and clean the drip tray with a cloth, then reassemble the drip tray.
3. Put the drip tray back in place.

### Cleaning and maintenance of the filters

About every 200 coffees or when the coffee is delivered a drop at a time of the filter holder or not at all, clean the pre-ground coffee filter holder and the filters as follows:

- Remove the filter from the filter holder.
- Rinse and clean the metal filter thoroughly in hot water using a brush. Make sure the holes in the metal filter are not blocked. If necessary, clean with a pin (see fig. 24).

Failure to clean as described above invalidates the guarantee.

### Cleaning the boiler outlet

About every 300 coffees, the boiler outlet must be cleaned as follows:

- Make sure the appliance is not hot and that it is unplugged from the mains;
- Using a screwdriver, unscrew the screw fixing the espresso boiler outlet (fig. 25);
- Remove the boiler outlet;
- Clean the boiler with a damp cloth (fig. 25);
- Clean the outlet thoroughly in hot water using a brush. Make sure the holes are not blocked. If necessary, clean with a pin.
- Rinse under running water, rubbing all the time.
- Replace the boiler outlet, making sure the gasket is correctly positioned.

Failure to clean as described above invalidates the guarantee.

### Other cleaning operations

1. Do not use solvents or abrasive detergents to clean the coffee machine. Use a soft damp cloth only.
2. Clean the filter holder cup, filters, drip tray and water tank regularly. To empty the drip tray, remove the cup tray grille, remove the water and clean the tray with a cloth: then reassemble the drip tray. Clean the water tank, using a soft brush to reach the bottom.

 **Danger!** While cleaning, never immerse the coffee maker in water. It is an electrical appliance.

## DESCALING

You are recommended to descale the coffee maker about every 200 coffees. You should use commercially available De'Longhi descaler. Proceed as follows:

1. Fill the tank with the descaler solution obtained by diluting the descaler with water following the instructions on the pack.
2. Press the ON/OFF button.
3. Make sure the filter holder is not attached and position a recipient under the cappuccino maker.
4. Wait until the OK light comes on.
5. Turn the selector to the ☐/☉ position and deliver about 1/4 of the solution in the tank: from time to time open the steam dial to discharge steam. Then interrupt delivery by turning the selector to the ⚡ position and leave the solution to work for about 5 minutes.
6. Repeat point 5 another 3 times, until the tank is empty.
7. To eliminate residues of descaler solution, rinse the tank well and fill it with clean water (without descaler).
8. Turn the selector to the ☐/☉ position and deliver water until the tank is empty.
9. Repeat points 7 and 8.

## TECHNICAL DATA

Mains voltage:	220-240V-50/60Hz
Absorbed power:	1100W
Size: LxHxD:	197x322x303 (385) mm
Pressure:	15 bar
Water tank capacity:	1 L
Power cable length:	1,40 m
Weight:	4,7 kg

 The appliance complies with the following EC directives:

- Low Voltage Directive 2006/95/EC and subsequent amendments;
- EMC Directive 2004/108/EC and subsequent amendments;
- Stand-by European Regulation 1275/2008 and subsequent amendments;
- Materials and accessories coming into contact with food conform to EEC regulation 1935/2004.



## DISPOSAL



In compliance with European directive 2002/96/EC, the appliance must not be disposed of with household waste, but taken to an authorised waste separation and recycling centre.

## TROUBLESHOOTING...

Problem	Possible causes	Solution
No espresso coffee is delivered	No water in the tank	Fill the tank with water
	The holes in the filter holder are blocked	Clean the filter holder spout holes
	The espresso boiler outlet is blocked	Clean as described in the "Cleaning" section
	Limescale in the water circuit	Descale as described in the "Descaling" section
The espresso coffee drips from the edges of the filter holder rather than the holes	The filter holder has been inserted incorrectly or is dirty	Attach the filter holder correctly and rotate firmly as far as it will go
	The espresso boiler gasket has lost elasticity or is dirty	Have the espresso boiler gasket replaced by Customer Services
	The holes in the filter holder spouts are blocked	Clean the filter holder spout holes
The espresso coffee is cold	The OK light is not on when the coffee delivery button is pressed	Wait until the OK light comes on
	No preheating was done	Pre-heat as indicated in the "Tips for a hotter coffee" section
	The cups were not preheated	Pre-heat the cups with hot water
	Limescale in the water circuit	Descale as described in the "Descaling" section

The pump is excessively noisy	The water tank is empty	Fill the tank
	The tank is not correctly in place and the valve on its base is not open	Press the tank down lightly to open the valve on the bottom
	There are air bubbles in the tank connector	Follow the instructions given in the "Hot water" section until water is delivered
The coffee froth is too dark (delivered from the spout too slowly)	The pre-ground coffee is pressed down too firmly	Press the coffee down less firmly
	There is too much pre-ground coffee	Reduce the quantity of pre-ground coffee
	The espresso boiler outlet is blocked	Clean as indicated in the "Cleaning" section
	The filter is blocked	Clean as indicated in the "Cleaning" section
	The pre-ground coffee is too fine or damp	Use only pre-ground coffee for espresso coffee makers and make sure it is not damp
	The wrong type of pre-ground coffee is being used	Use a different type of pre-ground coffee
The coffee has an acid taste	Inadequate rinsing after descaling	After descaling rinse the appliance as indicated in the "Descaling and Rinse" section
Non si forma la schiuma del No milk froth is formed when making cappuccino	Milk not cold enough	Always use semi-skimmed milk at refrigerator temperature.
	Cappuccino maker dirty	Clean the holes in the cappuccino maker thoroughly
	Limescale in the water circuit	Descal as described in the "Descaling" section
The appliance switches off	Auto-off has been triggered	Press the ON/OFF button to turn the appliance on again
The appliance switches off a few seconds after switching on	The functions selector is in the  (standby) position	Turn the functions selector to the  (standby) position, then press the ON/OFF button.