

WF0754W7(E/N/S/V/W)
WF0752W7(E/N/S/V/W)
WF0754Y7(E/N/S/V/W)
WF0752Y7(E/N/S/V/W)

Washing Machine

user manual

imagine the possibilities

Thank you for purchasing this Samsung product.
To receive a more complete service, please
register your product at

www.samsung.com/register

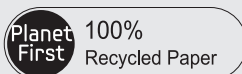

features of your new samsung washing machine

Your new washing machine will change the way you feel about doing laundry. From its specialised Eco Bubble function to its energy efficiency, your new Samsung washing machine has all the benefits to make washing laundry as easy and pleasant as possible.

- **Energy Saving**

This model offers more efficient energy use compared to standard A rated machine with the special Bubble generator system and Quiet Drive inverter motor.

- **Eco Bubble Wash**

Samsung's effective Eco Bubble delivers improved cleanliness with advanced fabric care. Eco Bubble allows detergent to distribute evenly and penetrate fabrics faster and deeper.

- **Quick Wash**

No time to waste! Quick Wash program can help your busy life - now you can wash your favorite clothes (up to 2Kg) in 15 minutes!

- **Quiet Drive Motor**

Samsung's unique Quiet Drive Motor works without belts or gears, reducing vibration and making the washer quieter and more durable.

- **Eco Drum Clean**

Using Eco Drum Clean helps to keep washing machine clean even without any chemical detergent or bleach. Keep your drum clean and odorless with specialized cleaning program.

- **Baby Care**

Your Samsung washing machine includes wash programs that add protection to the clothing of children with sensitive skin. These programs reduce skin irritation in children by minimizing detergent residue. In addition, these programs classify laundry into various types and the wash is performed according to the laundry characteristics so that children's clothes feel refreshingly clean whenever they are put on.

- **Wool Certified**

The machine has been tested and passed the required Woolmark Company specification for machine washable wool products. This mark is the upgraded certification better than the existing Woolmark, which guarantees not only washing performance but also fabric care for wool products. Fabrics should be washed according to the instructions on the garment label as specified by Woolmark and Samsung.

- **Hand Wash**

Special care can be determined by the appropriate temperature, the gentle wash action and the appropriate amount of water.

- **Delay End**

Delay a cycle for up to 19 hours in one-hour increments and increase the convenience of using your washing machine especially when you have to go out.

- **Child Lock**

The Child Lock function ensures that curious little hands are kept out of your washing machine. This safety feature stops your children from playing with the operation of the washing machine, and alerts you when it is activated.

- **Digital Graphic Display**

The Digital Graphic Display control panel is clear and easy to use for minimum fuss and hassle. And while it is easy to operate, the Digital Graphic Display enables you to make quick and accurate adjustments to your wash for excellent washing results.

- **Wide door**

Extra wide door aperture for convenient viewing! Easily add and remove laundry, especially for large sized laundry items such as bedding, towels etc.

This manual contains important information on the installation, use, and care of your new Samsung washing machine. Refer to it for descriptions of the control panel, instructions on how to use the washing machine, and tips for making the most of its state-of-the-art features and functions. The “**Troubleshooting and information codes**” section on page 37 tells you what to do if something goes wrong with your new washing machine.

safety information

Congratulations on your new Samsung washer. This manual contains important information on the installation, use and care of your appliance. Please take time to read this manual to take full advantage of your washer's many benefits and features.

WHAT YOU NEED TO KNOW ABOUT SAFETY INSTRUCTIONS













Please read this manual thoroughly to ensure that you know how to safely and efficiently operate the extensive features and functions of your new appliance and retain it at a safe place near the appliance for your future reference. Use this appliance only for its intended purpose as described in this instruction manual.

Warnings and Important Safety Instructions in this manual do not cover all possible conditions and situations that may occur. It is your responsibility to use common sense, caution, and care when installing, maintaining, and operating your washer.

Because these following operating instructions cover various models, the characteristics of your washer may differ slightly from those described in this manual and not all warning signs may be applicable. If you have any questions or concerns, contact your nearest service center or find help and information online at www.samsung.com.

IMPORTANT SAFETY SYMBOLS AND PRECAUTIONS

What the icons and signs in this user manual mean:

 WARNING	Hazards or unsafe practices that may result in severe personal injury, death and/or property damage.
 CAUTION	Hazards or unsafe practices that may result in personal injury and/or property damage.
 CAUTION	To reduce the risk of fire, explosion, electric shock, or personal injury when using your washer, follow these basic safety precautions:
 CAUTION	To reduce the risk of fire or explosion, follow these basic precautions.
	Do NOT attempt.
	Do NOT disassemble.
	Do NOT touch.
	Follow directions explicitly.
	Unplug the power plug from the wall socket.
	Make sure the machine is grounded to prevent electric shock.
	Call the service centre for help.
	Note

These warning signs are here to prevent injury to you and others.

Please follow them explicitly.

After reading this section, keep it in a safe place for future reference.

- ★ Read all instructions before using the appliance.

As with any equipment using electricity and moving parts, potential hazards exist. To safely operate this appliance, become familiar with its operation and exercise care when using it.

Do not let children (or pets) play on or in your washing machine. The washing machine door does not open easily from the inside, and children may be seriously injured if trapped inside.



This appliance is not intended for use by persons (including children) with reduced physical, sensory or mental capabilities, or lack of experience and knowledge, unless they have been given supervision or instruction concerning use of the appliance by a person responsible for their safety.

Children should be supervised to ensure that they do not play with the appliance.

If the plug (power supply cord) is damaged, it must be replaced by the manufacturer or its service agent or a similarly qualified person in order to avoid a hazard.

This appliance should be positioned to be accessible to the power plug, the water supply tabs and the drain pipes.

For washing machines with ventilation openings in the base, ensure that the opening is not obstructed by carpet or any other obstacles.

Use the new hose-sets and old hose-sets should not be reused.

safety information



SEVERE WARNING SIGNS FOR INSTALLATION

-  The installation of this appliance must be performed by a qualified technician or service company.
- Failure to do so may result in electric shock, fire, an explosion, problems with the product, or injury.

The appliance is heavy, take care upon lifting it

Plug the power cord into an AC 220-240V / 50Hz wall socket or higher and use the socket for this appliance only. In addition, do not use an extension cord.

- Sharing a wall socket with other appliances using a power strip or extending the power cord may result in electric shock or fire.
- Ensure that the power voltage, frequency and current are the same as those of the product specifications. Failure to do so may result in electric shock or fire. Plug the power plug into the wall socket firmly.

Remove all foreign substances such as dust or water from the power plug terminals and contact points using a dry cloth on a regular basis.

- Unplug the power plug and clean it with a dry cloth.
- Failure to do so may result in electric shock or fire.

Plug the power plug into the wall socket in the right direction so that the cord runs towards the floor.

- If you plug the power plug into the socket in the opposite direction, the electric wires within the cable may be damaged and this may result in electric shock or fire.

Keep all packaging materials well out of the reach of children, as packaging materials can be dangerous to children.

- If a child places a bag over its head, it may result in suffocation.

When the appliance or power plug or power cord is damaged, contact your nearest service centre.

-
-  This appliance must be properly grounded.
Do not ground the appliance to a gas pipe, plastic water pipe, or telephone line.
- This may result in electric shock, fire, an explosion, or problems with the product
 - Never plug the power cord into a socket that is not grounded correctly and make sure that it is in accordance with local and national codes.

-
-  Do not install this appliance near a heater, inflammable material.
Do not install this appliance in a humid, oily or dusty location, in a location exposed to direct sunlight and water (rain drops).

Do not install this appliance in a location of low temperature

- Frost may cause tubes to burst

Do not install this appliance in a location where gas may leak.

- This may result in electric shock or fire.

Do not use an electric transformer.

- It may result in electric shock or fire.

Do not use a damaged power plug, damaged power cord or loose wall socket.

- This may result in electric shock or fire.

Do not pull or excessively bend the power cord.

Do not twist or tie the power cord.

Do not hook the power cord over a metal object, place a heavy object on the power cord, insert the power cord between objects, or push the power cord into the space behind the appliance.

- This may result in electric shock or fire.

Do not pull the power cord, when unplugging the power plug.

- Unplug the power plug by holding the plug.
- Failure to do so may result in electric shock or fire.

Do not lay the power cord and tubes where you may fall over them.



CAUTION SIGNS FOR INSTALLATION



- This appliance should be positioned in such a way that it is accessible to the power plug.
 - Failure to do so may result in electric shock or fire due to electric leakage.

Install your appliance on a level and hard floor that can support its weight.

- Failure to do so may result in abnormal vibrations, moves, noise, or problems with the product.



SEVERE WARNING SIGNS FOR USING



- If the appliance is flooded, Turn off the water & power supply immediately and contact your nearest service centre.

- Do not Touch the power plug with wet hands
- Failure to do so may cause electric shock

If the appliance generates a strange noise, a burning smell or smoke, unplug the power plug immediately and contact your nearest service centre.

- Failure to do so may result in electric shock or fire.

In the event of a gas leak (such as propane gas, LP gas, etc.), ventilate immediately without touching the power plug. Do not touch the appliance or power cord.

- Do not use a ventilating fan.
- A spark may result in an explosion or fire.

Do not let children play in or on the washer. In addition, when disposing of the appliance, remove the washer door lever.

- If trapped inside, the child may become trapped and suffocate to death.

Make sure to remove the packaging (sponge, styrofoam) attached to the bottom of the washer before using it.

safety information

-  Do not wash items contaminated with gasoline, kerosene, benzene, paint thinner, alcohol or other flammable or explosive substances.

- This may result in electric shock, fire or an explosion.

Do not open the washer door by force while it is operating (high-temperature washing/drying/spinning).

- Water flowing out of the washer may result in burns or cause the floor to be slippery.

This may result in injury.

- Opening the door by force may result in damage to the product or injury.

Do not insert your hand under the washer.

- This may result in injury.

Do not touch the power plug with wet hands.

- This may result in electric shock.

Do not turn the appliance off by unplugging the power plug while an operation is in progress.

- Plugging the power plug into the wall socket again may cause a spark and result in electric shock or fire.

Do not let children or infirm persons use this washer unsupervised. Do not let children climb in the appliance

- Failure to do so may result in electric shock, burns or injury.

Do not insert your hand or a metal object under the washer while it is operating.

- This may result in injury.

Do not unplug the appliance by pulling at the power cord, always grip plug firmly and pull straight out from the outlet.

- Damage to the cord may cause short-circuit, fire and/or electric shock

-  Do not attempt to repair, disassemble, or modify the appliance yourself.

- Do not use any fuse (such as cooper, steel wire, etc.) other than the standard fuse.

- When repairing or reinstalling the appliance is required, contact your nearest service centre.

- Failure to do so may result in electric shock, fire, problems with the product, or injury.

-  If the water supply hose comes loose from the Water tap and floods the appliance, unplug the power plug.

- Failure to do so may result in electric shock or fire.

Unplug the power plug when the appliance is not being used for long periods of time or during a thunder/lightning storm.

- Failure to do so may result in electric shock or fire.



CAUTION SIGNS FOR USING



When the washer is contaminated by a foreign substance such as detergent, dirt, food waste, etc., unplug the power plug and clean the washer using a damp and soft cloth.

- Failure to do so may result in discolouration, deformation, damage or rust.

The front glass may be broken by a strong impact. Take care when using the washer.

- When the glass is broken, it may result in injury.

After a water supply failure or when reconnecting the water supply hose, open the Water Tap slowly.

Open the Water Tap slowly after a long period of non-use.

- The air pressure in the water supply hose or the water pipe may result in damage to a part or in water leakage.

If a drain error occurs during an operation, check if there is a draining problem.

- If the washer is used when it is flooded because of a draining problem, it may result in electric shock or fire due to electric leakage.

Insert the laundry into the washer completely so that laundry does not get caught in the door.

- If laundry gets caught in the door, it may result in damage to the laundry or the washer, or result in water leakage.

Ensure that the Water Tap is turned off when the washer is not being used.

- Ensure that the screw on the water supply hose connector is properly tightened.
- Failure to do so may result in property damage or injury.

Check if the rubber seal is not contaminated by foreign substances (waste, thread, etc).

- If the door is not closed completely, it may result in water leakage.

Open the Water Tap and check if the water supply hose connector is firmly tightened and that there is no water leaking before using the product.

- If the screws or the water supply hose connector are loose, it may result in water leakage.

safety information

-  Do not stand on top of the appliance or place objects (such as laundry, lighted candles, lighted cigarettes, dishes, chemicals, metal objects, etc.) on the appliance.
- This may result in electric shock, fire, problems with the product, or injury.

Do not spray volatile material such as insecticide onto the surface of the appliance.

- As well as being harmful to humans, it may also result in electric shock, fire or problems with the product.

Do not place an object that generates a electromagnetic field near the washer.

- This may result in injury due to a malfunction.

Since the water drained during a high-temperature wash or drying cycle is hot, do not touch the water.

- This may result in burns or injury.

Do not wash, spin or dry water-proof seats, mats or clothing (*) unless your appliance has a special program for washing these items.

- Do not wash thick, hard mats even if the washer mark is on the care label.
- This may result in injury or damage to the washer, walls, floor or clothing due to abnormal vibrations.

* Woollen bedding, rain covers, fishing vests, ski pants, sleeping bags, diaper covers, sweat suits, and bicycle, motor cycle, car covers, etc.

Do not operate the washer when the detergent box is removed.

- This may result in electric shock or injury due to water leakage.

Do not touch the inside of the tub during or just after drying as it is hot.

- This may result in burns.

Do not insert your hand into the detergent box after opening it.

- This may result in injury as your hand may be caught by the detergent input device. Do not place any objects (such as shoes, food waste, animals) other than laundry into the washer.
- This may result in damage to the washer, or injury and death in the case of pets due to the abnormal vibrations.

Do not press the buttons using sharp objects such as pins, knives, fingernails, etc.

- This may result in electric shock or injury.

Do not wash laundry contaminated by oils, creams or lotions usually found in skincare shops or massage clinics.

- This may result in the rubber seal becoming deformed and water leakage.

Do not leave metal objects such as a safety pin or hair pin, or bleach in the tub for long periods of time.

- This may cause the tub to rust.
- If rust starts appearing on the surface of the tub, apply a cleansing agent (neutral) to the surface and use a sponge to clean it. Never use a metal brush.

Do not use dry cleaning detergent directly and do not wash, rinse, or spin laundry contaminated by dry cleaning detergent.

- This may result in spontaneous combustion or ignition due to the heat of the oxidation of the oil.

Do not use hot water from water cooling/heating devices.

- This may result in problems with the washer.

Do not use natural hand-washing soap for the washer.

- If it hardens and accumulates inside the washer, it may result in problems with the product, discolouration, rust or bad odors.

Do not wash large laundry items such as bedding in the washing net.

- Place socks and brassieres into the washing net and wash them with the other laundry.
- Failure to do so may result in injury due to abnormal vibrations.

Do not use hardened detergent.

- If it accumulates inside the washer, it may result in water leakage.

For washing machines with ventilation openings in the base, ensure that the opening is not obstructed by carpet or any other obstacles.

Make sure that the pockets of all clothing to be washed are empty.

- Hard, sharp objects, such as coins, safety pins, nails, screws, or stones can cause extensive damage to the appliance.

Do not wash clothing with large buckles, buttons, or other heavy metal.



SEVERE WARNING SIGNS FOR CLEANING



Do not clean the appliance by spraying water directly onto it.

Do not use benzene, thinner or alcohol to clean the appliance.

- This may result in discolouration, deformation, damage, electric shock or fire.

Before cleaning or performing maintenance, unplug the appliance from the wall socket.

- Failure to do so may result in electric shock or fire.

contents

SETTING UP YOUR WASHING MACHINE

13

- 13 Checking the parts
- 14 Meeting installation requirements
 - 14 Electrical supply and grounding
 - 14 Water Supply
 - 15 Drain
 - 15 Flooring
 - 15 Surrounding temperature
 - 15 Alcove or closet installation
- 15 Installing your washing machine
- 20 Environment

WASHING A LOAD OF LAUNDRY

21

- 21 Washing for the first time
- 21 Basic instructions
- 22 Using the control panel
 - 25 Child lock
 - 25 Sound off
 - 26 Delay end
 - 26 My cycle
 - 27 Eco Bubble
 - 28 Washing clothes using the cycle selector
 - 29 Washing clothes manually

- 29 Laundry guidelines
- 30 Detergent and additives information
 - 30 Which detergent to use
 - 31 Detergent drawer
 - 31 Liquid Detergent (Selected models)
- 32 Hygiene Drum Clean
- 33 Draining the washing machine in an emergency
- 34 Cleaning the debris filter
- 34 Cleaning the exterior
- 35 Cleaning the detergent drawer and drawer recess
- 35 Cleaning the water hose mesh filter
- 36 Repairing a frozen washing machine
- 36 Storing your washing machine
- 37 Check these points if your washing machine...
- 38 Information codes

CLEANING AND MAINTAINING YOUR WASHING MACHINE

32

TROUBLESHOOTING AND INFORMATION CODES

37

CYCLE CHART

39

APPENDIX

40

- 39 Cycle chart
- 40 Fabric care chart
- 40 Protecting the environment
- 40 Declaration of conformity
- 41 Specifications

setting up your washing machine

Be sure to have your installer follow these instructions closely so that your new washing machine works properly and so that you're not at risk of injury when doing laundry.

CHECKING THE PARTS

Carefully unpack your washing machine, and make sure you've received all of the parts shown below. If your washing machine was damaged during shipping, or if you do not have all of the parts, contact Samsung Customer Service or your Samsung dealer.

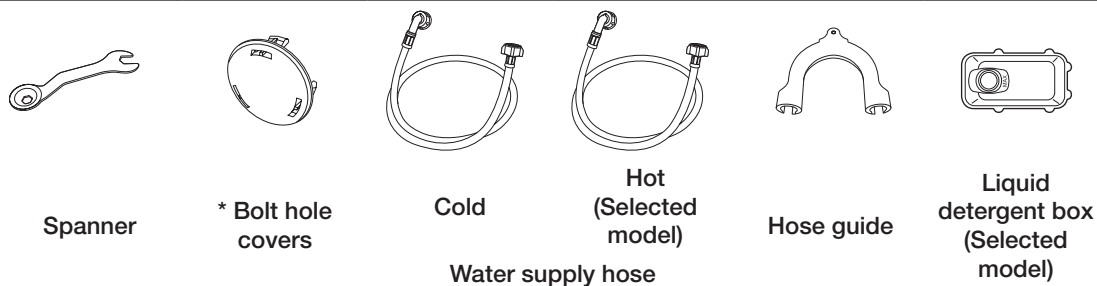
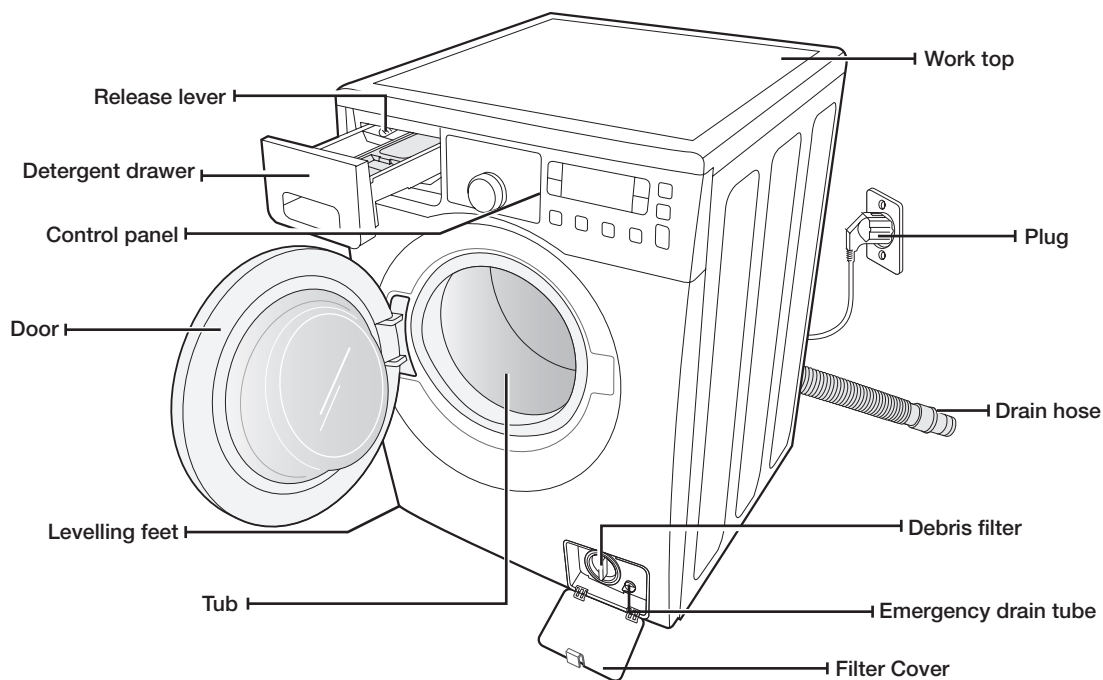

* Bolt hole covers : The number of bolt hole covers depends on the model (3~5 covers).

setting up your washing machine

MEETING INSTALLATION REQUIREMENTS

Electrical supply and grounding



Never use an extension cord.
Use only the power cord that comes with your washing machine.

When preparing for installation, ensure that your power supply offers:

- AC 220-240V / 50Hz fuse or circuit breaker
- Individual branch circuit serving only your washing machine

Your washing machine must be grounded. If your washing machine malfunctions or breaks down, grounding will reduce the risk of electric shock by providing a path of least resistance for the electric current.

Your washing machine comes with a power cord having a three-prong grounding plug for use in a properly installed and grounded outlet.



Never connect the ground wire to plastic plumbing lines, gas lines, or hot water pipes.

Improperly connecting the equipment-grounding conductor can result in electric shock. Check with a qualified electrician or serviceman if you are unsure if the washing machine is properly grounded. Do not modify the plug provided with the washing machine. If it does not fit the outlet, have a proper outlet installed by a qualified electrician.

Water Supply

Your washing machine will fill properly when your water pressure is 50 kPa ~ 800 kPa. Water pressure less than 50 kPa may cause water valve failure, not allowing the water valve to shut off completely. Or, it may take the washing machine longer to fill than what the controls allow, resulting in your washing machine turning off. (A fill-time limit, designed to prevent overflows/flooding if an internal hose becomes loose, is built into the controls.)

The water taps must be within 120cm of the back of your washing machine for the provided inlet hoses provided to reach your washing machine.



Most plumbing supply stores sell inlet hoses of various lengths up to 305 cm long.

You can reduce the risk of leaks and water damage by:

- Making water taps easily accessible.
- Turning off taps when the washing machine is not in use.
- Periodically checking for leaks at water inlet hose fittings.



Before using your washing machine for the first time, check all connections at the water valve and taps for leaks.

Drain

Samsung recommends a standpipe height of 65cm. The drain hose must be routed through the drain hose clip to the standpipe. The standpipe must be large enough to accept the outside diameter of the drain hose. The drain hose is attached at the factory.

Flooring

For best performance, your washing machine must be installed on a solidly constructed floor. Wood floors may need to be reinforced to minimize vibration and/or unbalanced loads. Carpeting and soft tile surfaces are contributing factors to vibrations and the tendency for your washing machine to move slightly during the spin cycle.

Never install your washing machine on a platform or poorly supported structure.

Surrounding temperature

Do not install your washing machine in areas where water may freeze, since your washing machine always retains some water in its water valve, pump, and hose areas. Frozen water in the lines can cause damage to belts, the pump, and other components.

Alcove or closet installation

To operate safely and properly, your new washing machine requires minimum clearances of:

Sides – 25 mm

Rear – 50 mm

Top – 25 mm

Front – 465 mm

If both the washing machine and a dryer are installed together, the front of the alcove or closet must have at least 465 mm unobstructed air opening. Your washing machine alone does not require a specific air opening.

INSTALLING YOUR WASHING MACHINE

STEP 1

Selecting a location



Before you install the washing machine, make sure the location:

- Has a hard, level surface without carpeting or flooring that may obstruct ventilation
- Is away from direct sunlight
- Has adequate ventilation
- Will not be freezing (below 0 °C)
- Is away from heat sources such as oil or gas
- Has enough space so that the washing machine doesn't stand on its power cord

setting up your washing machine

STEP 2

Removing the shipping bolts

Before installing the washing machine, you must remove all shipping bolts from the back of the unit.

1. Loosen all the bolts with the supplied wrench.

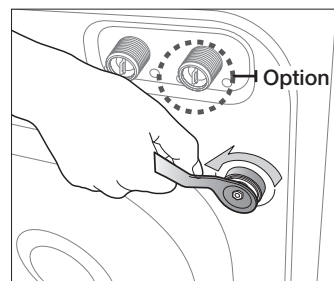

2. Hold the bolt with the spanner and pull it through the wide section of the hole. Repeat for each bolt.

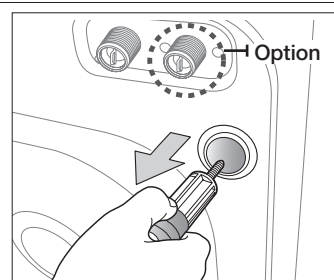

3. Fill the holes with the supplied plastic covers.

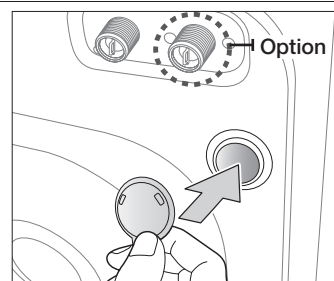

4. Store the shipping bolts away safely in case you have to move the washing machine in the future.



WARNING Packaging materials can be dangerous to children; keep all packaging material (plastic bags, polystyrene, etc.) well out of the reach of children.

STEP 3 Adjusting the Levelling feet

 When installing your washing machine, ensure that the power plug, the water supply and the drain are easily accessible.

1. Slide the washing machine into position.

2. Level your washing machine by turning the levelling feet in and out as necessary by hand.

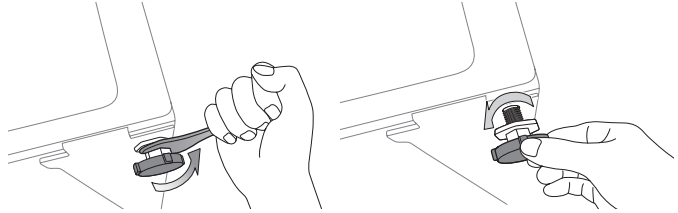

3. When your washing machine is level, tighten the nuts using the wrench supplied with your washing machine.

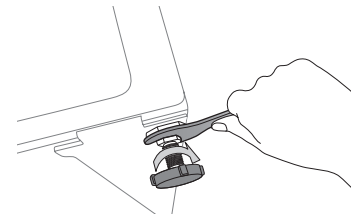

STEP 4 Connecting the water and drain

Connecting the water supply hose

1. Take the L-shaped arm fitting for the cold water supply hose and connect it to the cold water supply intake on the back of the machine. Tighten by hand.

 The water supply hose must be connected to the washing machine at one end and to the water tap at the other. Do not stretch the water supply hose. If the hose is too short, replace the hose with a longer, high pressure hose.

2. Connect the other end of the cold water supply hose to your sink's cold water tap and tighten it by hand. If necessary, you can reposition the water supply hose at the washing machine end by loosening the fitting, rotating the hose, and retightening the fitting.

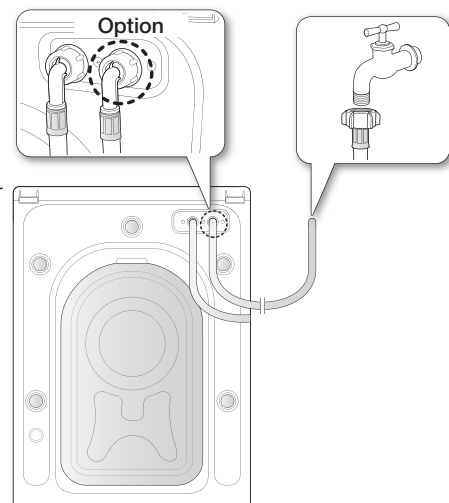

For selected models with an additional hot water intake:

1. Take the red L-shaped arm fitting for the hot water supply hose and connect it to the hot water supply intake on the back of the machine. Tighten by hand.

2. Connect the other end of the hot water supply hose to your sink's hot water tap and tighten it by hand.

3. Use a Y-piece if you only want to use cold water.

setting up your washing machine

Connecting the water supply hose

1. Remove the adaptor from the water supply hose.

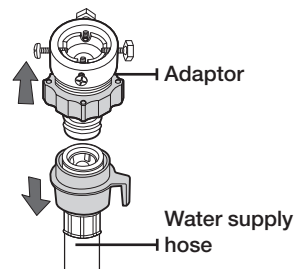

2. First, using a '+' type screwdriver, loosen the four screws on the adaptor. Next, take the adaptor and turn part (2) following the arrow until there is a 5 mm gap.

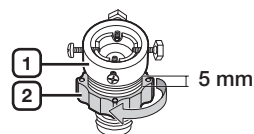

3. Connect the adaptor to the water tap by tightening the screws firmly while lifting the adaptor upwards. Turn part (2) following the arrow and connect (1) and (2).

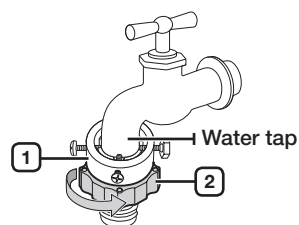

4. Connect the water supply hose to the adaptor. When you release part (3), the hose automatically connects to the adaptor making a 'click' sound.

After you have connected the water supply hose to the adaptor, ensure that it is connected correctly by pulling the water supply hose downwards.

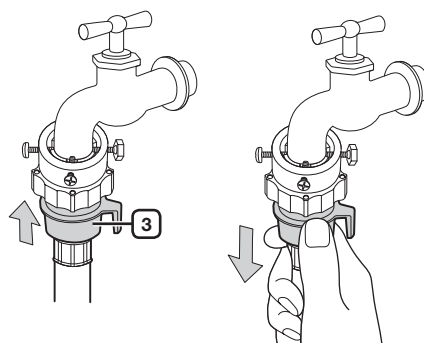

5. Connect the other end of the water supply hose to the inlet water valve at the rear of the washing machine. Screw the hose clockwise all the way in.

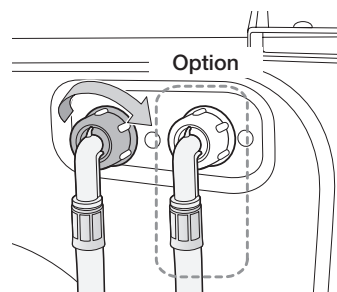

6. Turn on the water supply and ensure that no water leaks from the water valve, tap or adaptor. If there is a water leak, repeat the previous steps.



Do not use your washing machine if there is a water leak. This may cause electric shock or injury.

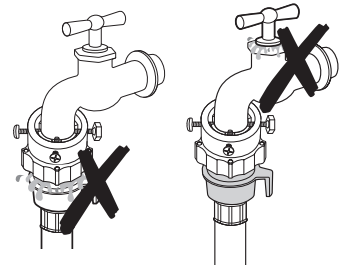

- If the water tap has a screw type tap, connect the water supply hose to the tap as shown.

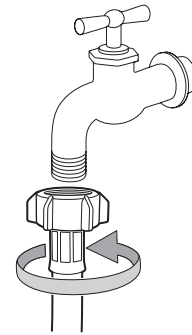

Use the most conventional type of tap for the water supply. In case the tap is square or too big, remove the spacing ring before inserting the tap into the adaptor.

Connecting the Aqua Hose (Selected models)

The Aqua Hose was invented for perfect leakage protection. It is attached to the water supply hose and automatically cuts off the water flow if the hose is damaged. It also displays a warning indicator.

- Connect the water supply hose to the tap as shown.

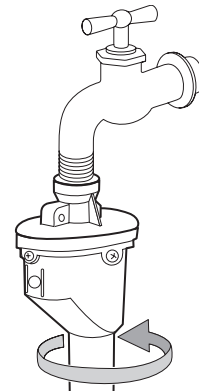

setting up your washing machine

Connecting the drain hose

The end of the drain hose can be positioned in three ways:

1. **Over the edge of a wash basin:** The drain hose must be placed at a height of between 60 and 90 cm. To keep the drain hose spout bent, use the supplied plastic hose guide. Secure the guide to the wall with a hook or to the tap with a piece of string to prevent the drain hose from moving.

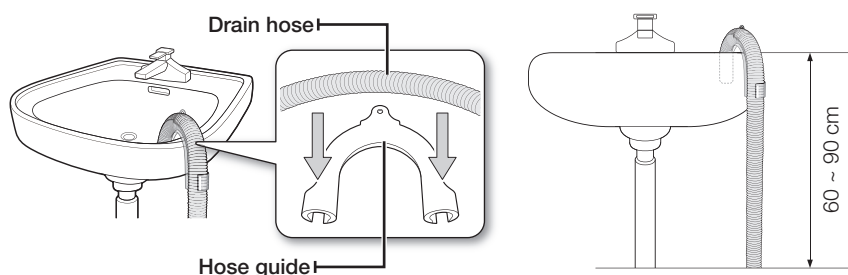

2. **In a sink drain pipe branch:** The drain pipe branch must be above the sink siphon so that the end of the hose is at least 60 cm above the ground.
3. **In a drain pipe:** We recommend using a 65 cm high vertical pipe; it must be no shorter than 60 cm and no longer than 90 cm.

-  The standpipe drain requires;
- minimum diameter 5 cm.
 - minimum carry-away capacity 60 liter per minute.

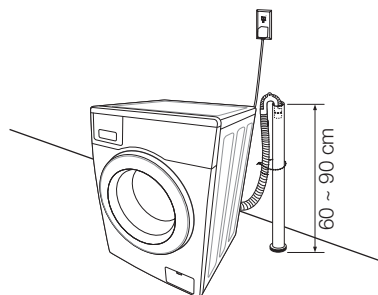

STEP 5

Powering your washing machine

Plug the power cord into a wall sockets, an AC 220-240V / 50Hz approved electrical outlet protected by a fuse or circuit breaker. (For more information on electrical and grounding requirements, see page 14.)

ENVIRONMENT

Please dispose of the packaging materials for this product in an “environmentally friendly” manner. For further detail, please contact your local area authority.

washing a load of laundry

With your new Samsung washing machine, the hardest part of doing laundry will be deciding which load to wash first.

WASHING FOR THE FIRST TIME

 Before washing laundry for the first time, you must run a complete empty cycle (i.e. no laundry).

1. Press the **Power** button.
2. Add a little detergent to the detergent compartment ② in the detergent drawer.
3. Turn on the water supply to the washing machine.
4. Press the **Start/Pause** button.

 This will remove any water that might be left over in the machine from the manufacturer's test run.

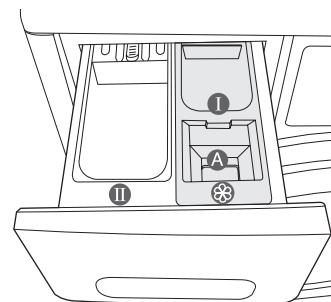

Compartment ①: Detergent for prewash, or starch.

Compartment ②: Detergent for the main wash, water softener, pre-soaking agent, bleach and stain removal product.

 To use liquid detergent, use the liquid detergent box (refer to page 31 of the manual for the corresponding model). Do not add powdered detergent into the liquid detergent box.

Compartment Ⓜ: Additives, e.g. fabric softener or former (fill no higher than lower edge (MAX) of "A")

BASIC INSTRUCTIONS

1. Load your laundry into the washing machine.

 **WARNING** Do not overload the washing machine. To determine the load capacity for each type of laundry, refer to the chart on page 30.

-  • Make sure that laundry is not caught in the door, as this may cause a water leak.
- Washing detergent may remain in the front rubber part of the washer after a wash cycle. Remove any remaining detergent, as they may cause a water leak.
- Do not touch the door glass while your washing machine is running or it may be hot.
- Do not open the detergent drawer or the debris filter while your washing machine is running or you might be exposed to hot water or steam.
- Do not wash water-proofed items in normal cycle except outdoor care program.

2. Close the door until it latches.
3. Turn the power on.
4. Add detergent and additives to the dispenser drawer.
5. Select the appropriate cycle and options for the load.
The Wash Indicator light will illuminate and the estimated cycle time will appear in the display.
6. Press the **Start/Pause** button.

washing a load of laundry

USING THE CONTROL PANEL

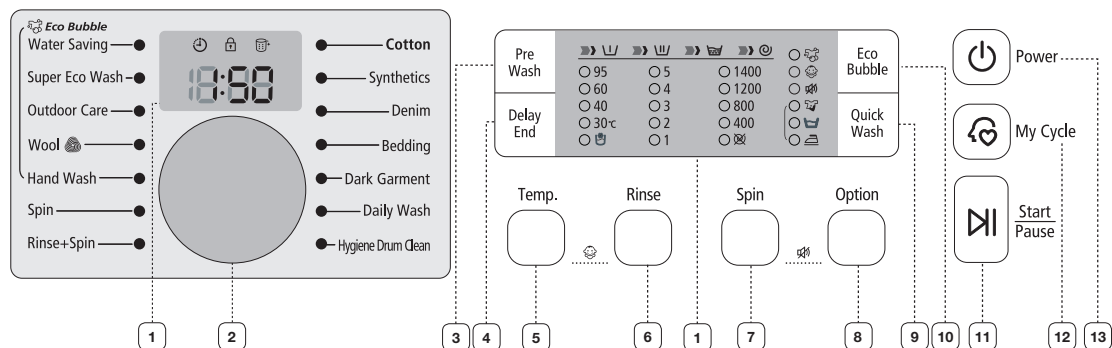

1 DIGITAL GRAPHIC DISPLAY

Displays the remaining wash cycle time, all cycle information, and error messages.

2 CYCLE SELECTOR

Select the tumble pattern and spin speed for the cycle.

For detailed information, refer to “Washing clothes using the cycle selector”. (see page 28)

Cotton - For average or lightly soiled cottons, bed linen, table linen, underwear, towels, shirts, etc.

Synthetics - For averagely or lightly soiled blouses, shirts, etc., made of polyester (diolen, trevira), polyamide (perlon, nylon) or other similar blends.

Denim - A higher water level in the main wash and extra rinse ensure that no washing powder remains that may mark your clothing.

Bedding - For bed spread, bed sheet, duvet cover etc.

Wash under 1.8kg and only 1 kind of bedding to achieve the best result.

Dark Garment - Additional rinses and reduced spinning ensure that your favourite dark clothes are washed gently and rinsed thoroughly.

Daily Wash - Use for everyday items such as underwear and shirts.

Hygiene Drum Clean - Use for drum cleaning. It cleanses dirt and bacteria of drum. Regular use (after every 40 washes) is recommended. No detergent or bleach needed.

Water Saving - This is a specially designed course that enables you to wash laundry effectively with the minimum amount of water. Water saving, 40 °C water temperature, 3 rinses, Intensive wash, 1400 rpm spin is suitable for a normally soiled cotton load.

Super Eco Wash - Low temperature Eco Bubble ensures that you achieve perfect wash results while allowing effective energy saving.

Outdoor Care - Use for outdoor wear such as mountain clothes, skiwear, and sports wear. Fabrics include functional technology finishes and fibers such as spandex, stretch, and micro-fiber.

Wool - Only for machine-washable wool. A load should be less than 2.0 kg.

- The wool course washes the laundry using gentle cradling actions. During the wash, the gentle cradling and soaking actions are continued to protect the wool fibers from shrinkage / distortion and for a super gentle clean. This stop operation is not a problem.
- Neutral detergent is recommended for wool course, for improved washing results and for improved care of the wool fibers.



The wool wash cycle of this machine has been approved by Woolmark for the washing of machine-washable Woolmark products provided that the products are washed according to the instructions on the garment label and those issued by the manufacturer of this washing machine, M1001 (Certificate Number issued by I.W.S. Nominee Co., Ltd.)

Hand Wash - A very light wash cycle as gentle as a hand wash.

Spin - Performs an additional spin cycle to remove more water.

Rinse + Spin - Use for a load that needs rinsing only or to add rinse-added fabric softener to a load.

3 PREWASH SELECTION BUTTON Press this button to select pre-wash. Pre-wash is only available with: Cotton, Synthetics, Denim, Bedding, Dark Garment, Daily Wash, Water Saving.

4 DELAY END SELECTION BUTTON Press this button repeatedly to cycle through the available Delay End options (from 3 hours to 19 hours in one hour increments). The hour displayed indicates the time when the wash cycle will be finished.

5 TEMPERATURE SELECTION BUTTON Press this button repeatedly to cycle through the available water temperature options: (Cold Water , 30 °C, 40 °C, 60 °C and 95 °C).

6 RINSE SELECTION BUTTON Press this button to add additional rinse cycles. The maximum number of rinse cycles is five.

7 SPIN SELECTION BUTTON Press the button repeatedly to cycle through the available speeds for the spin cycle.

WF0754	 , 400, 800, 1200, 1400 rpm
WF0752	 , 400, 800, 1000, 1200 rpm

“No spin ” - The laundry remains in the drum and no spin cycle is performed after the final drain.

8 OPTION SELECTION BUTTON Press this button repeatedly to cycle through the options: Easy Iron → Soak → Intensive → Easy Iron + Soak → Easy Iron + Intensive → Soak + Intensive → Easy Iron + Intensive + Soak → off
“Easy Iron”: Use this option to prepare your laundry so that it can be easily ironed.

“Soak”: Use this option to effectively remove stains from your laundry by soaking your laundry.

- The Soak function is performed 13 minutes into the wash cycle.
- The Soak function continues for 30 minutes with six cycles, where one cycle is a soak cycle that spins for 1 minute and stands still for 4 minutes.
- The Soak function is only available for the following wash programs: Cotton, Synthetics, Denim, Bedding, Daily Wash, Water Saving.

“Intensive”: Press this button when the laundry is heavily soiled and needs to be washed intensively. The cycle time is increased for each cycle.

washing a load of laundry

9 QUICK WASH SELECTION BUTTON	<p>For lightly soiled garments and less than 2kg laundry that you require quickly. It takes about minimum 15 minute, but can vary from the indicated values depending on water pressure, water hardness, water inlet temperature, room temperature, type and amount of washing and degree of soiling, utilized detergent unbalanced load, fluctuation in the electricity supply and extra options selected.</p> <ul style="list-style-type: none">• Press this button repeatedly to choose cycle time: 15min → 20min → 30min → 40min → 50min → 60min → Off <p> WARNING Powdered/Liquid detergent should be under 20g(for 2kg load) or detergent may remain on the clothes.</p>
10 ECO BUBBLE SELECTION BUTTON	<p>Eco Bubble selection is turned on as a default. Press the Eco Bubble option button once to deselect and the Bubble Generator OFF (shown on the panel), press it again to turn the function back ON.</p> <ul style="list-style-type: none">• Some wash cycles must have Eco Bubble option ON (will show on the panel, and the Generator will turn on automatically).• Other wash cycles do not need this option and automatically turn the Generator OFF.• On many cycles, you can manually adjust this option, which will visibly affect wash time on the panel to achieve results (please see page 27 for more information).
11 START/PAUSE SELECTION BUTTON	<p>Press to pause and restart a cycle.</p>
12 MY CYCLE SELECTION BUTTON	<p>Choose your favorite cycle including temperature, spin, soil level, option, etc.</p>
13 POWER BUTTON	<p>Press it once to turn your washing machine on, press it again to turn your washing machine off. If the washing machine is left on for more than 10 minutes without any buttons being touched, the power automatically turns off.</p>

Child lock

The Child Lock function allows you to lock the buttons so that the wash cycle you've chosen can't be changed.

Activating/Deactivating

If you want to activate or deactivate the Child Lock function, press the **Temp.** and **Rinse** buttons at the same time for 3 seconds. "Child Lock" will be lit when this feature is activated.

 When the Child Lock function is activated, only the **Power** button works. The Child Lock function remains on even after the power is turned on and off or after the disconnecting and reconnecting the power cord.

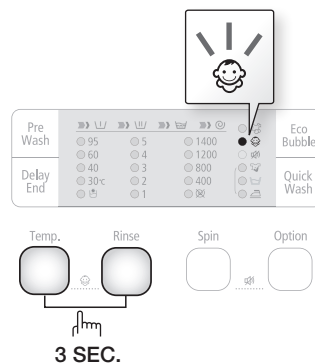

Sound off

The Sound Off function can be selected during all courses. When this function is selected, sound is turned off for all courses. Even if the power is turned on and off repeatedly, the setting is retained.

Activating/Deactivating

If you want to activate or deactivate the Sound Off function, press the **Spin** and **Option** buttons at the same time for 3 seconds. The "Sound Off" will be lit when this feature is activated.

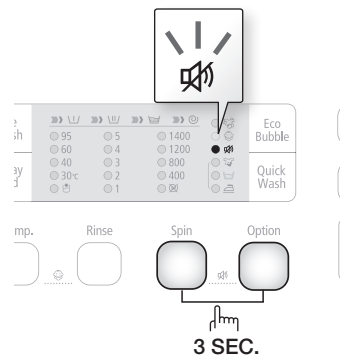

washing a load of laundry

Delay end

You can set the washing machine to finish your wash automatically at a later time, choosing a delay of between 3 to 19 hours (in 1 hour increments). The hour displayed indicates the time at which the wash will be finished.

1. Manually or automatically set your washing machine according to the type of laundry you are washing.
2. Press the **Delay End** button repeatedly until the delay time is set.
3. Press the **Start/Pause** button. The “Delay End ⌚” indicator will be lit, and the clock will begin counting down until it reaches the set time.
4. To cancel a Delay End function, press the **Power** button and then turn the washing machine on again.

My cycle

Allows you to activate your custom wash (temperature, spin, soil level, etc.) with one button convenience.

By pushing the **My Cycle** button, press the My Cycle button to load and use the saved My Cycle options. The chosen course and option lights will flicker.

You can set all options as follows in the My Cycle mode.

1. Turn the water supply on.
2. Press the **Power** button.
3. Select cycle using the **Cycle Selector**.
4. After cycle selection, set each option.



See the “Cycle Chart” on page 39 for available option settings with each cycle.

5. You can then store the selected cycle and options by pressing and holding the **My Cycle** button for longer than 3 seconds in My Cycle mode. The cycle and options you select will be displayed the next time you choose the My Cycle function.



You can change the My Cycle settings by repeating the same process above. The last used setting will be displayed the next time you choose the My Cycle function.



If you press My Cycle and release it within 3 seconds, the previously saved course and options appear. If you press and hold My Cycle for 3 second or longer, the currently set course and options are saved and the LED blinks for 3 seconds.

Eco Bubble

Eco Bubble allows detergent to distribute evenly and penetrate fabrics faster and deeper.

- The bubble function is available in all courses except for Hygiene Drum Clean course and the function availability is as follows.

Course	Bubble function	Canceling the bubble function
Cotton, Synthetics, Denim, Bedding, Dark Garment, Daily Wash	Available	Available
Water Saving, Super Eco Wash, Outdoor Care, Wool, Hand Wash		Not available
Hygiene Drum Clean	Not available	-

- A different bubble function may be applied depending the course.

- Eco Bubble selection is default. Press it once to deselect bubble option, press it again to select bubble option.

- Open the door, place the laundry inside the wash tub and close the door.
- Press the **Power** button.
- Select a function.

- Place the appropriate amount of detergent and fabric softener into the corresponding compartments depending on the amount of laundry and close the detergent drawer.
 - Add the appropriate amount of detergent into the detergent compartment ①, and add the fabric softener to softener compartment ② just under the fiber softener base line (MAX) of "A"
 - When the Prewash course is selected, add detergent into the prewash compartment ③ as well.
 - To use liquid detergent, leave the liquid detergent box in the drawer (refer to "Liquid Detergent" section on page 31).

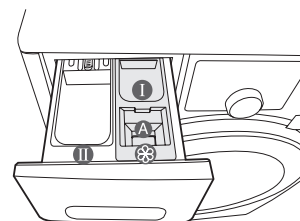

- Do not add powdered detergent into the liquid detergent box.

- Press the Start/Pause button.
 - Press the **Start/Pause** button to start the wash.
 - The amount of the laundry is automatically detected and the laundry is washed.
 - Once a washing machine operation begins, you cannot add or select the bubble function.

- Enough bubbles are generated with the specified amount of detergent.
- Please clean the Debris filter frequently. Periodic cleaning helps generate sufficient bubbles.
 - Depending on the detergent and the laundry, the bubbles may be absorbed and seem like a small quantity.
 - Although bubbles are generated once the wash begins, it may take several minutes for users to see them.

washing a load of laundry

Washing clothes using the cycle selector

Your new washing machine makes washing clothes easy, using Samsung's "Fuzzy Control" automatic control system. When you select a wash program, the machine will set the correct temperature, washing time, and washing speed.

1. Turn on your sink's water tap.
 2. Press the **Power** button.
 3. Open the door.
 4. Load the articles one at a time loosely into the drum, without overfilling it.
 5. Close the door.
 6. Add detergent, softener, and pre-wash detergent (if necessary) into the appropriate compartments.
-  Pre-wash is only available when selecting the Cotton, Synthetics, Denim, Bedding, Dark Garment, Daily Wash, Water Saving cycles. It is only necessary if your clothing is heavily soiled.
7. Use the **Cycle Selector** to select the appropriate cycle according to the type of material: Cotton, Synthetics, Denim, Bedding, Dark Garment, Daily Wash, Water Saving, Super Eco Wash, Outdoor Care, Wool, Hand Wash. The relevant indicators will illuminate on the control panel.
 8. At this time, you can control the wash temperature, the amount of rinses, the spinning speed, and the delay time by pressing the appropriate option button.
 9. Press the **Start/Pause** button and the wash will begin. The process indicator will light up and the remaining time for the cycle will appear in the display.

Pause Option

Within 5 minutes of starting a wash, it is possible to add/remove laundry items.

1. Press the **Start/Pause** button to unlock the door.
-  The door cannot be opened when the water is too HOT or the water level is too HIGH.
2. After closing the door, press the **Start/Pause** button to restart the wash.

When the cycle is finished:

After the total cycle has finished, the power will turn off automatically.

1. Open the door.
2. Remove laundry.

Washing clothes manually

You can wash clothes manually without using the Cycle Selector.

1. Turn the water supply on.
2. Press the **Power** button on the washing machine.
3. Open the door.
4. Load the articles loosely into the drum one at a time, without overfilling it.
5. Close the door.
6. Add detergent and, if necessary, softener or prewash detergent, into the appropriate compartments.
7. Press the **Temp.** button to select the temperature. (Cold water, 30 °C, 40 °C, 60 °C, 95 °C)
8. Press the **Rinse** button to select the required number of rinse cycles.
The maximum number of rinse cycles is five.
The wash duration is increased accordingly.
9. Press the **Spin** button to select the spin speed. (⊗ : No Spin)
10. Press the **Delay End** button repeatedly to cycle through the available Delay End options (from 3 hour to 19 hours in one hour increments). The hour displayed indicates the time at which the wash will be finished.
11. Press the **Start/Pause** button and the machine will begin the cycle.

LAUNDRY GUIDELINES

Follow these simple guidelines for the cleanest laundry and the most efficient wash.

 Always check the Care label on clothing before washing.

Sort and wash your laundry according to the following criteria:

- Care Label: Sort laundry into cottons, mixed fibres, synthetics, silks, wools and rayons.
- Colour: Divide whites and colours. Wash new colour items separately.
- Size: Placing items of different sizes in the same load will improve the wash action.
- Sensitivity: Wash delicate items separately, using the Delicate wash cycle for pure, new woollen items, curtains and silk articles. Check the labels on the items you are washing or refer to the fabric care chart in the appendix.

Emptying pockets

Before each wash, empty all the pockets of your laundry. Small, irregularly shaped hard objects, such as coins, knives, pins, and paperclips could damage your washing machine. Do not wash clothing with large buckles, buttons, or other heavy metal objects.

Metal on clothing may damage your clothing as well as the tub. Turn clothing with buttons and embroidered clothes inside out before washing them. If zips of pants and jackets are open while washing, the spin basket may be damaged. Zips should be closed and fixed with a string before washing.

Clothing with long strings may become entangled with other clothes damaging them. Be sure to fix the strings before starting the wash.

Prewashing cotton

Your new washing machine, combined with modern detergents, will give perfect washing results, thus saving energy, time, water and detergent. However, if your cotton is particularly dirty, prewash with a protein-based detergent.

washing a load of laundry

Determining the load capacity

Do not overload the washing machine or your laundry may not wash properly. Use the chart below to determine the load capacity for the type of laundry you are washing.

Fabric Type	Load Capacity
Model	WF0754 / WF0752
Cotton - average/lightly soiled - heavily soiled	7.5 kg
Synthetics	3.0 kg
Denim	3.0 kg
Bedding	1.8 kg
Outdoor Wear	2.0 kg
Wool	2.0 kg

- When the laundry is unbalanced (“UE” lights up on the display), redistribute the load. If the laundry is unbalanced, the spin efficiency may be degraded.
- When washing Bedding or Duvet cover, the wash time may be lengthened or the spin efficiency may be degraded.
- For Bedding or Duvet cover, the recommended load capacity is 1.8 kg or less.

Make sure to insert brassieres (water washable) into a laundry net (to be purchased additionally).

- The metal parts of the brassieres may break through the material and damage the laundry. Therefore make sure to place them inside a fine laundry net.
- Small, light clothing such as socks, gloves, stockings and handkerchiefs may become caught around the door. Place them inside a fine laundry net.

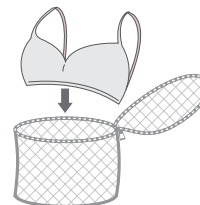

CAUTION Do not wash the laundry net by itself without other laundry. This may cause abnormal vibrations that could move the washing machine and cause an accident resulting in injury.

DETERGENT AND ADDITIVES INFORMATION

Which detergent to use

The type of detergent you should use is based on the type of fabric (cotton, synthetic, delicate items, wool), colour, wash temperature, and degree of soiling. Always use “low suds” laundry detergent, which is designed for automatic washing machines.

Follow the detergent manufacturer’s recommendations based on the weight of the laundry, the degree of soiling, and the hardness of the water in your area. If you do not know how hard your water is, enquire at your local water authority.

- Do not use detergent that has hardened or solidified as the detergent may remain in the rinse cycle. It may cause your washing machine to not rinse properly or result in the overflow becoming blocked.

Detergent drawer

Your washing machine has separate compartments for dispensing detergent and fabric softener. Add all laundry additives to the correct compartment before starting your washing machine.

 Do not open the detergent drawer while your washing machine is running or you might be exposed to hot water or steam.

1. Pull out the detergent drawer on the left side of the control panel.
2. Add the recommended amount of laundry detergent directly into the detergent compartment ① before starting your washing machine.

 To use liquid detergent, use the liquid detergent box (refer to “Liquid Detergent” for the corresponding model).

- Do not add powdered detergent into the liquid detergent box.
3. Add the recommended amount of fabric softener into the softener compartment ② if required. DO NOT exceed the MAX FILL (A) line.

 **CAUTION** Do NOT add any powder/liquid **detergent** to the softener compartment (②).

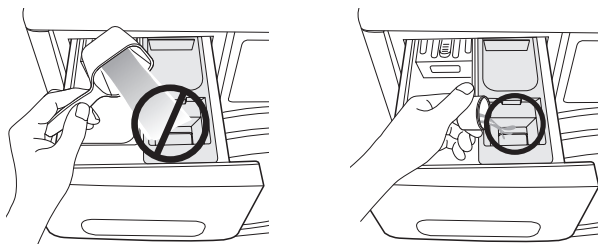
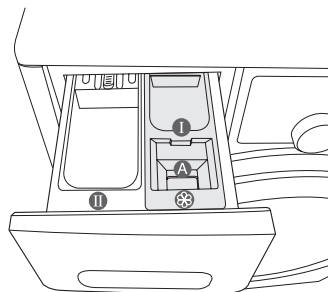

4. When using the Prewash option, add the recommended amount of laundry detergent into the prewash compartment ①.

 When washing large items do NOT use the following detergent types.

- Tablet and capsule type detergents
- Detergents using a ball and net

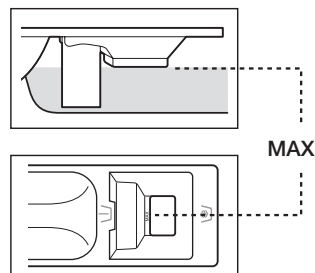

 Concentrated or thick fabric softener and conditioner must be diluted with a little water before being poured into the dispenser (prevents the overflow from becoming blocked).

 Be careful that the fabric softener does not overflow, when you close the detergent drawer after adding fabric softener into the rinse detergent compartment.



Liquid Detergent (Selected models)

To use liquid detergent, place the liquid detergent box into the main wash section of the detergent drawer and pour liquid detergent into the liquid detergent box.

-  • DO NOT fill above the MAX line.
-  • When using powdered detergent, remove the liquid detergent box from the detergent drawer. Powdered detergent will not dispense with liquid detergent box.
-  • After a wash, some liquid may remain in the detergent drawer.

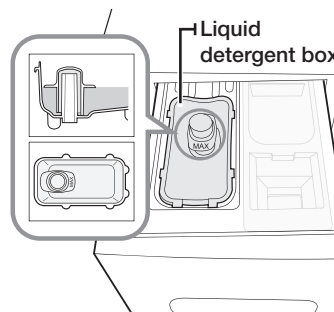

cleaning and maintaining your washing machine

Keeping your washing machine clean improves its performance, wards off unnecessary repairs, and lengthens its life.

HYGIENE DRUM CLEAN

This course is a self-cleaning course that removes mold that may occur inside the washing machine.

1. Press the **Power** button.
2. Turn the **Cycle Selector** to the Hygiene Drum Clean course.
 - You can only use the Delay End function.
 - The water temperature during the Hygiene Drum Clean is set to 60 °C.

 You cannot change the temperature.

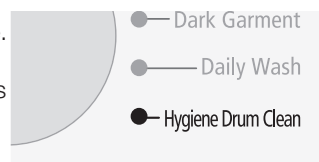

3. Place the appropriate amount of cleansing agent into the detergent compartment  and close the detergent drawer (when cleaning the drum using a cleansing agent).
 - Be sure to use the recommended cleansing agent for cleaning the drum.
 - There are powder-type and liquid-type drum cleansing agents. The liquid-type cleaning agent is only available with liquid detergent box (option).

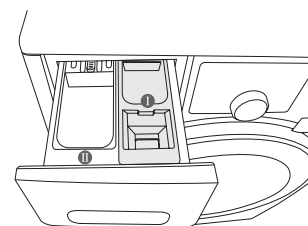

4. Press the **Start/Pause** button.
 - If you press the **Start/Pause** button, the Hygiene Drum Clean course begins.
-  CAUTION
- Using the Hygiene Drum Clean course, you can clean the drum without using a cleansing agent.
 - Never use the Hygiene Drum Clean course when laundry is in the washing machine. This may result in damage to the texture or a problem with the washing machine.
 - **In the Hygiene Drum Clean course, never use normal detergent.**
 - **Use only 1/10 of the amount of the drum cleansing agent recommended by the cleansing agent manufacturer.**
 - Since using a chlorine bleaching agent may discolour the product, be sure to use only oxygen bleaching agents.
 - Powder-type cleansing agent: Use a [powder-type bleaching agent] or a [cleansing agent for drum cleaning only].
 - Liquid-type cleansing agent: Use a [liquid-type oxygen bleaching agent] or a [cleansing agent for drum cleaning only].

The Hygiene Drum Clean Auto Alarm Function

- If the “Hygiene Drum Clean” indicator on the display and the lamp on the Cycle Selector are lit after a wash, it indicates that tub (drum) cleaning is required. In this case, remove the laundry from the washing machine, turn the power on, and clean the drum by performing the Hygiene Drum Clean course.
 - If you do not perform the Hygiene Drum Clean course, the “Hygiene Drum Clean” indicator on the display and the lamp on the Cycle Selector are turned off. However, the “Hygiene Drum Clean” indicator on the display and the lamp on the Cycle Selector are turned on again after two washes are performed. However, this will not result in a problem with the washing machine.
 - Although generally, the Hygiene Drum Clean Auto Alarm appears once a month or so, the frequency may differ depending on the number of times the washing machine is used.
-  • **In case of the alarm, please also clean the debris filter (refer to “Cleaning the debris filter” section on page 34). Otherwise the performance of the bubble function may lower down.**

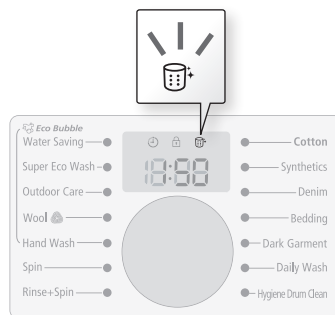

DRAINING THE WASHING MACHINE IN AN EMERGENCY

1. Unplug the washing machine from the power supply.
2. Open the filter cover by pressing down and pulling its handle.

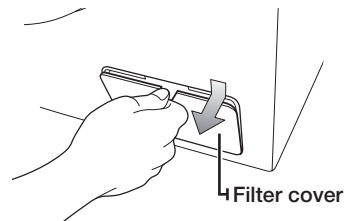

3. Open the emergency drain cap by pulling it.

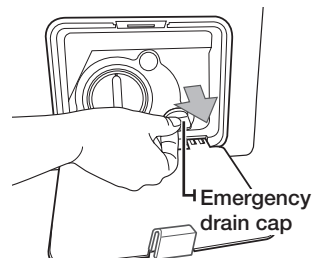

4. Hold the cap on the end of the emergency drain tube and slowly pull it out about 15 cm.
5. Allow all the water to flow into a bowl.

 Remain water maybe more than you expected. Prepare larger bowl.

6. Reinsert the emergency drain cap and the drain tube.
7. Replace the filter-cover.

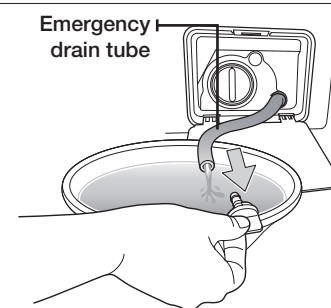

cleaning and maintaining your washing machine

CLEANING THE DEBRIS FILTER

We recommend cleaning the debris filter 5 or 6 times a year, or when the error message of “5E” is displayed. (Refer to “Draining the washing machine in an emergency” in the previous section.) If foreign substances accumulate debris filter, the performance of the bubble function will be degraded.



Before cleaning the debris filter, make sure to unplug the power cord.

1. Remove the remaining water first (refer to “Draining the washing machine in an emergency” on page 33.)
 If you separate the filter without draining the remaining water, the remaining water may trickle out.
2. Open the filter cover by using a key or coin.
3. Unscrew the emergency drain cap by turning it to the left and drain off all the water.
4. Unscrew the debris filter cap.
5. Wash any dirt or other material from the debris filter. Make sure the drain pump propeller behind the debris filter is not blocked.
6. Replace the debris filter cap.
7. Replace the filter cover.

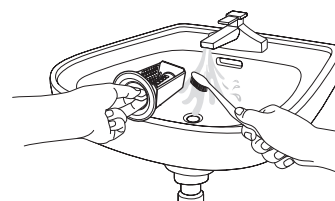
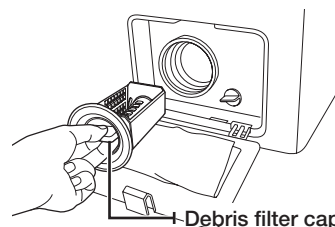

Do not open the debris filter cap while the machine is running or hot water may flow out.



- Make sure to replace the filter cap after the filter cleaning. If the filter is out of the machine, your washing machine may malfunction or leak water.
- The filter should be fully assembled after the filter cleaning.

CLEANING THE EXTERIOR

1. Wipe the washing machine surfaces, including the control panel, with a soft cloth using a nonabrasive household detergent.
2. Use a soft cloth to dry the surfaces.
3. Do not pour water onto the washing machine.

CLEANING THE DETERGENT DRAWER AND DRAWER RECESS

1. Press the release lever on the inside of the detergent drawer and pull the drawer out.
2. Remove the softener divider and the liquid detergent box(option) from the detergent drawer.

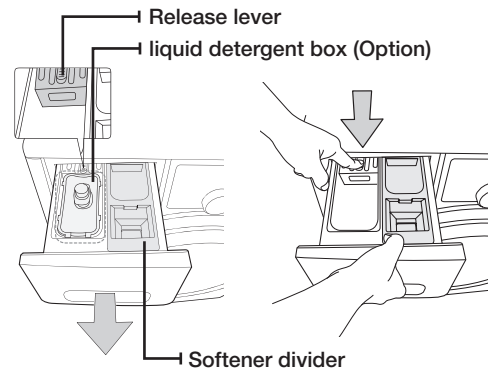

3. Wash all parts under running water.

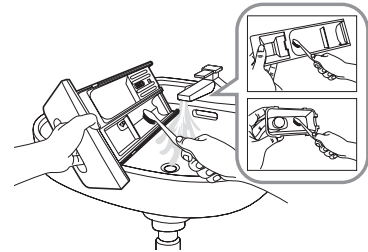

4. Clean the drawer recess with an old toothbrush.
5. Replace the softener divider and the liquid detergent box (option) by pushing it firmly into the drawer.
6. Push the drawer back into place.
7. To remove any remaining detergent, perform a rinse cycle without any laundry in the drum.

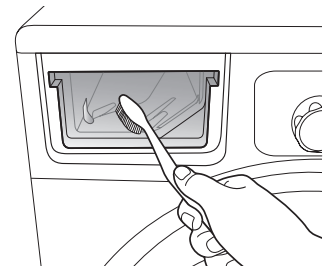

CLEANING THE WATER HOSE MESH FILTER

You should clean the water hose mesh filter at least once a year, or when the error message of “4E” is displayed:

1. Turn off the water supply to the washing machine.
2. Unscrew the hose from the back of the washing machine. To prevent water from gushing out due to the air pressure in the hose, cover the hose with a cloth.
3. Gently pull out the mesh filter from the end of the hose using a pair of pliers and rinse it under water until clean. Also clean inside and outside the threaded connector.
4. Push the filter back into place.
5. Screw the hose back onto the washing machine.
6. Make sure the connections are watertight and turn on the tap.

cleaning and maintaining your washing machine

REPAIRING A FROZEN WASHING MACHINE

If the temperature drops below freezing and your washing machine is frozen:

1. Unplug the washing machine.
2. Pour warm water over the tap to loosen the water supply hose.
3. Remove the water supply hose and soak it in warm water.
4. Pour warm water into the washing machine drum and let it sit for 10 minutes.
5. Reconnect the water supply hose to the water tap and check if the water supply and drain are operating normal.

STORING YOUR WASHING MACHINE

If you need to store your washing machine for an extended time, it's better to drain and disconnect it. Washing machines can be damaged if water is left in the hoses and internal components before storage.

1. Select the **Cotton** cycle and add bleach to the bleach compartment. Then, push the **Quick Wash** button and run your washing machine through the cycle without a load.
 2. Turn the water taps off and disconnect the inlet hoses.
 3. Unplug your washing machine from the electrical outlet, and leave your washing machine door open to allow air to circulate inside the tumbler.
-  If your washing machine has been stored in below-freezing temperatures, allow time for any leftover water in your washing machine to thaw out before using it.

troubleshooting and information codes

CHECK THESE POINTS IF YOUR WASHING MACHINE...

PROBLEM	SOLUTION
Will not start	<ul style="list-style-type: none">• Make sure your washing machine is plugged in.• Make sure the door is firmly closed.• Make sure the water source tap(s) are turned on.• Make sure to press the Start/Pause button.
Has no water or not enough water	<ul style="list-style-type: none">• Turn the water tap on fully.• Make sure the water source hose is not frozen.• Straighten the water intake hoses.• Clean the filter on the water intake hose.
Has detergent remaining in the detergent drawer after the wash cycle is complete	<ul style="list-style-type: none">• Make sure your washing machine is running with sufficient water pressure.• Make sure the detergent is added to the center of the detergent drawer.
Vibrates or is too noisy	<ul style="list-style-type: none">• Make sure your washing machine is on a level surface. If the surface is not level, adjust the washing machine feet to level the appliance.• Make sure that the shipping bolts are removed.• Make sure your washing machine is not touching any other object.• Make sure the laundry load is balanced.
The washing machine does not drain and/or spin	<ul style="list-style-type: none">• Straighten the drain hose. Eliminate kinked hoses.• Make sure the debris filter is not clogged.
Door is locked shut or will not open.	<ul style="list-style-type: none">• The door will not open until 3 minutes after the machine stops or the power turns off.

If the problem persists, contact your local Samsung Customer Service.

troubleshooting and information codes

INFORMATION CODES

If your washing machine malfunctions, you may see an information code on the display. If this happens, please check the table below and try the suggested solution before calling Customer Service.

CODE SYMBOL	SOLUTION
dE	<ul style="list-style-type: none">• Close the door.• Make sure the door is firmly closed.
4E	<ul style="list-style-type: none">• Make sure the source water tap is turned on.• Check the water pressure.• Clean the mesh filters of water hose.
5E	<ul style="list-style-type: none">• Clean the debris filter.• Make sure the drainage hose is installed correctly.• Clean the water hose mesh filter.
UE	<ul style="list-style-type: none">• The laundry load is unbalanced. Redistribute the load. If only one item of clothing needs washing, such as a bathrobe or pair of jeans, the final spin result might be unsatisfactory and an "UE" error message will be shown in the display window.
cE/3E/Uc	<ul style="list-style-type: none">• Call the after-sales service.

For any codes not listed above, or if the suggested solution doesn't fix the problem, call your Samsung Service Centre or local Samsung dealer.

cycle chart

CYCLE CHART

(● user option)

PROGRAM	Max load(kg)	DETERGENT			Max Temp (°C)	Spin Speed(MAX) rpm	
		Pre-wash	wash	Softener		WF0754	WF0752
Cotton	7.5	●	yes	●	95	1400	1200
Synthetics	3.0	●	yes	●	60	1200	1200
Denim	3.0	●	yes	●	60	800	800
Bedding	1.8	●	yes	●	40	800	800
Dark Garment	4.0	●	yes	●	40	1200	1200
Daily Wash	3.0	●	yes	●	60	1400	1200
Hygiene Drum Clean	-	-	-	-	60	400	400
Water Saving	7.5	●	yes	●	60	1200	1200
Super Eco Wash	4.0	-	yes	●	40	1200	1200
Outdoor Care	2.0	-	yes	●	40	1200	1200
Wool	2.0	-	yes	●	40	800	800
Hand Wash	2.0	-	yes	●	40	400	400





























PROGRAM	Eco Bubble	Intensive	Soak	Easy Iron	Delay end	Quick Wash	Cycle time (min)
Cotton	●	●	●	●	●	●	110
Synthetics	●	●	●	●	●	-	80
Denim	●	●	●	●	●	-	68
Bedding	●	●	●	●	●	-	87
Dark Garment	●	●	-	●	●	-	73
Daily Wash	●	-	●	●	●	-	54
Hygiene Drum Clean	-	-	-	-	●	-	86
Water Saving	●	●	●	●	●	-	135
Super Eco Wash	●	●	-	●	●	-	92
Outdoor Care	●	-	-	-	●	-	77
Wool	●	-	-	-	●	-	55
Hand Wash	●	-	-	-	●	-	31

1. A cycle with a prewash takes approx. 15 minutes longer.
2. The cycle duration data has been measured under the conditions specified in Standard IEC 60456 / EN 60456.
3. Cotton 60°C + intensive + Eco bubble are programs according to EN60456.
4. Daily Wash : Short program for test institutes.
5. Course time in individual homes may differ from the values given in the table due to variations in the pressure and temperature of the water supply, the load and the type of laundry.
6. When the Intensive Wash function is selected, the cycle time is increased for each cycle.

appendix

FABRIC CARE CHART

The following symbols provide garment care directions. The care labels include four symbols in this order: washing, bleaching, drying and ironing (and dry cleaning when necessary). The use of symbols ensures consistency among garment manufacturers of domestic and imported items. Follow the care label directions to maximize garment life and reduce laundry problems.

	Resistant material		Can be ironed at 100 °C max
	Delicate fabric		Do not iron
 	Item may be washed at 95 °C		Can be dry cleaned using any solvent
 	Item may be washed at 60 °C		Dry clean with perchloride, lighter fuel, pure alcohol or R113 only
 	Item may be washed at 40 °C		Dry clean with aviation fuel, pure alcohol or R113 only
 	Item may be washed at 30 °C		Do not dry clean
	Item may be hand washed		Dry flat
	Dry clean only		Can be hung to dry
	Can be bleached in cold water		Dry on clothes hanger
	Do not bleach		Tumble dry, normal heat
	Can be ironed at 200 °C max		Tumble dry, reduced heat
	Can be ironed at 150 °C max		Do not tumble dry

PROTECTING THE ENVIRONMENT

- This appliance is manufactured from recyclable materials. If you decide to dispose of this appliance, please observe local waste disposal regulations. Cut off the power cord so that the appliance cannot be connected to a power source. Remove the door so that animals and small children cannot get trapped inside the appliance.
- Do not exceed the detergent quantities recommended in the detergent manufacturers' instructions.
- Use stain removal products and bleaches before the wash cycle only when strictly necessary.
- Save water and electricity by only washing full loads (the exact amount depends upon the program used).

DECLARATION OF CONFORMITY

This appliance complies with European safety standards, EC directive 93/68 and EN Standard 60335.

SPECIFICATIONS

TYPE		FRONT LOADING WASHING MACHINE		
DIMENSIONS		WF0754 / WF0752		
		W598mm X D600mm X H844mm		
WATER PRESSURE		50 kPa ~ 800 kPa		
WATER VOLUME		49 ℓ		
NET WEIGHT		WF0754 / WF0752		
		67 kg		
WASH AND SPIN CAPACITY		7.5 kg		
POWER CONSUMPTION	MODEL	WF0754 / WF0752		
	WASHING	220 V	150 W	
		240 V	150 W	
	WASH AND HEATING	220 V	2000 W	
		240 V	2400 W	
	SPIN	MODEL	WF0754 / WF0752	
		230V	350 W	
PUMPING	34 W			
PACKAGE WEIGHT	MODEL	WF0754 / WF0752		
	PAPER	1.9 kg		
	PLASTIC	1.2 kg		
SPIN REVOLUTIONS	MODEL	WF0754	WF0752	
	rpm	1400	1200	

The appearance and specifications of the product are subject to change without prior notice for purposes of product enhancement.

memo

memo



QUESTIONS OR COMMENTS?

Country	CALL	OR VISIT US ONLINE AT
AUSTRALIA	1300 362 603	www.samsung.com

Code No. DC68-02875J_EN