

WD8704EJ(A/F/G/H/S/V/W/Z)  
WD8702EJ(A/F/G/H/S/V/W/Z)  
WD8704RJ(A/F/G/H/S/V/W/Z)  
WD8702RJ(A/F/G/H/S/V/W/Z)  
WD8704CJ(A/F/G/H/S/V/W/Z)  
WD8702CJ(A/F/G/H/S/V/W/Z)  
WD8704DJ(A/F/G/H/S/V/W/Z)  
WD8702DJ(A/F/G/H/S/V/W/Z)

# Washing Machine

## user manual

imagine the possibilities

Thank you for purchasing this Samsung product.  
To receive a more complete service, please  
register your product at

[www.samsung.com/register](http://www.samsung.com/register)



sonli  
.co  
line appliance

# features of your new samsung washing machine

Your new washing machine will change the way you feel about doing laundry. From its super-size capacity to its energy efficiency, the Samsung washing machine has all the features to turn a mundane chore into a pleasure.

- **Washing to drying with one button**

Enjoy convenient non stop washing and drying. 4 different special drying programs can be selected to perform the whole wash cycle including the drying cycle using one button.

- Cupboard(standard program), Low temp drying, Iron, Time Drying (30min ~ 270mins)  
Those drying programs also can be operated independently of washing programs.

- **Child Lock**

The Child Lock function ensures that curious little hands are kept out of your washing machine.

This safety feature stops your children from playing with the operation of the washing machine, and alerts you when it is activated.

- **Wool Certified**

The machine has been tested and passed the required Woolmark Company specification for machine washable wool products.

Fabrics should be washed according to the instructions on the garment label as specified by Woolmark and Samsung.

- **Delay End**

Delay a cycle for up to 19 hours in one-hour increments and increase the convenience of using your washing machine especially when you have to go out.

- **Quick Wash**

No time to lose! Less than 30 minutes wash will give you time to run out before it's too late.

Our 29 minute Quick Wash program can be the solution to your busy life. Now you can wash your favourite clothes in only 29 minutes!

- **Delicates & Hand Wash Program**

Washes clothes at an appropriate temperature and amount of water, with a gentle wash action to take special care of your clothes.

- **Ceramic Heater for Durability & Energy Saving (selected models)**

The ceramic heating element has a high resistance to hard water and detergents thereby ensuring it has a long life span.

## • Air Refresh

The Air Refresh system deodorizes and sterilizes fabrics without getting them wet, opening up cleaning options for many non washable items. The sterilization function also kills the common household dust mite, offering relief for allergy sufferers.

- Air-washable : Cottons; Denims; Synthetics; Woollens – including coats, blankets, quilts, sweaters; suits; pillows; cushions; needlework; soft toys – such as teddy bears.
- Not applicable : Leather, Silk, Velvet, Electric Blankets. This function will not remove stains from fabrics.

## • Digital Graphic Display

The Digital Graphic Display control panel is clear and easy to use for minimum fuss and hassle. And while it is easy to operate, the Digital Graphic Display enables you to make quick and accurate adjustments to your wash for excellent washing results.

## • Wide door

Extra wide door aperture for convenient viewing! Easily add and remove laundry, especially for large sized laundry items such as bedding, towels etc.

## • Direct Drive Motor

As the drum does not utilize belts or gears, vibrations are reduced significantly. This feature ensures that your washer machine is quieter and more durable.



This manual contains important information on the installation, use, and care of your new Samsung washing machine. Refer to it for descriptions of the control panel, instructions on how to use the washing machine, and tips for making the most of its state-of-the-art features and functions. The “**Troubleshooting and information codes**” section on page 29 tells you what to do if something goes wrong with your new washing machine.



**appliancesonline**.co













Australia's largest online appliance retailer  
features \_3

# safety information

Throughout this manual, you'll see Warning  and Caution  notes. These warnings, cautions, and the important safety instructions that follow do not cover all possible conditions and situations that may occur. It's your responsibility to use common sense, caution, and care when installing, maintaining, and operating your washing machine. Samsung is not liable for damages resulting from improper use.

## IMPORTANT SAFETY SYMBOLS AND PRECAUTIONS

### What the icons and signs in this user manual mean:

 <b>WARNING</b>	Hazards or unsafe practices that may result in <b>severe personal injury or death.</b>
 <b>CAUTION</b>	Hazards or unsafe practices that may result in <b>minor personal injury or property damage.</b>
 <b>CAUTION</b>	To reduce the risk of fire, explosion, electric shock, or personal injury when using your washing machine, follow these basic safety precautions:
 <b>CAUTION</b>	To reduce the risk of fire or explosion, follow these basic precautions.
	Do NOT attempt.
	Do NOT disassemble.
	Do NOT touch.
	Follow directions explicitly.
	Unplug the power plug from the wall socket.
	Make sure the machine is grounded to prevent electric shock.
	Call the service center for help.
	Notice

**These warning signs are here to prevent injury to you and others.**

**Please follow them explicitly.**

**After reading this section, keep it in a safe place for future reference.**

-  Read all instructions before using the appliance.

As with any equipment using electricity and moving parts, potential hazards exist. To safely operate this appliance, become familiar with its operation and exercise care when using it.

Install and store your washing machine inside, away from exposure to weather.

Install and level your washing machine on a floor that can support its weight.

-  Your washing machine must be properly grounded. Never plug it into an ungrounded outlet.



To reduce the risk of fire or explosion:

- Do not wash items that have been washed, soaked, or treated with gasoline, dry cleaning solvents, or other flammable or explosive substances. They give off vapors that could ignite or explode. Rinse by hand any material that has been exposed to cleaning solvent or other flammable liquids or solids before putting in your washing machine. Be sure that all traces of such liquids, solids, and fumes have been removed. Dangerous substances include acetone, denatured alcohol, gasoline, kerosene, certain liquid household cleaners and spot removers, turpentine, waxes, and wax removers.
- Do not put gasoline, dry cleaning solvents, or other flammable or explosive substances into the washing machine.
- Under certain conditions, hydrogen gas may be produced in a hot water system—such as your hot water heater -- that has not been used for two weeks or more. **HYDROGEN GAS IS EXPLOSIVE.** If your hot water system has not been used for two weeks or more, turn on all hot water taps in your home, and let the water flow for several minutes before using your washing machine. This will release any hydrogen gas build-up. Since hydrogen gas is flammable, do not smoke or light an open flame during this time.

Ventilate immediately without touching the power plug if there is a gas leak.



Unplug the power cord before servicing your washing machine.

Before each wash, empty the pockets of your laundry. Small, irregularly shaped hard objects, such as coins, knives, pins, and paperclips could damage your washing machine. Do not wash clothing with large buckles, buttons, or other heavy metal.

Do not open the door of the washing machine if you can still see water. Check that the water has drained before opening the door.



Do not repair, replace, or service any part of your washing machine yourself unless you fully understand the recommended user-repair instructions and have the skills to carry them out. Work done by an unauthorized person may void your warranty.

Connect the washing machine to the water mains using the new set of hoses. Do not reuse the old set of hoses.

Water inlet hoses deteriorate over time. Check the hoses periodically for bulges, kinks, cuts, wear, and leaks, and replace them as needed and at least every five years.

All packaging and shipping bolts must be removed before the appliance is used. Serious damage may occur if they are not removed. See page 12 “Removing the shipping bolts”.



Before washing clothes for the first time, you must run a complete cycle without clothes. See “Washing for the first time”.

If this appliance is supplied from a cord extension set or electrical portable outlet device, the cord extension set or electrical portable outlet device must be positioned so that it is not subject to splashing or ingress of moisture.



**appliancesonline**.co

Australia's largest online appliance retailer

safety information \_5

# safety information

The appliance is designed for home use only.

 **WARNING** Make sure that water and electrical connections are made by qualified technicians, observing the user manual (see “Installing your washing machine”) and local safety regulations.

 Before cleaning or carrying out maintenance, unplug the appliance from the electrical outlet.

Always unplug the appliance and turn off the water after use.

Make sure that the pockets of all clothing to be washed are empty.

Hard, sharp objects, such as coins, safety pins, nails, screws, or stones can cause extensive damage to the appliance.

Never allow pets and children to play on or in the appliance. It may cause injury or suffocate them.

The glass door becomes very hot during the washing cycle. Never touch the glass door while it is in use.

 Do not attempt to repair the appliance yourself. Repairs made by inexperienced or unqualified persons may cause injury and/or make more serious repairs to the appliance necessary.

If the plug (power supply cord) is damaged, it must be replaced by the manufacturer or its service agent or a similarly qualified person in order to avoid a hazard.

This appliance should only be serviced by our authorized service center, and only rated spare parts should be used.

 **WARNING** Do not let children (or pets) play on or in your washing machine. The washing machine door does not open easily from the inside, and children may be seriously injured if trapped inside.

 **WARNING** This appliance is not intended for use by persons (including children) with reduced physical, sensory or mental capabilities, or lack of experience and knowledge, unless they have been given supervision or instruction concerning use of the appliance by a person responsible for their safety.

Children should be supervised to ensure that they do not play with the appliance.

To use this appliance safely, the user should become familiar with the instructions for operation of the appliance and always take extra care when using it.

This appliance should be positioned to be accessible to the power plug, the water supply tabs and the drain pipes.

 **WARNING** Packing materials can be dangerous to children; keep all packing material (plastic bags, polystyrene, etc.) well out of the reach of children.

Do not use processed water containing oil, cream or lotion, which is usually found in skincare shops or massage clinics.

- Otherwise this will cause the packing to be deformed, which causes a malfunction or water leak.

A stainless washing tub does not usually rust. However if some metal such as a hair pin is left in the tub for an extended time, the tub could rust.

- Do not leave water or bleach containing chlorine in the tub for an extended period of time.
- Do not regularly use or leave water containing iron in the tub for an extended period of time. If rust starts appearing on the surface of the tub, apply a cleansing agent (neutral) to the surface and use a sponge or soft cloth to clean it. (Under no circumstances use a metal brush)

The dryer is not to be used if chemicals have been used for cleaning.

For washing machines with ventilation openings in the base, ensure that the opening is not obstructed by carpet or any other obstacles.

Use the new hose-sets and old hose-sets should not be reused.





**To minimize the risk of fire in a tumble dryer, the following should be observed:**

CAUTION

Items that have been spotted or soaked with vegetable or cooking oil constitute a fire hazard and should not be placed in a tumble dryer. Oil-affected items can ignite spontaneously, especially when exposed to heat sources such as in a tumble dryer. The items become warm, causing an oxidation reaction in the oil. Oxidation creates heat. If the heat cannot escape, the items can become hot enough to catch fire. Piling, stacking or storing oil-affected items can prevent heat from escaping and so create a fire hazard. If it is unavoidable that fabrics that contain vegetable or cooking oil or have been contaminated by hair care products be placed in a tumble dryer they should first be washed in hot water with extra detergent – this will reduce, but not eliminate, the hazard. The 'cool down' cycle of tumble dryers should be used to reduce the temperature of the items. They should not be removed from the tumble dryer or piled or stacked while hot.

Items that have been previously cleaned in, washed in, soaked in or spotted with petrol/gasoline, dry-cleaning solvents or other flammable or explosive substances should not be placed in a tumble dryer. Highly flammable substances commonly used in domestic environments include acetone, denatured alcohol, petrol/gasoline, kerosene, spot removers(some brands), turpentine, waxes and wax removers.

Items containing foam rubber(also known as latex foam) or similarly textured rubber. Like materials should not be dried in a tumble dryer on a heat setting. Foam rubber materials can, when heated, produce fire by spontaneous combustion.

Fabric softeners or similar products should not be used in a tumble dryer to eliminate the effects of static electricity unless this practice is specifically recommended by the manufacturer of the fabric softener or product.

Undergarments that contain metal reinforcements should not be placed in a tumble dryer. Damage to the tumble dryer can result if metal reinforcements come loose during drying. When available a drying rack could be used for such items.

Plastic articles such as shower caps or babies' waterproof napkin covers should not be placed in a tumble dryer.

Rubber-backed articles, clothes fitted with foam rubber pads, pillows, galoshes and rubber-coated tennis shoes should not be placed in a tumble dryer.



WARNING

Do not dry unwashed items in the tumble dryer(or washing machine drying mode,etc).

Items that have been soiled with substances such as cooking oil, acetone, alcohol, petrol, Kerosene, spot removers, turpentine, waxes and wax removers should be washed in hot water with an extra amount of detergent before being dried in the tumble dryer.

Items such as foam rubber(latex foam), shower caps, waterproof textiles, rubber backed articles and clothes or pillows fitted with foam rubber pads should not be dried in the tumble dryer.

Fabric softeners, or similar products, should be used as specified by the fabric softener instructions.

The final part of a tumble dryer cycle occurs without heat(cool down cycle) to ensure that the items are left at a temperature that ensures that the items will not be damaged.

Oil-affected items can ignite spontaneously, especially when exposed to heat sources such as in a tumble dryer. The items become warm, causing an oxidation reaction in the oil. Oxidation creates heat. If the heat cannot escape, the items can become hot enough to catch fire. Piling, stacking or storing oil-affected items can prevent heat from escaping and so create a fire hazard.

If it is unavoidable that fabrics that contain vegetable or cooking oil or have been contaminated by hair care products be placed in a tumble dryer they should first be washed in hot water with extra detergent - this will reduce, but not eliminate, the hazard.



CAUTION

Never stop a tumble dryer before the end of the drying cycle unless all items are quickly removed and spread out so that the heat is dissipated.



**appliancesonline**.co

Australia's largest online appliance

safety information \_7

# contents

## SETTING UP YOUR WASHING MACHINE

9

- 9 Checking the parts
- 10 Meeting installation requirements
  - 10 Electrical supply and grounding
  - 10 Water Supply
  - 11 Drain
  - 11 Flooring
  - 11 Surrounding temperature
  - 11 Alcove or closet installation
- 11 Installing your washing machine
- 16 Environment

## WASHING A LOAD OF LAUNDRY

17

- 17 Washing for the first time
- 17 Basic instructions
- 18 Using the control panel
  - 21 Child lock
  - 21 Sound off
  - 21 Delay end
  - 21 Drain Only Function
  - 22 Air Refresh
- 23 Drying
  - 25 Washing clothes using the cycle selector
  - 25 Washing clothes manually
- 26 LAUNDRY GUIDELINES
- 27 Detergent and additives information
  - 27 Which detergent to use
  - 27 Detergent drawer

## CLEANING AND MAINTAINING YOUR WASHING MACHINE

28

- 28 Draining the washing machine in an emergency
- 28 Cleaning the exterior
- 29 Cleaning the detergent drawer and drawer recess
- 29 Cleaning the debris filter
- 30 Cleaning the water hose mesh filter
- 30 Repairing a frozen washing machine
- 30 Storing your washing machine

## TROUBLESHOOTING AND INFORMATION CODES

31

- 31 Check these points if your washing machine...
- 32 Information codes

## CYCLE CHART

33

- 33 Cycle chart

## APPENDIX

34

- 34 Fabric care chart
- 34 Protecting the environment
- 34 Declaration of conformity





# setting up your washing machine

Be sure to have your installer follow these instructions closely so that your new washing machine works properly and so that you're not at risk of injury when doing laundry.

## CHECKING THE PARTS

Carefully unpack your washing machine, and make sure you've received all of the parts shown below. If your washing machine was damaged during shipping, or if you do not have all of the parts, contact Samsung Customer Service or your Samsung dealer.

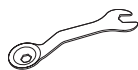
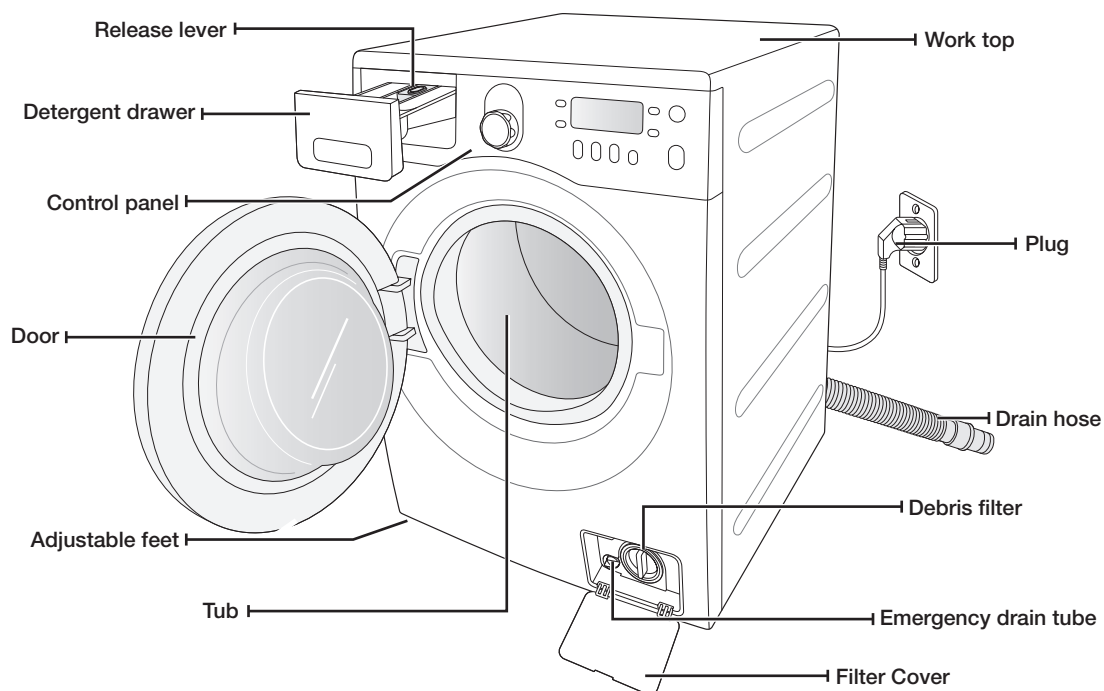

Spanner

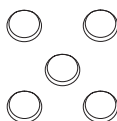

Bolt hole covers



Water supply hose



Hose guide



# setting up your washing machine

## MEETING INSTALLATION REQUIREMENTS

### Electrical supply and grounding

To prevent unnecessary risk of fire, electrical shock, or personal injury, all wiring and grounding must be done in accordance with the National Electrical Code ANSI/FNPA, No. 70 Latest Revision and local codes and ordinances. It is the personal responsibility of the appliance owner to provide adequate electrical service for this appliance.

 Never use an extension cord.  
**WARNING** Use only the power cord that comes with your washing machine.

When preparing for installation, ensure that your power supply offers:

- 220V~240V 50Hz 15 AMP fuse or circuit breaker
- Individual branch circuit serving only your washing machine

Your washing machine must be grounded. If your washing machine malfunctions or breaks down, grounding will reduce the risk of electric shock by providing a path of least resistance for the electric current.

Your washing machine comes with a power cord having a three-prong grounding plug for use in a properly installed and grounded outlet.

 Never connect the ground wire to plastic plumbing lines, gas lines, or hot water pipes.

Improperly connecting the equipment-grounding conductor can result electrical shock. Check with a qualified electrician or serviceman if you are unsure if the washing machine is properly grounded. Do not modify the plug provided with the washing machine. If it does not fit the outlet, have a proper outlet installed by a qualified electrician.

### Water Supply

Your washing machine will fill properly when your water pressure is 50 kPa ~ 800 kPa. Water pressure less than 50 kPa may cause water valve failure, not allowing the water valve to shut off completely. Or, it may take the washing machine longer to fill than what the controls allow, resulting in your washing machine turning off. (A fill-time limit, designed to prevent overflows/flooding if an internal hose becomes loose, is built into the controls.)

The water taps must be within 4 feet (122cm) of the back of your washing machine for the provided inlet hoses provided to reach your washing machine.

 Most plumbing supply stores sell inlet hoses of various lengths up to 10 feet (305cm) long.

You can reduce the risk of leaks and water damage by:

- Making water taps easily accessible.
- Turning off taps when the washing machine is not in use.
- Periodically checking for leaks at water inlet hose fittings.

 Before using your washing machine for the first time, check all connections at the water valve and taps for leaks.  
**WARNING**



## Drain

Samsung recommends a standpipe height of 18 in (46 cm). The drain hose must be routed through the drain hose clip to the standpipe. The standpipe must be large enough to accept the outside diameter of the drain hose. The drain hose is attached at the factory.

## Flooring

For best performance, your washing machine must be installed on a solidly constructed floor. Wood floors may need to be reinforced to minimize vibration and/or unbalanced loads. Carpeting and soft tile surfaces are contributing factors to vibrations and the tendency for your washing machine to move slightly during the spin cycle.

Never install your washing machine on a platform or poorly supported structure.

## Surrounding temperature

Do not install your washing machine in areas where water may freeze, since your washing machine always retains some water in its water valve, pump, and hose areas. Frozen water in the lines can cause damage to belts, the pump, and other components.

## Alcove or closet installation

To operate safely and properly, your new washing machine requires minimum clearances of:

Sides – 25 mm

Rear – 51 mm

Top – 25 mm

Front – 465 mm

If both the washing machine and a dryer are installed together, the front of the alcove or closet must have at least 465 mm unobstructed air opening. Your washing machine alone does not require a specific air opening.

# INSTALLING YOUR WASHING MACHINE

## STEP 1

### Selecting a location



Before you install the washing machine, make sure the location:

- Has a hard, level surface without carpeting or flooring that may obstruct ventilation
- Is away from direct sunlight
- Has adequate ventilation
- Will not be freezing (below 32 °F or 0 °C)
- Is away from heat sources such as oil or gas
- Has enough space so that the washing machine doesn't stand on its power cord



appliancesonline.com

Australia's largest online appliance retailer

setting up your new washing machine \_11



# setting up your washing machine

## STEP 2

### Removing the shipping bolts

Before installing the washing machine, you must remove the five shipping bolts from the back of the unit.

1. Loosen all the bolts with the supplied wrench.

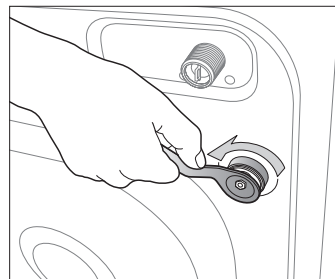

2. Hold the bolt with the spanner and pull it through the wide section of the hole. Repeat for each bolt.

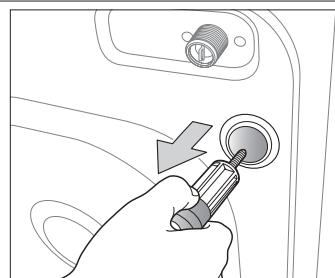

3. Fill the holes with the supplied plastic covers.

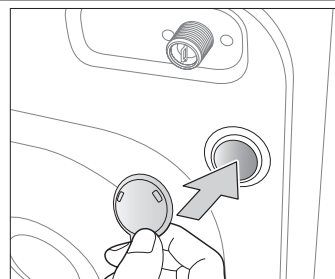

4. Store the shipping bolts away safely in case you have to move the washing machine in the future.

 **WARNING** Packaging materials can be dangerous to children; keep all packaging material (plastic bags, polystyrene, etc.) well out of the reach of children.



## STEP 3

### Adjusting the levelling feet

 When installing your washing machine, ensure that the power plug, the water supply and the drain are easily accessible.

1. Slide the washing machine into position.

2. Level your washing machine by turning the leveling feet in and out as necessary by hand.

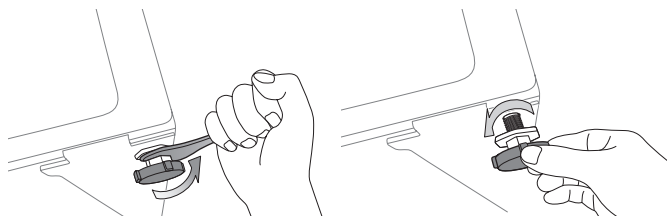

3. When your washing machine is level, tighten the nuts using the wrench supplied with your washing machine.

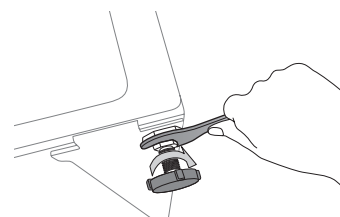

## STEP 4

### Connecting the water and drain

#### Connecting the water supply hose

1. Take the L-shaped arm fitting for the cold water supply hose and connect it to the cold water supply intake on the back of the machine. Tighten by hand.

 The water supply hose must be connected to the washing machine at one end and to the water tap at the other. Do not stretch the water supply hose. If the hose is too short, replace the hose with a longer, high pressure hose.

2. Connect the other end of the cold water supply hose to your sink's cold water tap and tighten it by hand. If necessary, you can reposition the water supply hose at the washing machine end by loosening the fitting, rotating the hose, and retightening the fitting.

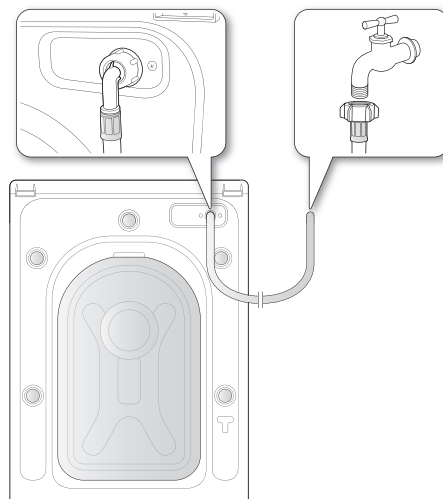

#### For selected models with an additional hot water intake:

1. Take the red L-shaped arm fitting for the hot water supply hose and connect it to the hot water supply intake on the back of the machine. Tighten by hand.
2. Connect the other end of the hot water supply hose to your sink's hot water tap and tighten it by hand.
3. Use a Y-piece if you only want to use cold water.



appliancesonline.com.au

Australia's largest online appliance retailer

setting up your new washing machine \_13



# setting up your washing machine

## Connecting the water supply hose (selected models)

1. Remove the adaptor from the water supply hose.

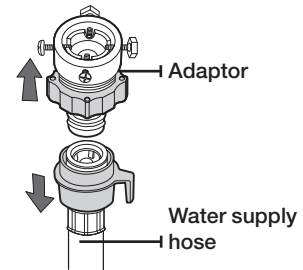

2. First, using a '+' type screwdriver, loosen the four screws on the adaptor. Next, take the adaptor and turn part (2) following the arrow until there is a 5 mm gap.

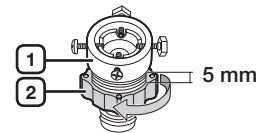

3. Connect the adaptor to the water tap by tightening the screws firmly while lifting the adaptor upwards. Turn part (2) following the arrow and connect (1) and (2).

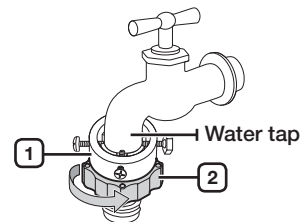

4. Connect the water supply hose to the adaptor. When you release part (3), the hose automatically connects to the adaptor making a 'click' sound.

 After you have connected the water supply hose to the adaptor, ensure that it is connected correctly by pulling the water supply hose downwards.

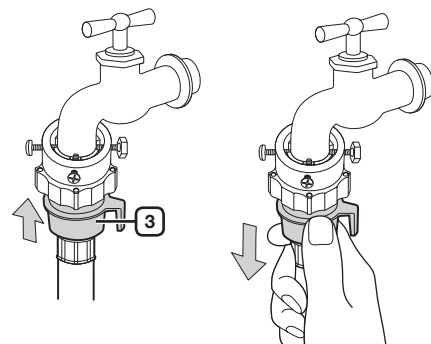

5. Connect the other end of the water supply hose to the inlet water valve at the rear of the washing machine. Screw the hose clockwise all the way in.

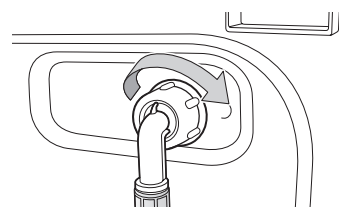



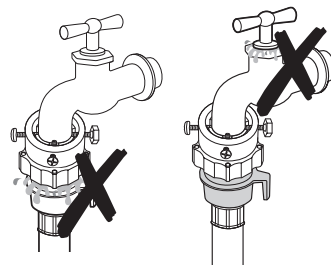

6. Turn on the water supply and ensure that no water leaks from the water valve, tap or adaptor. If there is a water leak, repeat the previous steps.

 **WARNING** Do not use your washing machine if there is a water leak. This may cause electric shock or injury.

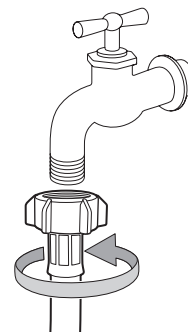

- If the water tap has a screw type tap, connect the water supply hose to the tap as shown.



-  Use the most conventional type of tap for the water supply. In case the tap is square or too big, remove the spacing ring before inserting the tap into the adaptor.





# setting up your washing machine

## Connecting the drain hose

The end of the drain hose can be positioned in three ways:

1. **Over the edge of a wash basin:** The drain hose must be placed at a height of between 60 and 90 cm. To keep the drain hose spout bent, use the supplied plastic hose guide. Secure the guide to the wall with a hook or to the tap with a piece of string to prevent the drain hose from moving.

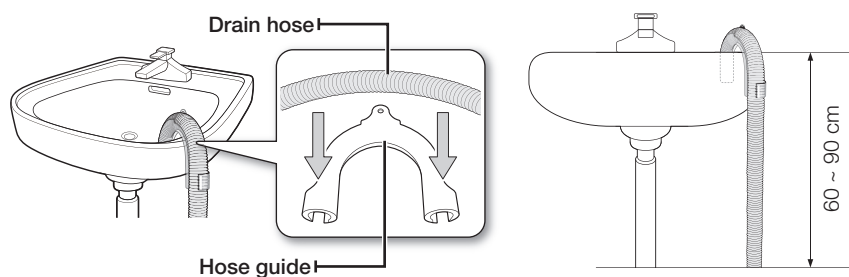

2. **In a sink drain pipe branch:** The drain pipe branch must be above the sink siphon so that the end of the hose is at least 60 cm above the ground.
3. **In a drain pipe:** We recommend using a 65 cm high vertical pipe; it must be no shorter than 60 cm and no longer than 90 cm.

## STEP 5

### Powering your washing machine

Plug the power cord into a wall sockets, a 230 volt 50 Hz approved electrical outlet protected by a 15-amp fuse or comparable circuit breaker. (For more information on electrical and grounding requirements, see page 10.)

## ENVIRONMENT

Please dispose of the packaging materials for this product in an "environmentally friendly" manner. For further detail, please contact your local area authority.

# washing a load of laundry

With your new Samsung washing machine, the hardest part of doing laundry will be deciding which load to wash first.

## WASHING FOR THE FIRST TIME

 Before washing laundry for the first time, you must run a complete empty cycle (i.e. no laundry).

1. Press the **Power** button.
2. Add a little detergent to the detergent compartment ② in the detergent drawer.
3. Turn on the water supply to the washing machine.
4. Press the **Start/Pause** button.

 This will remove any water that might be left over in the machine from the manufacturer's test run.

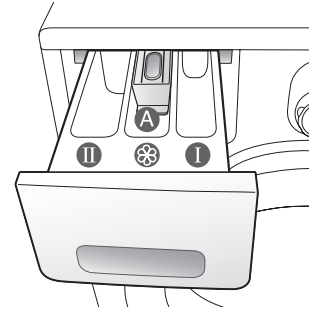

**Compartment ①:** Detergent for prewash, or starch.

**Compartment ②:** Detergent for the main wash, water softener, pre-soaking agent, bleach and stain removal product.

**Compartment ③:** Additives, e.g. fabric softener or former (fill no higher than lower edge (MAX) of "A")

## BASIC INSTRUCTIONS

1. Load your laundry into the washing machine.

 **WARNING** Do not overload the washing machine. To determine the load capacity for each type of laundry, refer to the chart on page 24.

-  • Make sure that laundry is not caught in the door, as this may cause a water leak.
- Washing detergent may remain in the front rubber part of the washer after a wash cycle. Remove any remaining detergent, as they may cause a water leak.
- Do not wash water-proofed items.
2. Close the door until it latches.
  3. Turn the power on.
  4. Add detergent and additives to the dispenser drawer.
  5. Select the appropriate cycle and options for the load.  
The Wash Indicator light will illuminate and the estimated cycle time will appear in the display.
  6. Press the **Start/Pause** button.







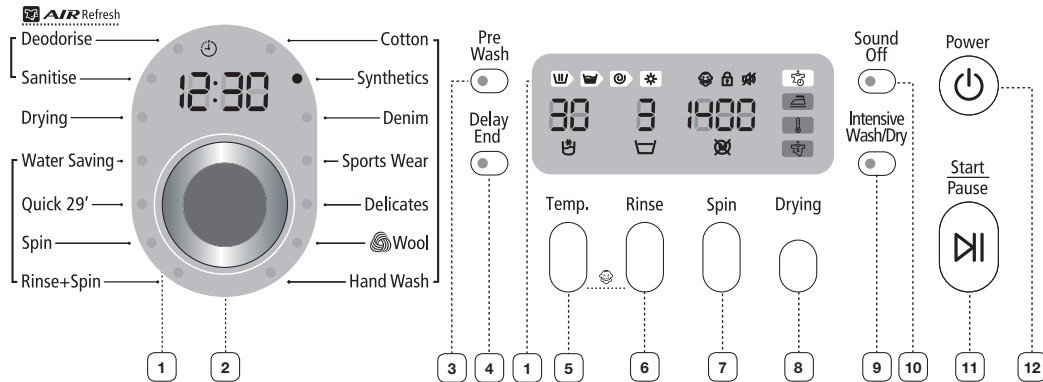

















# washing a load of laundry

## USING THE CONTROL PANEL



<p><b>1 DIGITAL GRAPHIC DISPLAY</b></p>	<p>Displays the remaining wash cycle time, all cycle information, and error messages.</p>
<p><b>2 CYCLE SELECTOR</b></p>	<p>Select the tumble pattern and spin speed for the cycle.</p> <p> For detailed information, refer to “Washing clothes using the cycle selector”. (see page 22)</p> <p><b>Cotton</b> - For lightly soiled cottons, bed linen, table linen, underwear, towels, shirts, etc.</p> <p><b>Synthetics</b> - For averagely or lightly soiled blouses, shirts, etc., made of polyester (diolen, trevira), polyamide (perlon, nylon) or other similar blends.</p> <p><b>Denim</b> - A higher water level in the main wash and extra rinse ensure that no washing powder remains that may mark your clothing.</p> <p><b>Sports Wear</b> - Use for water-proofed or proofed garments to keep their good looks and fresh feel.</p> <p><b>Delicates</b> - For sheer fabrics, brassieres, lingerie, dresses, shirts and blouses. For best results, use liquid detergent.</p> <p><b>Wool</b> - Only for machine-washable wool. A load should be less than 2.0 kg.</p> <ul style="list-style-type: none"> <li>The wool course washes the laundry using gentle cradling actions. During the wash, the gentle cradling and soaking actions are continued to protect the wool fibers from shrinkage / distortion and for a super gentle clean. This stop operation is not a problem.</li> <li>Neutral detergent is recommended for wool course, for improved washing results and for improved care of the wool fibers.</li> </ul> <p> The wool wash cycle of this machine has been approved by Woolmark for the washing of machine-washable Woolmark products provided that the products are washed according to the instructions on the garment label and those issued by the manufacturer of this washing machine, M0509 (Certificate Number issued by IWS NOM INEE Co., Ltd.)</p> <p><b>Handwash</b> - A very light wash cycle as gentle as a hand wash.</p> <p><b>Air Refresh</b> - Use this system to deodorize or sanitize fabrics excluding silk, leather and velvet.</p> <ul style="list-style-type: none"> <li>Deodorise cycle – Removes odours from laundry</li> <li>Sanitise cycle – Removes odours and bacteria from laundry</li> </ul> <p><b>Drying</b> - Dry only function. Will dry clothes without washing them first. Uses a sensor to determine drying time.</p> <p><b>Water Saving</b> - This is a specially designed course that enables you to wash laundry effectively with the minimum amount of water. Water Saving, 40°C, Intensive Wash/Dry, 3 rinses, 1400rpm spin is recommended for a normally soiled load.</p>



	<p><b>Quick 29'</b> - Washes laundry in 29 minutes. For lightly soiled garments.</p> <p><b>Spin</b> - Performs an additional spin cycle to remove more water.</p> <p><b>Rinse + Spin</b> - Use for a load that needs rinsing only or to add rinse-added fabric softener to a load.</p> <p><b>Drain Only</b> - Turn the <b>Cycle Selector</b> to the Spin position, press the <b>Spin</b> button, and then press the <b>Start/Pause</b> button to drain the water.</p>				
3	<p><b>PREWASH SELECTION BUTTON</b></p> <p>Press this button to select pre-wash. Pre-wash is only available with: Cotton, Synthetics, Denim, Sports Wear.</p>				
4	<p><b>DELAY END SELECTION BUTTON</b></p> <p>Press this button repeatedly to cycle through the available Delay End options (from 3 hours to 19 hours in one hour increments). The hour displayed indicates the time when the wash cycle will be finished.</p>				
5	<p><b>TEMPERATURE SELECTION BUTTON</b></p> <p>Press this button repeatedly to cycle through the available water temperature options: (Cold Water , 30 °C, 40 °C, 60 °C and 95 °C).</p>				
6	<p><b>RINSE SELECTION BUTTON</b></p> <p>Press this button to add additional rinse cycles. The maximum number of rinse cycles is five.</p>				
7	<p><b>SPIN SELECTION BUTTON</b></p> <p>Press the button repeatedly to cycle through the available speeds for the spin cycle.</p> <table border="1" data-bbox="559 849 1300 942"> <tr> <td>WD8704</td> <td>, , 400, 800, 1200, 1400 rpm</td> </tr> <tr> <td>WD8702</td> <td>, , 400, 800, 1000, 1200 rpm</td> </tr> </table>	WD8704	 ,  , 400, 800, 1200, 1400 rpm	WD8702	 ,  , 400, 800, 1000, 1200 rpm
	WD8704	 ,  , 400, 800, 1200, 1400 rpm			
WD8702	 ,  , 400, 800, 1000, 1200 rpm				
8	<p><b>DRYING BUTTON</b></p> <p>Only include items that are suitable for both washing and drying when using the wash + dry program, as non dryable items may be deformed, even at low temperatures.</p> <p><b>Cup Board</b>  → <b>Low Temp</b>  → <b>Iron</b>  → <b>Time Dry</b>  (47min. → 1:17min. → 1:47min. → 2:17min. → 2:47min. → 3: 17min. → 3: 47min. → 4: 17min. → 4:47min.) → <b>Cup Board</b></p> <p><b>"Cup Board </b>" - Clothes are dried to a level that is suitable for them to be placed directly in the cupboard at the end of the cycle. Using sensors, the machine will automatically set the length of time required to dry laundry.</p> <p><b>"Low Temp </b>" - Designed for heat sensitive items. Dries laundry at a lower temperature using sensor to determine drying time.</p> <p><b>"Iron </b>" - Suitable for laundry that will be ironed immediately after cycle end. Leaves laundry slightly moist to make ironing easier. Sensor determines drying time.</p> <p><b>"Time Dry </b>" -Allows you to select the length of drying time (30min. → 60min. → 90min. → (47min. → 1:17min. → 1:47min. → 2:17min. → 2:47min. → 3: 17min. → 3: 47min. → 4: 17min. → 4:47min.)</p> <ul style="list-style-type: none"> <li> You must avoid washing laundry that may not be dried as it may be deformed even at low temperatures.</li> <li>The Cup Board, Low Temp, Iron and Time Dry options detect the weight of the laundry in order to display an accurate drying time and dry them more completely.</li> <li>The drying conditions may differ depending on the type and the amount of laundry.</li> </ul>				



# washing a load of laundry

<b>9 INTENSIVE WASH / DRY SELECTION BUTTON</b>	Press this button when the laundry is heavily soiled and needs to be washed intensively. The cycle time is increased for each cycle. Turn the Cycle Selector to the Drying position and press this button to use the 4 kg high-capacity drying function.
<b>10 SOUND OFF BUTTON</b>	The sound can be turned off for all courses. When this function is selected, the sound is turned off for all cycles. <ul style="list-style-type: none"><li>• When the Sound off function is activated, the lamp on the <b>Sound Off</b> button and the control panel are illuminated.</li><li>• When the Sound off function is deactivated, a buzzer will go off, and the lamp on the button and the control panel is turned off.</li></ul>
<b>11 START/PAUSE SELECTION BUTTON</b>	Press to pause and restart a cycle.
<b>12 POWER BUTTON</b>	Press it once to turn your washing machine on, press it again to turn your washing machine off. If the washing machine is left on for more than 10 minutes without any buttons being touched, the power automatically turns off.

## Child lock

The Child Lock function allows you to lock the buttons so that the wash cycle you've chosen can't be changed.

### Activating/Deactivating

If you want to activate or deactivate the Child Lock function, press the **Temp.** and **Rinse** buttons at the same time for 3 seconds. "Child Lock" will be lit when this feature is activated, so it communicates that the Child Lock icon will be lit when the feature is activated.

- When the Child Lock function is activated, only the **Power** button works. The Child Lock function remains on even after the power is turned on and off or after disconnecting and reconnecting the power cord.

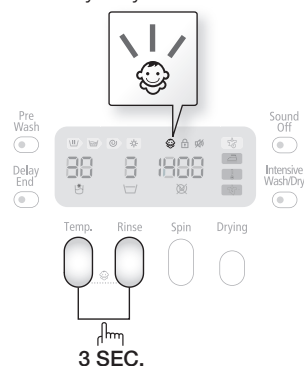

## Sound off

The Sound Off function can be selected during all courses. When this function is selected, sound is turned off for all courses. Even if the power is turned on and off repeatedly, the setting is retained.

### Activating/Deactivating

If you want to activate or deactivate the Sound Off function, press the **Sound Off** button. The lamp on the **Sound Off** button and the control panel will be lit when this feature is activated.

## Delay end

You can set the washing machine to finish your wash automatically at a later time, choosing a delay of between 3 to 19 hours (in 1 hour increments). The hour displayed indicates the time at which the wash will be finished.

1. Manually or automatically set your washing machine according to the type of laundry you are washing.
2. Press the **Delay End** button repeatedly until the delay time is set.
3. Press the **Start/Pause** button. The "Delay End" indicator will be lit, and the clock will begin counting down until it reaches the set time.
4. To cancel a Delay End function, press the **Power** button and then turn the washing machine on again.

## Drain Only Function

When you want just drain water from washing machine, follow directions below.

1. Press the **Power** button
2. Turn the Cycle Selector to the Spin position.
3. Press the **Spin** button 1 times until rpm sign is off.
4. Then "1" shows up on time display in center.
5. Press the **Start/Pause** button.



# washing a load of laundry

## Air Refresh

The Air Refresh system deodorizes and sterilizes fabrics without getting them wet, opening up cleaning options for many non washable items. The sterilization function also kills the common household dust mite, offering relief for allergy sufferers.

- **Air Washable items:** Cottons; Denims; Synthetics; Woollens – including coats, blankets, quilts, sweaters; suits; pillows; cushions; needlework; soft toys – such as teddy bears.
- **Non Air Washable items:** Leather, Silk, Velvet, Electric Blankets.



- This function will not remove stains from fabrics.
  - Suitable only for two or less items at a time (less than 1kg)
1. Open the door, place the laundry into the washing machine and close the door.
  2. Press the **Power** button.
  3. Select **Air Refresh** by turning the **Cycle Selector**.
    - Each time the button is pressed, the operating mode cycles through the following sequence: Deodorise, Sanitise ...

MODE	CYCLE TIME
Deodorise	29 min
Sanitise	59 min



- When one of these options has been selected, no other button can be selected and you can only select the delay end time from between 3:00 – 19:00.

4. Close the door and press the **Start/Pause** button.
  - When there is water in the tub, **Air Refresh** cannot be selected. Drain the water and select **Air Refresh**.
  - Press the **Start/Pause** or **Power** button to remove the laundry.
  - Fragrance or dryer sheets can be used with Air Refresh programs to add fragrance to your refreshed laundry (one sheet per one or two items).



- Avoid Air Refresh the following clothes:
- Sensitive clothes made of leather, mink, fur, silk, etc.
  - Underwear trimmed with lace, 'glued' doll cushions, and dress suits may have their decorations loosened.
  - Clothes trimmed with buttons can cause them to break.
  - Starchy clothes can become deformed.
  - Hard bedding such as a wooden pillows (neck-rest)
    - Pillows or blankets filled with plastic or starch rather than cotton
    - Electric blankets
  - Furry blankets
  - Bulky blankets
  - Latex pillow





## DRYING

Refer to the label of drying capacity and be sure to put in the clothes to the lower level than the marked line for the dried clothe of 4.0kg.

1. Open the door, put in the clothes and close the door again.
2. Press the **Power** button and then press the **Drying** button.  
: The standard course will be selected automatically.  
Drying is availably selected only at the courses Such as cotton, synthetics, denim and sports wear.
3. Select **Drying** button as follows.  
Drying Programs

- Every press of this button will select drying type repeatedly in the following order:  
Cup Board (☞) → Low Temp (⏴) → Iron (☞) → Time Dry (☞) (47min. → 1:17min. → 1:47min. → 2:17min. → 2:47min. → 3: 17min. → 3: 47min. → 4: 17min. → 4:47min.) → Cup Board
- ☞ • This combo allows you the choice of wash + dry or dry only options.
- The wash + dry course is available for the following wash courses only: Cotton, Intensive, Quick
- Before drying clothes, refer to the clothes label to ensure they are suitable for drying.
- The dryer is capable of drying up to 4kg's of clothes (ie weight of dry clothes). The drying function will not perform satisfactorily if this limit is exceeded.
- Auto dry and Time Dry drying options are available.
- The Auto Dry options (Cupboard, Low Temp. Iron) activate sensors that weigh the clothes and determine / set optimal drying time.
- The Time Dry option allows you to manually select the length of drying time. The drying time options are: (47min. → 1 :17min. → 1:47min. → 2:17min. → 2:47min. → 3: 17min. → 3: 47min. → 4: 17min. → 4:47min.)
- For laundry weighing less than 3.5kg, an Auto Dry course is recommended.
- When drying laundry that weighs between 3.5kg and 4kg the Time Dry option is recommended.
- The selected course can not be changed after the machine has started drying
- If you run a wash + dry course, the SPIN speed will automatically be set to High regardless of the wash course you have selected, in order to improve drying performance
- If cold water is not supplied to the machine, the drying function will not work. Please ensure the water valve is opened when using the drying function.
- If you want to dry after hand wash course press both Spin and Dry functions at the same time.
- The wrinkle prevention function is activated automatically if the clothes are not removed from the drum immediately after drying has ended. The wrinkle prevention function will run for 30 mins. with (End) on the display panel. To take the clothes out when this function is activated, press the Start/Pause or Power button to enable the door to open.

### Drying Time

Drying Type		Information	Max Load	Drying Time (Max Load)
Auto Drying	Cupboard (☞)	1. Rotate jog dial until Drying light illuminates 2. Press <b>Intensive Wash/dry</b> button	3.5 kg	177min.
	Cupboard	1. Rotate jog dial until Drying light illuminates 2. Press Intensive Wash button 3. Press <b>Start/Pause</b> button	3.5kg - 4.0kg	257min.
	Low Temp. (⏴)	1. Rotate jog dial until Drying light illuminates 2. Press Drying button until Low Temp. option illuminates 3. Press <b>Start/Pause</b> button	2.0kg	177min.
	Iron (☞)	1. Rotate jog dial until Drying light illuminates 2. Press Drying button until Iron option illuminates 3. Press <b>Start/Pause</b> button	2.0kg	47min.
<b>Time Drying (☞)</b>		1. Rotate the jog dial until Drying light illuminates 2. Press Drying button until Time Dry option illuminates 3. Continue to press Drying button until the drying time you require is illuminated 4. Press the <b>Start/Pause</b> button	4.0kg	287min.



appliancesonline.com.au

Australia's largest online appliance retailer  
washing a load of laundry \_23

# washing a load of laundry

## Wash + Dry

This is the cycle time for drying only, please refer to page 33 for the cycle wash time.

Drying Type		Information	Max Load	Drying Time (Max Load)
Auto / Sensor Drying	Cupboard (☼)	1. Place suitable amount of detergent and fabric softener in the detergent tray and close it again. 2. Rotate jog dial until your desired wash cycle is illuminated (cotton, synthetics, denim and sports wear) 3. Press <b>Start/Pause</b> button	3.5kg	177min.
	Cupboard	1. Place suitable amount of detergent and fabric softener in the detergent tray and close it again. 2. Rotate jog dial until your desired wash cycle is illuminated (cotton, synthetics, denim and sports wear) 3. Press <b>Intensive Wash/dry</b> button 4. Press <b>Start/Pause</b> button	3.5kg - 4.0kg	257min.
	Low Temp. (⋮)	1. Place suitable amount of detergent and fabric softener in the detergent tray and close it again. 2. Rotate jog dial until your desired wash cycle is illuminated (cotton, synthetics, denim and sports wear) 3. Press <b>Drying</b> button until Low Temp. option illuminates 4. Press <b>Start/Pause</b> button	2.0kg	177min.
	Iron (☼)	1. Place suitable amount of detergent and fabric softener in the detergent tray and close it again. 2. Rotate jog dial until your desired wash cycle is illuminated (cotton, synthetics, denim and sports wear) 3. Press <b>Drying</b> button until Iron option illuminates 4. Press <b>Start/Pause</b> button	2.0kg	47min.
Time Drying (☼)		1. Place suitable amount of detergent and fabric softener in the detergent tray and close it again. 2. Rotate the jog dial until your desired wash cycle is illuminated (cotton, synthetics, denim and sports wear) 3. Press <b>Drying</b> button until Time Dry option illuminates 4. Continue to press Drying button until the drying time you require is illuminated 5. Press the <b>Start/Pause</b> button	4.0kg	287min.

- It automatically displays Drying Time by sensing the weight of clothes before drying for increasing the drying effect.
  - If both the spin and drying cycles are selected, the spin speed is automatically selected to enhance the drying efficiency.
  - When using the drying cycle, check if the water supply valve is opened.  
When selecting the Drying function only, the Spin cycle is automatically performed first to enhance the drying efficiency.
4. Put suitable amount of detergent and fiber softener in the detergent tray and close it again.
  5. Press **Start/Pause** button.
- : It automatically performs an optimal function from washing to drying.
- The selected course can't be altered after the start of drying.
  - If you select Drying function, the intensity of SPIN will be set up as High in default for increasing the drying effect.
  - If cold water is not supplied, drying will not be performed.
  - If you do not take out clothes from the tub after the end of drying, a function of wrinkle protection will be performed for about 30 minutes with the display of [End]. In order to take out the clothes: press firstly Start/Pause or Power button and take them out.
  - In case you wish to dry after hand washing, select both Spin and Dry at the same time.

## Washing clothes using the cycle selector

Your new washing machine makes washing clothes easy, using Samsung's "Fuzzy Control" automatic control system. When you select a wash program, the machine will set the correct temperature, washing time, and washing speed.

1. Turn on your sink's water tap.
  2. Press the **Power** button.
  3. Open the door.
  4. Load the articles one at a time loosely into the drum, without overfilling it.
  5. Close the door.
  6. Add detergent, softener, and pre-wash detergent (if necessary) into the appropriate compartments.
-  Pre-wash is only available when selecting the Cotton, Synthetics, Denim, Sports Wear cycles. It is only necessary if your clothing is heavily soiled.
7. Use the **Cycle Selector** to select the appropriate cycle according to the type of material: Cotton, Synthetics, Denim, Sports Wear, Delicates, Wool, Hand Wash, Quick 29'. The relevant indicators will illuminate on the control panel.
  8. At this time, you can control the wash temperature, the amount of rinses, the spinning speed, and the delay time by pressing the appropriate option button.
  9. Press the **Start/Pause** button and the wash will begin. The process indicator will light up and the remaining time for the cycle will appear in the display.

### Pause Option

Within 5 minutes of starting a wash, it is possible to add/remove laundry items.

1. Press the **Start/Pause** button to unlock the door.
-  The door cannot be opened when the water is too HOT or the water level is too HIGH.
2. After closing the door, press the **Start/Pause** button to restart the wash.

### When the cycle is finished:

After the total cycle has finished, the power will turn off automatically.

1. Open the door.
2. Remove laundry.

## Washing clothes manually

You can wash clothes manually without using the Cycle Selector.

1. Turn the water supply on.
2. Press the **Power** button on the washing machine.
3. Open the door.
4. Load the articles loosely into the drum one at a time, without overfilling it.
5. Close the door.
6. Add detergent and, if necessary, softener or prewash detergent, into the appropriate compartments.
7. Press the **Temp.** button to select the temperature. (Cold water, 30 °C, 40 °C, 60 °C, 95 °C)
8. Press the **Rinse** button to select the required number of rinse cycles.  
The maximum number of rinse cycles is five.  
The wash duration is increased accordingly.
9. Press the **Spin** button to select the spin speed.  
The rinse hold function allows you to remove items that are still wet from the washing machine. (☒ : No Spin, ☐ : Rinse Hold)
10. Press the **Delay End** button repeatedly to cycle through the available Delay End options (from 3 hour to 19 hours in one hour increments). The hour displayed indicates the time at which the wash will be finished.
11. Press the **Start/Pause** button and the machine will begin the cycle.



# washing a load of laundry

## LAUNDRY GUIDELINES

Follow these simple guidelines for the cleanest laundry and the most efficient wash.

 Always check the Care label on clothing before washing.

### Sort and wash your laundry according to the following criteria:

- Care Label: Sort laundry into cottons, mixed fibres, synthetics, silks, wools and rayons.
- Colour: Divide whites and colours. Wash new colour items separately.
- Size: Placing items of different sizes in the same load will improve the wash action.
- Sensitivity: Wash delicate items separately, using the Delicate wash cycle for pure, new woollen items, curtains and silk articles. Check the labels on the items you are washing or refer to the fabric care chart in the appendix.

### Emptying pockets

Before each wash, empty all the pockets of your laundry. Small, irregularly shaped hard objects, such as coins, knives, pins, and paperclips could damage your washing machine. Do not wash clothing with large buckles, buttons, or other heavy metal objects.

Metal on clothing may damage your clothing as well as the tub. Turn clothing with buttons and embroidered clothes inside out before washing them. If zips of pants and jackets are open while washing, the spin basket may be damaged. Zips should be closed and fixed with a string before washing.

Clothing with long strings may become entangled with other clothes damaging them. Be sure to fix the strings before starting the wash.

### Prewashing cotton

Your new washing machine, combined with modern detergents, will give perfect washing results, thus saving energy, time, water and detergent. However, if your cotton is particularly dirty, prewash with a protein-based detergent.

### Determining the load capacity

Do not overload the washing machine or your laundry may not wash properly. Use the chart below to determine the load capacity for the type of laundry you are washing.

Fabric Type	Load Capacity
Model	WD8704/ WD8702
Cotton - average/lightly soiled - heavily soiled	7.5 kg
Synthetics	3.0 kg
Denim	3.0 kg
Sports Wear	2.5 kg
Delicates	2.5 kg
Wool	2.0 kg

-  • When the laundry is unbalanced (“UE” lights up on the display), redistribute the load. If the laundry is unbalanced, the spin efficiency may be degraded.
- When washing Bedding or Duvets, the wash time may be lengthened or the spin efficiency may be degraded.

**Make sure to insert brassieres (water washable) into a laundry net (to be purchased additionally).**

- The metal parts of the brassieres may break through the material and damage the laundry. Therefore make sure to place them inside a fine laundry net.
- Small, light clothing such as socks, gloves, stockings and handkerchiefs may become caught around the door. Place them inside a fine laundry net.

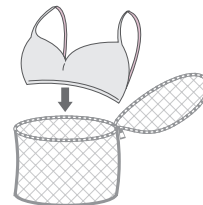

Do not wash the laundry net by itself without other laundry. This may cause abnormal vibrations that could move the washing machine and cause an accident resulting in injury.

## DETERGENT AND ADDITIVES INFORMATION

### Which detergent to use

The type of detergent you should use is based on the type of fabric (cotton, synthetic, delicate items, wool), colour, wash temperature, and degree of soiling. Always use "low suds" laundry detergent, which is designed for front load washing machines.

Follow the detergent manufacturer's recommendations based on the weight of the laundry, the degree of soiling, and the hardness of the water in your area. If you do not know how hard your water is, enquire at your local water authority.

To ensure maximum cleaning results, it is recommended that powdered detergent should be thoroughly dissolved in a small amount of water before adding to the machine.



Do not use detergent that has hardened or solidified as the detergent may remain in the rinse cycle. It may cause your washing machine to not rinse properly or result in the overflow becoming blocked.

**Please note the following when using the Wool course.**

- Use a neutral liquid detergent for wool only.
- When using a powder detergent, it may remain on the laundry and cause damage to the material (wool).

### Detergent drawer

Your washing machine has separate compartments for dispensing detergent and fabric softener. Add all laundry additives to the correct compartment before starting your washing machine.



Do NOT open the detergent drawer when your washing machine is running.

1. Pull out the detergent drawer on the left side of the control panel.
2. Add the recommended amount of laundry detergent directly into the detergent compartment ① before starting your washing machine.
3. Add the recommended amount of fabric softener into the softener compartment ② if required.
4. When using the Prewash option, add the recommended amount of laundry detergent into the prewash compartment ③.

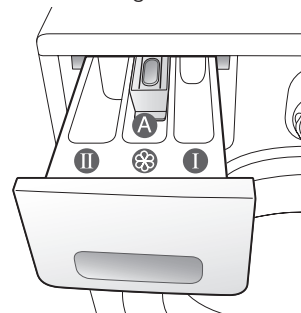

When washing large items do NOT use the following detergent types.

- Tablet and capsule type detergents
- Detergents using a ball and net



Concentrated or thick fabric softener and conditioner must be diluted with a little water before being poured into the dispenser (prevents the overflow from becoming blocked.)

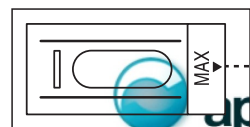
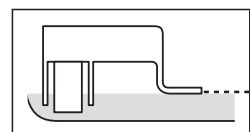

# cleaning and maintaining your washing machine

Keeping your washing machine clean improves its performance, wards off unnecessary repairs, and lengthens its life.

## DRAINING THE WASHING MACHINE IN AN EMERGENCY

1. Unplug the washing machine from the power supply.
2. Open the filter cover using a coin or a key.

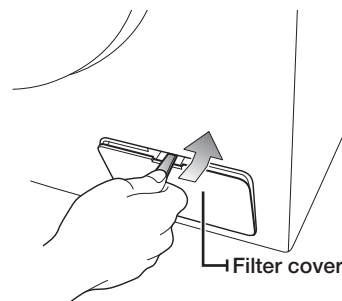

3. Unscrew the emergency drain cap by turning it to the left.

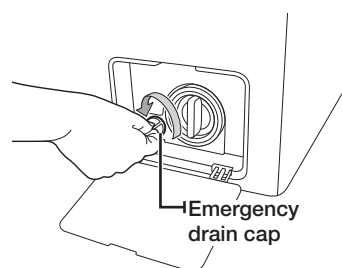

4. Hold the cap on the end of the emergency drain tube and slowly pull it out about 15 cm.
5. Allow all the water to flow into a bowl.
6. Reinsert the drain tube and screw the cap back on.
7. Replace the filter-cover.

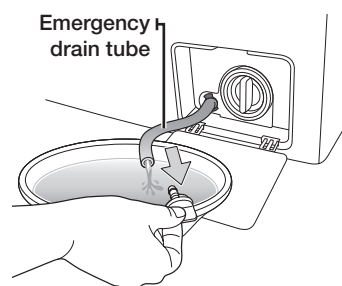

## CLEANING THE EXTERIOR

1. Wipe the washing machine surfaces, including the control panel, with a soft cloth using a nonabrasive household detergent.
2. Use a soft cloth to dry the surfaces.
3. Do not pour water onto the washing machine.

## CLEANING THE DETERGENT DRAWER AND DRAWER RECESS

1. Press the release lever on the inside of the detergent drawer and pull the drawer out.
2. Remove the liquid detergent divider from the detergent drawer

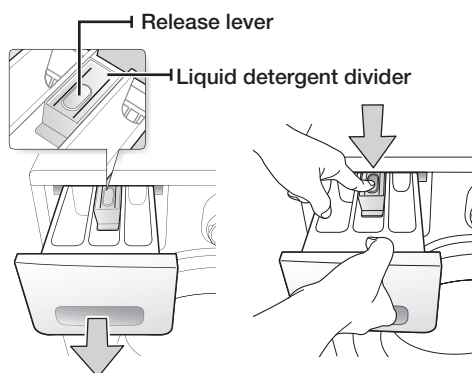

3. Wash all parts under running water.

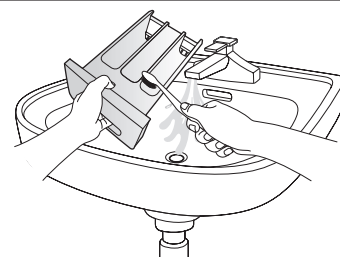

4. Clean the drawer recess with an old toothbrush.
5. Replace the liquid detergent divider by pushing it firmly into the drawer.
6. Push the drawer back into place.
7. To remove any remaining detergent, perform a rinse cycle without any laundry in the drum.

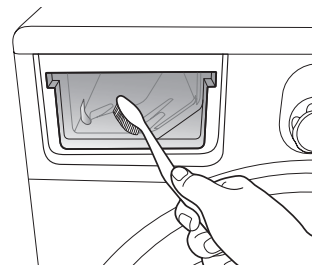

## CLEANING THE DEBRIS FILTER

We recommend cleaning the debris filter 5 or 6 times a year, or when the error message of "5E" is displayed. (Refer to "Draining the washing machine in an emergency" in the previous page.)

1. Open the filter cover by using a key or coin.
2. Unscrew the emergency drain cap by turning it to the left and drain off all the water.
3. Unscrew the debris filter cap.

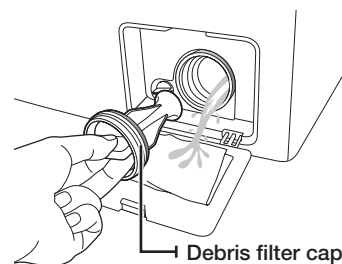

4. Wash any dirt or other material from the debris filter. Make sure the drain pump propeller behind the debris filter is not blocked.
5. Replace the debris filter cap.
6. Replace the filter cover.

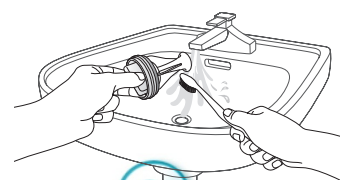

appliancesonline.com.au

Australia's largest online appliance retailer

cleaning and maintaining your washing machine 29



# cleaning and maintaining your washing machine

---

## CLEANING THE WATER HOSE MESH FILTER

---

You should clean the water hose mesh filter at least once a year, or when the error message of “4E” is displayed:

1. Turn off the water supply to the washing machine.
2. Unscrew the hose from the back of the washing machine. To prevent water from gushing out due to the air pressure in the hose, cover the hose with a cloth.
3. Gently pull out the mesh filter from the end of the hose using a pair of pliers and rinse it under water until clean. Also clean inside and outside the threaded connector.
4. Push the filter back into place.
5. Screw the hose back onto the washing machine.
6. Make sure the connections are watertight and turn on the tap.

## REPAIRING A FROZEN WASHING MACHINE

---

If the temperature drops below freezing and your washing machine is frozen:

1. Unplug the washing machine.
2. Pour warm water over the tap to loosen the water supply hose.
3. Remove the water supply hose and soak it in warm water.
4. Pour warm water into the washing machine drum and let it sit for 10 minutes.
5. Reconnect the water supply hose to the water tap and check if the water supply and drain are operating normal.

## STORING YOUR WASHING MACHINE

---

If you need to store your washing machine for an extended time, it's better to drain and disconnect it. Washing machines can be damaged if water is left in the hoses and internal components before storage.

1. Select the Quick 29' cycle and add bleach to the bleach compartment. Run your washing machine through the cycle without a load.
2. Turn the water taps off and disconnect the inlet hoses.
3. Unplug your washing machine from the electrical outlet, and leave your washing machine door open to allow air to circulate inside the tumbler.

 If your washing machine has been stored in below-freezing temperatures, allow time for any leftover water in your washing machine to thaw out before using it.

# troubleshooting and information codes

## CHECK THESE POINTS IF YOUR WASHING MACHINE...

PROBLEM	SOLUTION
Will not start	<ul style="list-style-type: none"><li>• Make sure your washing machine is plugged in.</li><li>• Make sure the door is firmly closed.</li><li>• Make sure the water source tap(s) are turned on.</li><li>• Make sure to press the Start/Pause button.</li></ul>
Has no water or not enough water	<ul style="list-style-type: none"><li>• Turn the water tap on fully.</li><li>• Make sure the water source hose is not frozen.</li><li>• Straighten the water intake hoses.</li><li>• Clean the filter on the water intake hose.</li></ul>
Has detergent remains in the detergent drawer after the wash cycle is complete	<ul style="list-style-type: none"><li>• Make sure your washing machine is running with sufficient water pressure.</li><li>• Make sure the detergent is added to the center of the detergent drawer.</li></ul>
Vibrates or is too noisy	<ul style="list-style-type: none"><li>• Make sure your washing machine is on a level surface. If the surface is not level, adjust the washing machine feet to level the appliance.</li><li>• Make sure that the shipping bolts are removed.</li><li>• Make sure your washing machine is not touching any other object.</li><li>• Make sure the laundry load is balanced.</li></ul>
The washing machine does not drain and/or spin	<ul style="list-style-type: none"><li>• Straighten the drain hose. Eliminate kinked hoses.</li><li>• Make sure the debris filter is not clogged.</li></ul>
Door is locked shut or will not open.	<ul style="list-style-type: none"><li>• The door will not open until 3 minutes after the machine stops or the power turns off.</li></ul>

If the problem persists, contact your local Samsung Customer Service.



# troubleshooting and information codes

## INFORMATION CODES

When your washing machine malfunctions, you may see an information code on the display. If that happens, check this table and try the suggested solution before calling Customer Service.

CODE SYMBOL	SOLUTION
<b>dE</b>	<ul style="list-style-type: none"><li>• Close the door.</li></ul>
<b>4E</b>	<ul style="list-style-type: none"><li>• Make sure the source water tap is turned on.</li><li>• Check the water pressure.</li></ul>
<b>5E</b>	<ul style="list-style-type: none"><li>• Clean the debris filter.</li><li>• Make sure the drainage hose is installed correctly.</li></ul>
<b>UE</b>	<ul style="list-style-type: none"><li>• The laundry load is unbalanced. Redistribute the load. If only one item of clothing needs washing, such as a bathrobe or pair of jeans, the final spin result might be unsatisfactory and an "UE" error message will be shown in the display window.</li></ul>
<b>cE/3E</b>	<ul style="list-style-type: none"><li>• Call the after-sales service.</li></ul>
<b>Hot</b>	<ul style="list-style-type: none"><li>• It appears when the internal temperature of the drum is high. The fan will automatically function, so just wait until "Hot" indication disappeared.</li></ul>

For any codes not listed above, or if the suggested solution doesn't fix the problem, call your Samsung Service Centre or local Samsung dealer.

# cycle chart

## CYCLE CHART

(● user option)

PROGRAM	Max load(kg)	DETERGENT			Max Temp (°C)
	WD8704/ WD8702	Pre-wash	wash	Softener	
Cotton	7.5	●	yes	●	95
Synthetics	3.0	●	yes	●	60
Denim	3.0	●	yes	●	60
Sports Wear	2.5	●	yes	●	60
Delicates	2.5	-	yes	-	40
Wool	2.0	-	yes	-	40
Handwash	2.0	-	yes	●	40
Deodorise	1.0	-	-	-	(not displayed)
Sanitise	1.0	-	-	-	(not displayed)
Drying	4.0	-	-	-	(not displayed)
Water Saving	7.5	●	yes	●	60
Quick 29'	3.0	-	yes	●	60

05 CYCLE CHART

PROGRAM	Spin Speed(MAX) rpm		Delay end	Cycle time (min)
	WD8704	WD8702		
Cotton	1400	1200	●	120
Synthetics	1200	1200	●	90
Denim	800	800	●	78
Sports Wear	1200	1200	●	72
Delicates	800	800	●	50
Wool	800	800	●	38
Handwash	400	400	●	31
Deodorise	-	-	●	29
Sanitise	-	-	●	59
Drying	-	-	●	257
Water Saving	1400	1200	●	199
Quick 29'	1400	1200	●	29





























1. A cycle with a prewash takes approx. 15 minutes longer.
2. The cycle duration data has been measured under the conditions specified in Standard IEC 60456 / EN 60456.
3. Course time in individual homes may differ from the values given in the table due to variations in the pressure and temperature of the water supply, the load and the type of laundry.
4. When the Intensive Wash function is selected, the cycle time is increased for each cycle.

# appendix

## FABRIC CARE CHART

The following symbols provide garment care directions. The care labels include four symbols in this order: washing, bleaching, drying and ironing, and dry cleaning when necessary.

The use of symbols ensures consistency among garment manufacturers of domestic and imported items. Follow the care label directions to maximize garment life and reduce laundering problems.

 Resistant material	 Can be ironed at 100 °C max
 Delicate fabric	 Do not iron
  Item may be washed at 95 °C	 Can be dry cleaned using any solvent
  Item may be washed at 60 °C	 Dry clean with perchloride, lighter fuel, pure alcohol or R113 only
  Item may be washed at 40 °C	 Dry clean with aviation fuel, pure alcohol or R113 only
  Item may be washed at 30 °C	 Do not dry clean
 Item may be hand washed	 Dry flat
 Dry clean only	 Can be hung to dry
 Can be bleached in cold water	 Dry on clothes hanger
 Do not bleach	 Tumble dry, normal heat
 Can be ironed at 200 °C max	 Tumble dry, reduced heat
 Can be ironed at 150 °C max	 Do not tumble dry

## PROTECTING THE ENVIRONMENT

- This appliance is manufactured from recyclable materials. If you decide to dispose of this appliance, please observe local waste disposal regulations. Cut off the power cord so that the appliance cannot be connected to a power source. Remove the door so that animals and small children cannot get trapped inside the appliance.
- Do not exceed the detergent quantities recommended in the detergent manufacturers' instructions.
- Use stain removal products and bleaches before the wash cycle only when strictly necessary.
- Save water and electricity by only washing full loads (the exact amount depends upon the program used).

## DECLARATION OF CONFORMITY

This appliance complies with European safety standards, EC directive 93/68 and EN Standard 60335.

## SPECIFICATIONS

TYPE		FRONT LOADING WASHING MACHINE	
DIMENSIONS	WD8704CJ/WD8704DJ/WD8704EJ/WD8704RJ WD8702CJ/WD8702DJ/WD8702EJ/WD8702RJ		
	W598mm X D600mm X H844mm		
WATER PRESSURE	50 kPa ~ 800 kPa		
WATER VOLUME	56 ℓ		
NET WEIGHT	WD8704CJ/ WD8704DJ/ WD8704EJ/ WD8704RJ	WD8702CJ/ WD8702DJ/ WD8702EJ/ WD8702RJ	
	70 kg	69 kg	
WASH AND SPIN CAPACITY	7.5 kg [DRY LAUNDRY]		
DRY CAPACITY	4.0 kg		
POWER CONSUMPTION	MODEL	WD8704CJ/WD8704DJ/WD8704EJ/WD8704RJ WD8702CJ/WD8702DJ/WD8702EJ/WD8702RJ	
	WASHING	220 V	150 W
		240 V	150 W
	WASH AND HEATING	220 V	2000 W
		240 V	2400 W
	DRYING	230V	1600W
	SPIN	MODEL	WD8704CJ/ WD8704DJ/ WD8704EJ/ WD8704RJ
230V		350 W	250 W
PUMPING	34 W		
PACKAGE WEIGHT	MODEL	WD8704CJ/WD8704DJ/WD8704EJ/WD8704RJ WD8702CJ/WD8702DJ/WD8702EJ/WD8702RJ	
	PAPER	2.5 kg	
	PLASTIC	2.5 kg	
SPIN REVOLUTIONS	MODEL	WD8704CJ/ WD8704DJ/ WD8704EJ/ WD8704RJ	WD8702CJ/ WD8702DJ/ WD8702EJ/ WD8702RJ
	rpm	1400	1200

The appearance and specifications of the product are subject to change without prior notice for purposes of product enhancement.



QUESTIONS OR COMMENTS?

Country	CALL	OR VISIT US ONLINE AT
AUSTRALIA	1300 362 603	<a href="http://www.samsung.com/au">www.samsung.com/au</a>



**appliancesonline**.co

Code No. DC68-02719A\_EN  
Australia's largest online appliance retailer

