



OWNER'S MANUAL

MICROWAVE OVEN

Please read this owner's manual thoroughly before operating.

MS3840SRSK

PRECAUTIONS

Precautions to avoid possible exposure to excessive microwave energy.

You cannot operate your oven with the door open due to the safety interlocks built into the door mechanism. These safety interlocks automatically switch off any cooking activity when the door is opened; which in the case of a microwave oven could result in harmful exposure to microwave energy.

It is important not to tamper with the safety interlocks.

Do not place any object between the oven front face and the door or allow food or cleaner residue to accumulate on sealing surfaces.

Do not operate your oven if it is damaged. It is particularly important that the oven door closes properly and that there is no damage to the: (1) door(bent), (2) hinges and latches (broken or loosened), (3) door seals and sealing surfaces.

Your oven should not be adjusted or repaired by anyone except qualified service personnel.

Warning

Please ensure cooking times are correctly set as over cooking may result in the FOOD catching fire and subsequent damage to your oven.

When heating liquids, e.g. soups, sauces and beverages in your microwave oven, overheating the liquid beyond boiling point can occur without evidence of bubbling. This could result in a sudden boil over of the hot liquid. To prevent this possibility the following steps should be taken:

1. Avoid using straight sided containers with narrow necks.
2. Do not overheat.
3. Stir the liquid before placing the container in the oven and again halfway through the heating time.
4. After heating, allow to stand in the oven for a short time, stir or shake them again carefully and check the temperature of them before consumption to avoid burns (especially, contents of feeding bottles and baby food jars).

Warning

Always allow food to stand after being cooked by microwaves and check the temperature of them before consumption. Especially contents of feeding bottles and baby food jars.

How the Microwave Oven Works

Microwaves are a form of energy similar to radio and television waves and ordinary daylight. Normally, microwaves spread outwards as they travel through the atmosphere and disappear without effect. Microwave ovens, however, have a magnetron which is designed to make use of the energy in microwaves. Electricity, supplied to the magnetron tube, is used to create microwave energy.

These microwaves enter the cooking area through openings inside the oven. A turntable or tray is located at the bottom of the oven. Microwaves cannot pass through metal walls of the oven, but they can penetrate such materials as glass, porcelain and paper, the materials out of which microwave-safe cooking dishes are constructed.

Microwaves do not heat cookware, though cooking vessels will eventually get hot from the heat generated by the food.

A very safe appliance

Your microwave oven is one of the safest of all home appliances. When the door is opened, the oven automatically stops producing microwaves. Microwave energy is converted completely to heat when it enters food, leaving no “left over” energy to harm you when you eat your food.

CONTENTS

PRECAUTIONS	2
CONTENTS	3
UNPACKING & INSTALLING	4
FEATURE DIAGRAM	6
CONTROL PANEL	6
OPERATING INSTRUCTIONS	7
SETTING CLOCK	7
MORE/LESS	7
QUICK START	7
TIMED COOKING	8
2 STAGE TIMED COOKING	8
MICROWAVE POWER LEVELS	8
CHILD LOCK	9
SENSOR COOK OPERATION INSTRUCTION	9
SENSOR COOK	9
SENSOR COOK MENU INSTRUCTIONS	10
SENSOR REHEAT	13
SENSOR REHEAT MENU INSTRUCTIONS	13
AUTO COOK	14
AUTO COOK MENU INSTRUCTIONS	15
AUTO REHEAT	18
AUTO REHEAT MENU INSTRUCTIONS	18
QUICK DEFROST	19
QUICK DEFROST MENU INSTRUCTIONS	19
KEEP MOISTURE	20
KEEP MOISTURE MENU INSTRUCTIONS	20
AUTO DEFROST	22
AUTO DEFROST MENU INSTRUCTIONS	23
COOKING TIPS	25
MICROWAVE-SAFE UTENSILS	29
FOOD CHARACTERISTICS & MICROWAVE COOKING	30
SAFETY PRECAUTIONS	32
QUESTION & ANSWERS	33
PLUG WIRING INFORMATION/TECHNICAL SPECIFICATIONS	34
MANUFACTURER'S WARRANTY	35

UNPACKING & INSTALLING

By following the basic steps on these two pages you will be able to quickly check that your oven is operating correctly. Please pay particular attention to the guidance on where to install your oven. When unpacking your oven make sure you remove all accessories and packing. Check to make sure that your oven has not been damaged during delivery.

- 1** Unpack your oven and place it on a flat level surface.

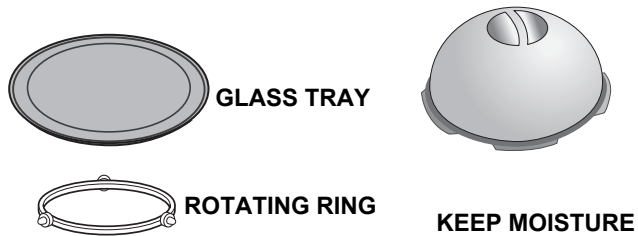
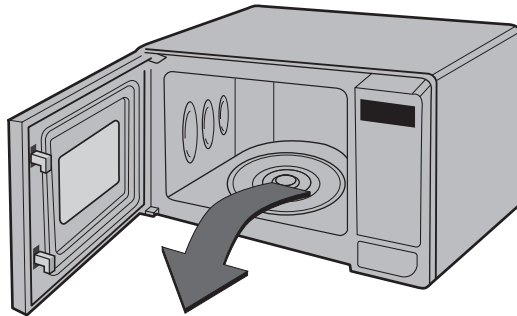

- 2** Place your oven on a flat, level surface but make sure there is at least **20 cm** of space on the top, rear and sides so there is air flow for ventilation. Exhaust outlets are located in the back and side of your oven. Blocking the outlets can damage your oven. The microwave oven shall not be placed in a cabinet.

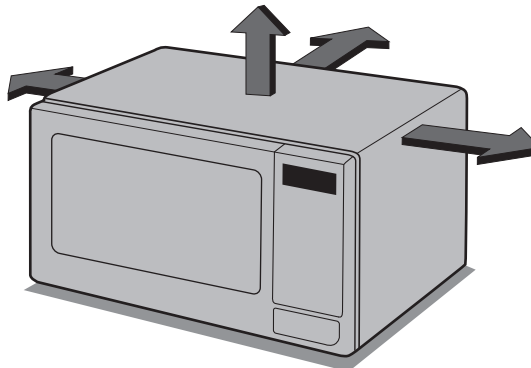

THIS OVEN SHOULD NOT BE USED FOR COMMERCIAL CATERING PURPOSES

UNPACKING & INSTALLING

- 3** Plug your oven into a standard household socket. Make sure your oven is the only appliance connected to the socket. **If your oven does not operate properly, unplug it from the electrical socket and then plug it back in.**

- 4** Open your oven door by pressing the **DOOR OPEN** button.
Place the **ROTATING RING** inside the oven and place the **GLASS TRAY** on top.

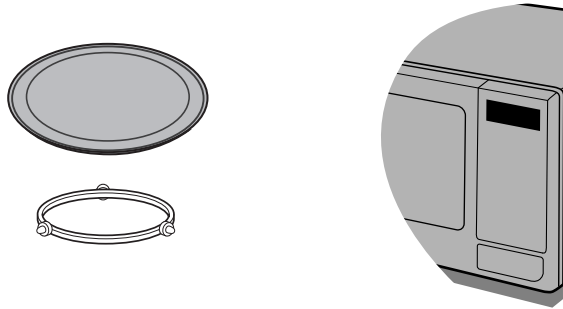

- 5** Fill a **microwave safe container** with 300 ml (1/2 pint) of water. Place on the **GLASS TRAY** and close the oven door. If you have any doubts about what type of container to use please refer to page 29.



- 6** Enter the time by touching [3] and [0].
And touch **START**.



- 7** The **DISPLAY** will count down from 30 seconds. When it reaches 0 it will sound BEEPS.
Open the oven door and test the temperature of the water. If your oven is operating the water should be **HOT**. **Be careful when removing the container it may be hot.**



YOUR OVEN IS NOW INSTALLED

FEATURE DIAGRAM

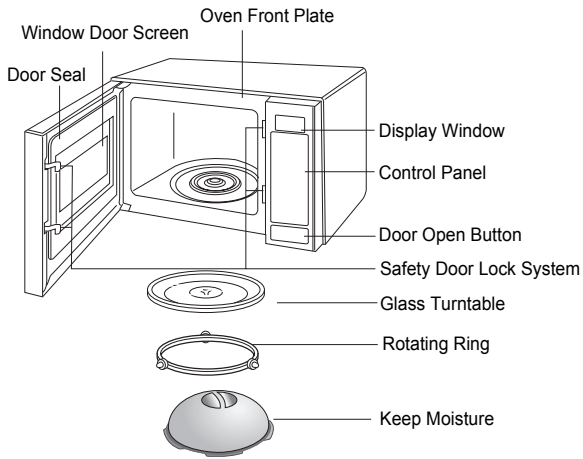

Remove your Microwave Oven and all material from the shipping carton. Your oven will be packed with the following materials:

- Glass Turntable 1 each
- Owner's Manual & Cooking Guide 1 each
- Rotating Ring 1 each
- Keep Moisture 1 each

This microwave oven is designed for household use only. It is not recommended for commercial purposes.

CONTROL PANEL

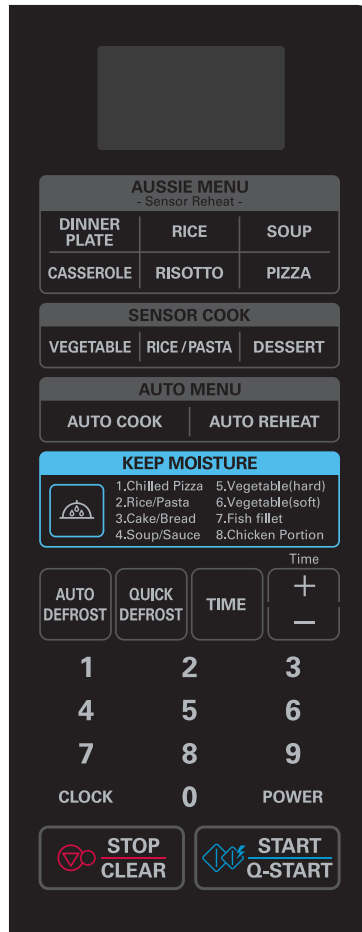

NOTE: A beep sounds when a pad on the control panel is touched to indicate setting has been entered.

OPERATING INSTRUCTIONS

SETTING CLOCK

When your oven is plugged in for the first time or when power resumes after a power interruption, the numbers in the display reset to "0".

Example: To set 11:11 .



1. Touch **STOP/CLEAR**.



2. Touch **CLOCK** one time.
'24H' will show in the display.



3. Touch **START**.



4. Enter the time by using the number key pads.
("11:11")



5. Touch **START**.
The clock starts counting.

NOTE :

If you want to use a 12 hour clock,
Press **CLOCK** once more.

If you want to change different option after setting clock, you have to unplug and plug it back in.

MORE/LESS

By using the (+) or (-) keys, KEEP MOISTURE AUTO COOK, AUTO REHEAT, TIMED COOK program can be adjusted to cook food for a longer or shorter time. Pressing (+) will add 10 seconds to the cooking time each time you press it. Pressing (-) will subtract 10 seconds of cooking time each time you press it. The max time could be 99min99sec.

To adjust the autocook (ex. Corned Beef 1.2 kg) cooking time for a longer time, or for a shorter time



1. Touch **STOP/CLEAR**.

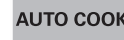

2. Touch **AUTO COOK**.
'Ac-1' will show in the display.



3. Touch **[1], [2]**.
("1.2kg")



4. Touch **START**.

NOTE: Press the (+) or (-) pad during time countdown.

QUICK START

The QUICK START feature allows you to set 30 seconds intervals of HIGH power cooking with a touch of the START/Q-START.

Example: Set 2 minutes of cooking on high power.

1.



Time of day.

2.



Four times

Select 2 minutes on high power.

You oven will start before you have finished the fourth press.

During QUICK START cooking, you can extend the cooking time up to 10 minutes by repeatedly pressing the START/Q-START key.

OPERATING INSTRUCTIONS (CONT'D)

TIMED COOKING

This function allows you to cook food for a desired time. And in order to give you the best results, there are 10 power level settings in addition to HI-POWER because many food need slower cooking (at less than HI-POWER).

1. Touch **STOP/CLEAR**.

2. Touch **TIME**.

3. Enter 5 minutes 30 seconds by touching **[5]**, **[3]**, and **[0]**.

4. Touch **POWER**. 'P-HI' appears in the display. This is to tell you that the oven is set on HI unless a different power setting is chosen.

5. Touch **8**. To select power level 80%. Display shows **P-80**.

6. Touch **START**.

MICROWAVE POWER LEVELS

Your microwave oven is equipped with eleven power levels to give you maximum flexibility and control over cooking. The table below will give you some idea of which foods are prepared at each of the various power levels.

* The chart below shows the power level settings for your oven.

MICROWAVE POWER LEVEL CHART

Power Level	Use
High (100%)	* Boiling water. * Browning ground beef. * Making candy. * Cooking poultry pieces, fish, & vegetables. * Cooking tender cuts of meat.
9	* Reheating rice, pasta, & vegetables.
8	* Reheating prepared foods quickly. * Reheating sandwiches.
7	* Cooking egg, milk and cheese dishes. * Cooking cakes, breads. * Melting chocolate.
6	* Cooking veal. * Cooking whole fish. * Cooking puddings and custard.
5	* Cooking ham, whole poultry, lamb. * Cooking rib roast, sirloin tip.
4	* Thawing meat, poultry and seafood.
3	* Cooking less tender cuts of meat. * Cooking pork chops, roast.
2	* Taking chill out of fruit. * Softening butter.
1	* Keeping casseroles and main dishes warm. * Softening butter and cream cheese.
0	* Standing time. * Independent timer.

When cooking is complete, four short tones will sound. The word **End** shows in the display window. Then the oven shuts itself off.

NOTE:

If you do not select the power level, the oven will operate at power HIGH. To set HI-POWER cooking, skip steps 4 & 5 above.

2 STAGE TIMED COOKING

For Two Stage cooking, repeat timed cooking steps 2 through 5 on the previous page before touching the START pad for additional Time and Power program you want to add.

Auto Weight Defrost can be programmed before the first stage to defrost first and then cook.

OPERATING INSTRUCTIONS (CONT'D)

CHILD LOCK

This is a unique safety feature that prevents unwanted oven operation such as used by children. Once the CHILD LOCK is set, no cooking can take place.

To set the child lock



1. Touch **STOP/CLEAR**.
2. Touch and hold **STOP/CLEAR** until L appears in the display and two beeps are heard. If the time of day was already set, the time of day will return to the display window. After you touch another cooking pad.



If the CHILD LOCK was already set and you touched another cooking pad, the word L shows in the display. Then you can cancel the CHILD LOCK according to below procedure.

To cancel the child lock



- Touch and hold **STOP/CLEAR** until L disappears in the display.

After the CHILD LOCK is turned off, the time of day will return to the display window. The oven will operate normally.

SENSOR COOK OPERATION INSTRUCTION

Sensor cooking provides exciting new features to make microwaving easier. Your new microwave oven will guide you, step by step, whether it be simply to reheat food or cook food.

and sensor menu with all the popular food choices helps you to cook perfectly because it has been pre-programmed and can tell how long to cook or reheat food items.

Categories:

Sensor Reheat

Sensor Cook

For most Sensor Cooking programs, a chart with specific food examples and cooking instructions is provided in the next new pages.

1. The Sensor Cook system works by detecting a build-up of vapor.
2. Make sure the door remains closed.
3. Once the vapor is detected, two beeps will sound.
4. Opening the door or touching the STOP/CLEAR pad before the vapor is detected will abort the process. The oven will stop.
5. Before using Sensor Touch, make sure the glass turntable is dry, to assure the best results.

SENSOR COOK

COOK allows you to cook most of your favorite foods without having to select cooking times and power levels. This oven automatically determines required cooking times for each food item. This feature has 15 food categories.

To cook VEGETABLES/JACKET POTATO



1. Touch **STOP/CLEAR**.



2. Touch **VEGETABLE** one time. 'S-F1' will show in the display.



3. Touch **START**. 'SENS' will show in the display. sensor cook starts.

OPERATING INSTRUCTIONS (CONT'D)

SENSOR COOK MENU INSTRUCTIONS - VEGETABLE

Code	Menu	Weight Limit	Initial Temperature	Instructions	Standing Time (minutes)																												
1	Jacket Potato Potatoes (whole)	1 - 4 pieces (175 g per piece)	Room	Wash & pat potatoes dry with paper towel. Pierce each potato 3 times with a fork. Place potatoes around the outer edge of the turntable. After cooking potatoes should still be firm. Wrap in foil and stand.	1 piece = 3 2 pieces = 5 3 pieces = 5 4 pieces = 7																												
2	Mashed Potato	2- 4 serves	Room	<table border="0"> <tr> <td>Ingredients</td> <td>2 serves</td> <td>3 serves</td> <td>4 serves</td> </tr> <tr> <td>Potato</td> <td>450 g</td> <td>675 g</td> <td>900 g</td> </tr> <tr> <td>Hot Milk</td> <td>1/2 cup</td> <td>2/3 cup</td> <td>3/4 cup</td> </tr> <tr> <td>Butter</td> <td>50 g</td> <td>75 g</td> <td>100 g</td> </tr> </table> <p>Salt 7 ground black pepper</p> <p>Peel potatoes and cut into 2cm cubes. Place the potato into a microwave- safe dish with 2 tablespoons of water. Place a sheet of damp paper towel directly onto the surface and cover the dish with lid or plastic wrap loosely. After cooking allow potatoes to stand. Drain. Mash the potatoes until smooth. Stir in hot milk and butter. Season with salt and pepper.</p>	Ingredients	2 serves	3 serves	4 serves	Potato	450 g	675 g	900 g	Hot Milk	1/2 cup	2/3 cup	3/4 cup	Butter	50 g	75 g	100 g	1 - 3												
Ingredients	2 serves	3 serves	4 serves																														
Potato	450 g	675 g	900 g																														
Hot Milk	1/2 cup	2/3 cup	3/4 cup																														
Butter	50 g	75 g	100 g																														
3	Fresh Vegetable Carrots, Broccoli, Cauliflower, Zucchini, Beans, Peas	0.2 - 0.8 kg	Room	Prepare vegetables. Cut vegetables into even size pieces. Wash the vegetables and arrange in microwave- safe dish just large enough to contain the vegetables so they are no more than 2 - 3 layers deep. Add amount of water according to the quantity (0.2kg~0.4kg : 2 tablespoons, 0.5kg~0.8kg : 4 tablespoons). Cover with lid or plastic wrap loosely. If cooking more than 1 kind of vegetable, place the harder vegetables around the outer edge of the dish with the softer vegetables in the centre,	3																												
4	Frozen Vegetable Carrots, Broccoli, Cauliflower, Beans, Peas	0.2 - 0.8 kg	Frozen	Separate the vegetables into single pieces. Arrange the vegetables in a microwave- safe dish just large enough to contain them so they are no more than 2 layers deep. Add amount of water according to the quantity (0.2kg~0.4kg : 2 tablespoons, 0.5kg~0.8kg : 4 tablespoons). Cover with lid or plastic wrap loosely. If cooking more than 1 kind of vegetable, place the harder vegetables around the outer edge of the dish with the softer vegetables in the centre.	3																												
5	Fresh Soup	2 - 6 serves	Room	<p>Pumpkin Soup</p> <table border="1"> <thead> <tr> <th>Ingredients</th> <th colspan="3">Serves</th> </tr> <tr> <th></th> <th>2 serves</th> <th>4 serves</th> <th>6 serves</th> </tr> </thead> <tbody> <tr> <td>Pumpkin</td> <td>500 g</td> <td>750 g</td> <td>1 kg</td> </tr> <tr> <td>Brown onion</td> <td>1/2 small</td> <td>1 small</td> <td>1 medium</td> </tr> <tr> <td>Chicken stock</td> <td>2 cups</td> <td>3 cups</td> <td>4 cups</td> </tr> <tr> <td>Cream 2</td> <td>tbs</td> <td>1/4 tbs</td> <td>1/3 tbs</td> </tr> <tr> <td>Ground nutmeg, Salt & ground black pepper</td> <td colspan="3">To taste</td> </tr> </tbody> </table> <p>Peel & remove the seeds from the pumpkin. Finely chop the onion. Place the pumpkin, onion and stock into a heatproof, microwave- safe bowl. Cover with lid or two layers of plastic wrap loosely. After cooking, blend or process to desired consistency. Stir in cream, nutmeg and season with salt and pepper.</p> <p>For potato leek soup, replace the pumpkin with desire potatoes & replace the onion with leek.</p> <p>For carrot & sweet potato soup, replace the pumpkin with equal quantities of carrot and sweet potato. Omit the cream. Replace the nutmeg with ground cumin.</p>	Ingredients	Serves				2 serves	4 serves	6 serves	Pumpkin	500 g	750 g	1 kg	Brown onion	1/2 small	1 small	1 medium	Chicken stock	2 cups	3 cups	4 cups	Cream 2	tbs	1/4 tbs	1/3 tbs	Ground nutmeg, Salt & ground black pepper	To taste			-
Ingredients	Serves																																
	2 serves	4 serves	6 serves																														
Pumpkin	500 g	750 g	1 kg																														
Brown onion	1/2 small	1 small	1 medium																														
Chicken stock	2 cups	3 cups	4 cups																														
Cream 2	tbs	1/4 tbs	1/3 tbs																														
Ground nutmeg, Salt & ground black pepper	To taste																																

OPERATING INSTRUCTIONS (CONT'D)

SENSOR COOK MENU INSTRUCTIONS - RICE / PASTA

Code	Menu	Weight Limit	Initial Temperature	Instructions	Standing Time (minutes)															
1	White Rice	1/2 - 2 cups	Rice : Room Water : Room	<table border="1"> <tr> <td>Rice</td> <td>1/2 cup</td> <td>1 cup</td> <td>1 1/2 cups</td> <td>2 cups</td> </tr> <tr> <td>Tap water</td> <td>3/4 cup</td> <td>1 1/4 cups</td> <td>2 cups</td> <td>2 1/2 cups</td> </tr> </table> <p>Wash the rice under cold water until the water runs clear. Place the rice and water in a microwave-safe rice cooker or 3-litre bowl. Cover with lid or double layer of plastic wrap loosely. After cooking allow the rice to stand without removing the lid or wrap. After standing stir with a fork to separate the grains. Replace the water with stock for more flavour.</p>	Rice	1/2 cup	1 cup	1 1/2 cups	2 cups	Tap water	3/4 cup	1 1/4 cups	2 cups	2 1/2 cups	3 - 5					
				Rice	1/2 cup	1 cup	1 1/2 cups	2 cups												
Tap water	3/4 cup	1 1/4 cups	2 cups	2 1/2 cups																
<p>Place the rice and water in a microwave-safe rice cooker or 3-litre bowl. Cover with lid or double layer of plastic wrap loosely. After cooking allow the rice to stand without removing the lid or wrap. After standing stir with a fork to separate the grains. Replace the water with stock for more flavour.</p>																				
2	Porridge	1 - 4 serves	Oats : Room Milk : Cold	<table border="1"> <tr> <td></td> <td>1 serve</td> <td>2 serves</td> <td>3 serves</td> <td>4 serves</td> </tr> <tr> <td>Oats</td> <td>1/2 cup</td> <td>2/3 cup</td> <td>1 cup</td> <td>1 1/3 cups</td> </tr> <tr> <td>Cold Milk</td> <td>3/4 cup</td> <td>1 1/2 cups</td> <td>2 1/4 cups</td> <td>3 cups</td> </tr> </table> <p>Place the oats and milk in a deep 3-litre heatproof microwave-safe bowl. Cook uncovered. The oven will beep, stir the oats well and press start to continue. After cooking, stir well and top with brown sugar or honey.</p>		1 serve	2 serves	3 serves	4 serves	Oats	1/2 cup	2/3 cup	1 cup	1 1/3 cups	Cold Milk	3/4 cup	1 1/2 cups	2 1/4 cups	3 cups	1 - 3
					1 serve	2 serves	3 serves	4 serves												
Oats	1/2 cup	2/3 cup	1 cup	1 1/3 cups																
Cold Milk	3/4 cup	1 1/2 cups	2 1/4 cups	3 cups																
<p>Place the oats and milk in a deep 3-litre heatproof microwave-safe bowl. Cook uncovered. The oven will beep, stir the oats well and press start to continue. After cooking, stir well and top with brown sugar or honey.</p>																				
3	Dry Pasta	1 - 4 cups	Water : hot tap water (60°C)	<p>Place into a microwave-safe large bowl. Pour hot tap water into a bowl. Cooked uncovered. The oven will beep, stir well and press start to continue. After cooking, stand and stir.</p> <table border="1"> <tr> <td>Pasta</td> <td>1 cup</td> <td>2 cups</td> <td>3 cups</td> <td>4 cups</td> </tr> <tr> <td>Hot tap water(60°C) (1 cup=250 ml)</td> <td>2 1/3 cup</td> <td>4 cups</td> <td>5 cups</td> <td>6 cups</td> </tr> </table>	Pasta	1 cup	2 cups	3 cups	4 cups	Hot tap water(60°C) (1 cup=250 ml)	2 1/3 cup	4 cups	5 cups	6 cups	2 - 4					
				Pasta	1 cup	2 cups	3 cups	4 cups												
Hot tap water(60°C) (1 cup=250 ml)	2 1/3 cup	4 cups	5 cups	6 cups																
<p>Place into a microwave-safe large bowl. Pour hot tap water into a bowl. Cooked uncovered. The oven will beep, stir well and press start to continue. After cooking, stand and stir.</p>																				
4	Fresh Pasta Tortellini Ravioli Fettuccine	1 - 4 cups	Water : hot tap water (60°C)	<p>Place into a microwave-safe large bowl. Pour hot tap water into a bowl. Cooked uncovered. The oven will beep, stir well and press start to continue. After cooking, stand and stir.</p> <table border="1"> <tr> <td>Pasta</td> <td>1 cup</td> <td>2 cups</td> <td>3 cups</td> <td>4 cups</td> </tr> <tr> <td>Hot tap water(60°C) (1 cup=250 ml)</td> <td>2 1/3 cup</td> <td>4 cups</td> <td>5 cups</td> <td>6 cups</td> </tr> </table>	Pasta	1 cup	2 cups	3 cups	4 cups	Hot tap water(60°C) (1 cup=250 ml)	2 1/3 cup	4 cups	5 cups	6 cups	2 - 4					
				Pasta	1 cup	2 cups	3 cups	4 cups												
Hot tap water(60°C) (1 cup=250 ml)	2 1/3 cup	4 cups	5 cups	6 cups																
<p>Place into a microwave-safe large bowl. Pour hot tap water into a bowl. Cooked uncovered. The oven will beep, stir well and press start to continue. After cooking, stand and stir.</p>																				
5	Frozen Pasta Tortellini Ravioli	1 - 4 cups	Water : hot tap water (60°C)	<p>Place into a microwave-safe large bowl. Pour hot tap water into a bowl. Cooked uncovered. The oven will beep, stir well and press start to continue. After cooking, stand and stir.</p> <table border="1"> <tr> <td>Pasta</td> <td>1 cup</td> <td>2 cups</td> <td>3 cups</td> <td>4 cups</td> </tr> <tr> <td>Hot tap water(60°C) (1 cup=250 ml)</td> <td>2 1/3 cup</td> <td>4 cups</td> <td>5 cups</td> <td>6 cups</td> </tr> </table>	Pasta	1 cup	2 cups	3 cups	4 cups	Hot tap water(60°C) (1 cup=250 ml)	2 1/3 cup	4 cups	5 cups	6 cups	2 - 4					
				Pasta	1 cup	2 cups	3 cups	4 cups												
Hot tap water(60°C) (1 cup=250 ml)	2 1/3 cup	4 cups	5 cups	6 cups																
<p>Place into a microwave-safe large bowl. Pour hot tap water into a bowl. Cooked uncovered. The oven will beep, stir well and press start to continue. After cooking, stand and stir.</p>																				
6	Instant Noodle (1 packet= approx. 85g)	1 packet	Water : boiling water	<p>Place unpackaged noodles into a large microwave-safe bowl. Cook uncovered. When the Oven beeps, the noodles should be stirred well, before pressing Start to continue the remaining cooking time. After cooking has finished, briefly stand and stir before serving.</p> <table border="1"> <tr> <td>Noodles</td> <td>1 packet</td> </tr> <tr> <td>Boiling water (1 cup=250 ml)</td> <td>2 cups</td> </tr> </table>	Noodles	1 packet	Boiling water (1 cup=250 ml)	2 cups	1 - 2											
				Noodles	1 packet															
Boiling water (1 cup=250 ml)	2 cups																			
<p>Place unpackaged noodles into a large microwave-safe bowl. Cook uncovered. When the Oven beeps, the noodles should be stirred well, before pressing Start to continue the remaining cooking time. After cooking has finished, briefly stand and stir before serving.</p>																				

OPERATING INSTRUCTIONS (CONT'D)

SENSOR COOK MENU INSTRUCTIONS - DESSERT

Code	Menu	Weight Limit	Initial Temperature	Instructions	Standing Time (minutes)
1	Cake Packet Cake Mix	1 packet	Room	Prepare the cake following the microwave instructions on the side of the packet, ignoring the cooking instructions. Place the cake, uncovered, onto a microwave- safe rack or upturned plate about 2cm off the turntable. At the end of the cooking time, remove the cake from the microwave oven, cover with a plate or piece of foil and stand for 5 minutes or until the sticky centre portion is completely cooked.	5
2	Brownies	About 10 brownies	Room	<p>100g butter 100g soft brown sugar 25g cocoa, sifted 50g self- raising flour, sifted 1 egg 1 table spoon milk 25g walnuts, finely chopped</p> <p>Icing 100g plain chocolate 1 table spoon black coffee walnut halves to decorate</p> <ol style="list-style-type: none"> Place the butter in a basin and melt on full for about 1- 1½ minutes. Mix together the sugar, cocoa and flour. Beat together the egg and milk. Stir into the flour mixture, together with the butter, walnuts and raisins. Spread in a greased and base- lined shallow dish measuring 18 x 28cm / 7 x 11 in. Cook uncovered. At the end of the cooking time, remove the brownies from the microwave. Stand or until cooled. For the icing, place the chocolate and coffee in a basin and cook on full for 3- 4 minutes. Spread the icing over the cake. When almost set cut the brownies into squares and top each portion with a piece of walnut. 	10
3	Pudding Self- saucing sponge pudding 1 packet = 250- 260g	1 packet	Room	Prepare the pudding following the microwave instructions on the side of the packet, ignoring the cooking instructions. Spoon the pudding batter into an 8- cup (2 litre) heatproof, microwave- safe bowl. Top with the sauce mix and boiling water. Place the cake, uncovered, onto a microwave- safe rack or upturned plate about 2cm off the turntable. At the end of the cooking time, remove the pudding from the microwave oven, cover with a plate or piece of foil and stand for 5 minutes or until the sticky centre portion is completely cooked.	5
4	Stewed Fruit	0.2 - 1.0 kg	Room	Peel core and roughly chop the fruit. Sprinkle the fruit with 2- 4 tsp caster sugar. Cover with a lid or plastic wrap. At the end of the cooking time, allow to stand.	1 - 3

OPERATING INSTRUCTIONS (CONT'D)

SENSOR REHEAT

To reheat DINNER PLATE



**STOP
CLEAR**

1. Touch **STOP/CLEAR**.



**DINNER
PLATE**

2. Touch **DINNER PLATE** pad. 'SENS' will show in the display.

Then the oven will reheat food automatically by sensor system.

This feature allows you to reheat precooked room-temperature or refrigerated foods without selecting cooking times and power levels. This feature has 6 categories : dinner plate, rice, soup, casserole, risotto, pizza.

SENSOR REHEAT MENU INSTRUCTIONS

Code	Menu	Weight Limit	Initial Temperature	Instructions	Standing Time (minutes)	
1	Dinner Plate	1 serve	Refrigerated	1 serve	Arrange the food on a microwave- safe plate. Cover loosely with plastic wrap. After reheating, allow to stand.	
				Meat or chicken		125 g
				Mashed potato		200 g
				Vegetable, cooked		200 g
2	Rice	1- 4 cups	Room	Place the cooked rice into a microwave- safe, heatproof dish. Cover with a lid or double layer of plastic wrap loosely. After reheating stir well before serving.	1	
				Note : If reheating rice from the fridge add extra 2- 6 minutes (depending on serving size) on 50% power .		
3	Soup	1- 4 cups (1 cup= 250 ml)	Room	When reheating 1 or 2 serves soup place into individual microwave- safe cups or bowls and cover with plastic wrap loosely. When reheating 3- 4 serves of soup place into 1 large heatproof, microwave- safe bowl. Cover loosely with two layers of plastic wrap. After heating stir well before serving. Note : If reheating soup from the fridge add extra 2- 5 minutes (depending on serving size) on 70% power .	1 - 2	
4	Casserole	1- 4 cups	Room	Place the casserole into a microwave- safe, heatproof dish. Cover with a lid or double layer of plastic wrap loosely. After reheating stir well before serving. Note : If reheating casserole from the fridge add extra 2- 6 minutes (depending on serving size) on 50% power .	2 - 3	

OPERATING INSTRUCTIONS (CONT'D)

SENSOR REHEAT MENU INSTRUCTIONS

Code	Menu	Weight Limit	Initial Temperature	Instructions	Standing Time (minutes)
5	Risotto	1- 4 cups	Room	Place the cooked risotto into a microwave- safe, heatproof dish.Cover with a lid or double layer of plastic wrap loosely.After reheating stir well before serving. Note : If reheating risotto from the fridge add extra 2- 6 minutes (depending on serving size) on 50% power.	1
6	Pizza (1 piece= 100 - 120 g)	1 - 4 pieces	Refrigerated	Place pizza onto a sheet of non- recycled paper towel directly on the turntable. Reheat uncovered. Note: The weight and thickness of pizza varies considerably, if pizza is not hot enough add extra time on 50% power.	



AUTO COOK

This feature allows to cook foods that you select by touching AUTO COOK pad. It has 8 foods categories.



To cook four slices of Roast Lamb.





1. Touch **STOP/CLEAR.**

2. Touch **AUTO COOK** three times
'Ac-3' will shows in the display.

3. Touch number [1], [2].
("1 .2kg ")

4. Touch **START.**

OPERATING INSTRUCTIONS (CONT'D)

AUTO COOK MENU INSTRUCTIONS

Code	Menu	Weight Limit	Initial Temperature	Instructions	Standing Time (minutes)																																
1	Corned Beef	1.0 - 2.0 kg	Refrigerated	<table border="0"> <tr> <td>Corned beef</td> <td>1 kg</td> <td>1.5 kg</td> <td>2 kg</td> </tr> <tr> <td>Warm water</td> <td>3 cups</td> <td>4 cups</td> <td>6 cups</td> </tr> <tr> <td>Brown sugar</td> <td>2 tbs</td> <td>3 tbs</td> <td>3 tbs</td> </tr> <tr> <td>Malt vinegar</td> <td>2 tbs</td> <td>3 tbs</td> <td>4 tbs</td> </tr> <tr> <td>Whole cloves</td> <td>4</td> <td>5</td> <td>6</td> </tr> <tr> <td>Peppercorns</td> <td>6</td> <td>8</td> <td>10</td> </tr> <tr> <td>Dry bay leaves</td> <td>2</td> <td>3</td> <td>3</td> </tr> <tr> <td>Sprigs fresh parsley</td> <td>3</td> <td>4</td> <td>5</td> </tr> </table> <p>Place the corned silverside into an oven bag with ingredients shown above. Place the bag into a deep heatproof, microwave- safe bowl. Halfway through the oven will beep and display turn food over. Remove the dish from the microwave oven, carefully turn the beef over. Press start to continue cooking. At the end of the cooking time allow beef to stand 15 - 20 minutes before serving.</p>	Corned beef	1 kg	1.5 kg	2 kg	Warm water	3 cups	4 cups	6 cups	Brown sugar	2 tbs	3 tbs	3 tbs	Malt vinegar	2 tbs	3 tbs	4 tbs	Whole cloves	4	5	6	Peppercorns	6	8	10	Dry bay leaves	2	3	3	Sprigs fresh parsley	3	4	5	15 - 20
Corned beef	1 kg	1.5 kg	2 kg																																		
Warm water	3 cups	4 cups	6 cups																																		
Brown sugar	2 tbs	3 tbs	3 tbs																																		
Malt vinegar	2 tbs	3 tbs	4 tbs																																		
Whole cloves	4	5	6																																		
Peppercorns	6	8	10																																		
Dry bay leaves	2	3	3																																		
Sprigs fresh parsley	3	4	5																																		
2	Seasoned Meat	1.0 - 2.0 kg	Refrigerated	<p><u>Fruity Beef</u></p> <table border="0"> <tr> <td><u>Sauce</u></td> <td><u>Seasoning</u></td> </tr> <tr> <td>topside beef</td> <td>1½ cups stuffing mix</td> </tr> <tr> <td>125 ml fruit chutney</td> <td>Water to mix</td> </tr> <tr> <td>1 tbs oil</td> <td></td> </tr> <tr> <td>1 tbs Worcestershire Sauce</td> <td></td> </tr> <tr> <td>1 tbs curry powder</td> <td></td> </tr> <tr> <td>2 tbs mustard powder</td> <td></td> </tr> <tr> <td>1 tbs sweet sherry</td> <td></td> </tr> </table> <p>Prepare beef to be seasoned by cutting a pocket in the centre. Mix sauce ingredients together and put to one side. Prepare enough seasoning by following instructions on the packet. Place loosely into prepared packet. Tie meat with string. Brush sauce over meat. Place the meat on a small roasting rack fat side down in a deep heatproof, microwave- safe bowl. Halfway through the oven will beep and display turn food over. Remove the dish from the microwave, carefully turn the beef over. Press start to continue cooking. At the end of the cooking time loosely cover the meat with foil and allow to stand 15 - 20 minutes before serving.</p>	<u>Sauce</u>	<u>Seasoning</u>	topside beef	1½ cups stuffing mix	125 ml fruit chutney	Water to mix	1 tbs oil		1 tbs Worcestershire Sauce		1 tbs curry powder		2 tbs mustard powder		1 tbs sweet sherry		15 - 20																
		<u>Sauce</u>	<u>Seasoning</u>																																		
topside beef	1½ cups stuffing mix																																				
125 ml fruit chutney	Water to mix																																				
1 tbs oil																																					
1 tbs Worcestershire Sauce																																					
1 tbs curry powder																																					
2 tbs mustard powder																																					
1 tbs sweet sherry																																					
		1.0 - 2.0 kg	Refrigerated	<p><u>Apple and Sage Pork</u></p> <p><u>Seasoning</u></p> <p>Boned loin pork (with rind on) 1- 2 cups sage and onion stuffing mix ½ cup dried apples, chopped 8 - 10 prunes, pitted and chopped 125 g toasted silvered almonds</p> <p>Following instructions on the packet prepare stuffing. Add apples, prunes and almonds. Mix well. Pack loosely down the centre of meat. Roll up tightly and secure with string. Sprinkle rind with salt. Place the meat on a small roasting rack fat side down in a deep heatproof, microwave- safe bowl. Halfway through the oven will beep and display turn over. Remove the dish from the microwave oven, carefully turn the meat over. Press start to continue cooking. At the end of the cooking time loosely cover the meat with foil and allow to stand 15- 20 minutes before serving.</p>	15 - 20																																

OPERATING INSTRUCTIONS (CONT'D)

AUTO COOK MENU INSTRUCTIONS

Code	Menu	Weight Limit	Initial Temperature	Instructions	Standing Time (minutes)
2	Seasoned Meat	1.0 - 2.0 kg	Refrigerated	<p>Apricot Lamb</p> <p>Loin of forequarter lamb (deboned) 1 packet dried apricots 250 ml apricot nectar 1 tbs cornflour</p> <p>Unroll meat. Place dried apricots down the centre 2 rows deep. Roll up tightly and secure with string. Mix apricot nectar with corn flour and heat for 3 - 4 minutes on HIGH or until boil. Allow to cool slightly. Pour apricot juice over the meat and marinade 1 - 2 hours. Remove meat from the marinade, place the meat on a small roasting rack fat side down in a deep heatproof, microwave- safe bowl. Halfway through the oven will beep and display turn food over. Remove the dish from the microwave oven, carefully turn the meat over. Press start to continue cooking. At the end of the cooking time loosely cover the meat with foil and allow to stand 15 - 20 minutes before serving.</p>	15 - 20
3	Roast Lamb	1.0 - 2.0 kg	Refrigerated	<p>Brush both sides of the lamb with olive oil and season with salt and pepper. Shield the knuckle with foil, making sure the foil is secure & will not touch the interior oven walls when rotating. Place the lamb skin-side side down onto a microwave- safe roasting rack or upturned plate. Halfway through cooking the oven will beep and display turn food over. Remove the lamb from the microwave oven, turn the lamb over and remove the foil from the knuckle. Press start to continue cooking. At the end of the cooking time loosely cover the lamb with foil and allow to stand or place the lamb into a preheated oven 200°C for 5 - 10 mins to crispen the surface. Allow to stand 15 - 20 minutes before serving</p>	15 - 20
4	Roast Chicken	1.0 - 2.5 kg	Refrigerated	<p>Wash and pat the chicken dry with paper towel. Brush both sides of the chicken with olive oil and season with salt and pepper. Tie the legs together with string. Shield the legs and wings with foil. Place chicken breast side down onto a microwave- safe roasting rack or upturned plate. Halfway through the oven will beep and display turn food over. Remove the chicken from the microwave oven, turn the chicken over and remove the foil from legs and wings. Press start to continue cooking. At the end of the cooking time, place the chicken into a preheated oven 200°C for 5- 10 mins to crispen the skin. Allow to stand 10 minutes before serving.</p>	10
5	Chicken Pieces (thigh or cutlets)	0.2 - 0.8 kg	Refrigerated	<p>Brush the chicken pieces with olive oil and season with salt and pepper. Place chicken skin side up onto a microwave- safe roasting rack. At the end of cooking, remove the chicken from the microwave and allow to stand 2- 3 minutes or place into a preheated oven 200°C for 5 - 10 minutes to crispen the skin</p>	2 - 3

OPERATING INSTRUCTIONS (CONT'D)

AUTO REHEAT

Your oven's menu has been preprogrammed to automatically reheat food. Tell the oven what you want and how many items there are. Then let your microwave oven reheat your selections.

Be sure to close the door before selecting categories.

Example: To reheat two pies of pie, simply follow the step below.



1. Touch **STOP/CLEAR**.

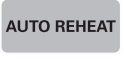

2. Touch **AUTO REHEAT** one time. 'rh-1' will shows in the display.



3. Touch **2**. '2' will shows in the display.



4. Touch **START**.

AUTO REHEAT MENU INSTRUCTIONS

Code	Menu	Weight Limit	Initial Temperature	Instructions	Standing Time (minutes)
1	Pie (meat pie, 1 pie = 190g)	1 - 4 pies	Room	Place pie(s) between two sheets of non recycled paper towel on a microwave- safe plate. Note: If reheating pies from the fridge add extra 2- 6 minutes (depending on serving size) on 50% power .	1
2	Beverage (1 cup = 250 ml)	1 - 4 cups	Room	Make sure the cup is microwave- safe. Place a wooden skewer or paddle pop stick into each cup to break the beverage surface. Heat uncovered. After heating stir well before serving.	
3	Frozen Muffin (1 muffin = 75 - 80 g)	1 - 4 muffins	Frozen	Space the muffins evenly around the outer edge of the microwave turntable.	
4	Fresh Muffin (1 muffin = 75 - 80 g)	1 - 4 muffins	Room	Space the muffins evenly around the outer edge of the microwave turntable.	

OPERATING INSTRUCTIONS (CONT'D)

QUICK DEFROST

Example: To defrost 0.5 kg meat.



1. Touch **STOP/CLEAR**.

2. Touch **QUICK DEFROST**.

Three Quick Defrost sequences are preset in the oven. The Quick Defrost feature provides you with the express defrosting method for 500g frozen foods. The oven automatically sets the defrosting time for each food.

NOTE:

The oven will beep during the DEFROST CYCLE. At this time open the door and turn over, separate, or rearrange the food.

Quick Defrost provides just enough defrosting that the foods can be used in recipes or for cooking.

There will be some ice crystals remaining.

QUICK DEFROST MENU INSTRUCTIONS

Code	Menu	Weight Limit	Initial Temperature	Instructions	Standing Time (minutes)
1	Minced Meat	0.5 kg	Frozen	Use this function to defrost mince meat. Remove the meat completely from it's wrapping. Place the mince onto a microwave- safe rack over a plate or shallow dish. During the program the oven will beep and display 'turn food over'. At this point remove the mince from the microwave oven, remove any defrosted mince to a plate, cover and set aside. Turn the frozen mince over and return to the microwave oven. Press start to continue. At the end of the program remove the mince from the microwave oven, cover with foil and allow to stand 5- 20 minutes or until completely thawed.	5 - 20

OPERATING INSTRUCTIONS (CONT'D)

KEEP MOISTURE

To reheat Chilled Pizza



1. Touch **STOP/CLEAR**.



2. Touch **KEEP MOISTURE**.
one time. then 'Sc-1' will
shows in the display.





3. Touch number **[4]**.
("0.4kg".)



4. Touch **START**.



KEEP MOISTURE MENU INSTRUCTIONS

Category	Menu	Weight Limit	Initial Temperature	Instructions	Standing Time (minutes)
Reheat	Chilled pizza	0.3~0.6kg	Refrigerated	1. Pour 30ml water on the keep moist plate 2. Place food on microwave - safe plate and put it on the keep moist plate and cover. 3. After reheating, stand for 1 minute.	1
	Rice /Pasta	0.1-0.3kg	Refrigerated	1. Pour 30ml water on the keep moist plate 2. Place food on microwave - safe plate and put it on the keep moist plate and cover. 3. After reheating, stand for 1 minute.	1
	Cake / Bread	0.1-0.3kg	Refrigerated	1. Pour 30ml water on the keep moist plate 2. Place food on microwave - safe plate and put it on the keep moist plate and cover. 3. After reheating, stand for 1 minute.	1
	Soup / Sauce	0.2-0.6kg	Refrigerated	1. Pour 30ml water on the keep moist plate 2. Place food on microwave - safe bowl and put it on the keep moist plate and cover. 3. After reheating, stand for 3 minute.	3

OPERATING INSTRUCTIONS (CONT'D)

KEEP MOISTURE MENU INSTRUCTIONS

Category	Menu	Weight Limit	Initial Temperature	Instructions	Standing Time (minutes)
Cook	Vegetable (hard)	0.2-0.4kg	Room	<ol style="list-style-type: none"> 1. Pour 30ml water on the keep moist plate. 2. Place food on microwave- safe plate(or bowl) and put it on the keep moist plate and cover. 3. After cooking, stand for 2 minute. 	2
	Vegetable (soft)	0.2-0.4kg	Room	<ol style="list-style-type: none"> 1. Pour 30ml water on the keep moist plate. 2. Place food on microwave- safe plate(or bowl) and put it on the keep moist plate and cover. 3. After cooking, stand for 2 minute. 	2
	Fish fillets	0.2-0.6kg	Refrigerated	<ol style="list-style-type: none"> 1. Pour 30ml water on the keep moist plate 2. Place food on microwave- safe plate and put it on the keep moist plate and cover. 	
	Chicken portion	0.2-0.6kg	Refrigerated	<ol style="list-style-type: none"> 1. Pour 30ml water on the keep moist plate 2. Place food on microwave- safe plate and put it on the keep moist plate and cover. 	

OPERATING INSTRUCTIONS (CONT'D)

AUTO DEFROST

Three defrost sequences are preset in the oven. The defrost feature provides you with the best defrosting method for frozen foods. The cooking guide will show you which defrost sequence is recommended for the food you are defrosting.

With the Auto Defrost feature, the oven automatically sets the defrosting time and power levels for you.

The oven automatically determines required defrosting times for each food item according to the weight you enter.

For added convenience, the Auto Defrost includes a built-in beep mechanism that reminds you to check, turn over, separate, or rearrange.

Three different defrosting levels are provided.

- | | |
|----------------|-------------------|
| 1. Minced Meat | 4. Roast Beef |
| 2. Steak/Chops | 5. Whole Chicken |
| 3. Roast Lamb | 6. Chicken Pieces |
| | 7. Sliced Bread |

Example: To defrost 1.2 kg of Minced Meat, select Meat menu, enter the weight, and press START



1. Touch **STOP/CLEAR**.



2. Touch **AUTO DEFROST** one time. 'dEF1' will show in the display.



3. Enter the weight by touching **[1]** and **[2]**. ("1.2kg")



4. Touch **START**. Defrosting starts.

NOTE:

When you touch the START pad, the display changes to defrost time count down. The oven will beep twice during the DEFROST cycle. At each beep, open the door and turn, separate, or rearrange the food.

Remove any portions that have thawed.

Return frozen portions to the oven and touch START to resume the defrost cycle.

*For best results, remove fish, shellfish, meat, and poultry from its original closed paper or plastic package (wrapper). Otherwise, the wrap will hold steam and juice close to the foods, which can cause the outer surface of the foods to cook.

*For best results, shape your ground meat into the form of a doughnut before freezing. When defrosting, scrape off thawed meat when the beep sounds and continue defrosting.

*Place foods in a shallow container or on a microwave roasting rack to catch drippings.

*Food should still be somewhat icy in the center when removed from the oven.

OPERATING INSTRUCTIONS (CONT'D)

AUTO DEFROST MENU INSTRUCTIONS

Code	Menu	Weight Limit	Initial Temperature	Instructions	Standing Time (minutes)
1	Minced Meat	0.1 - 2.0 kg	Frozen	Remove the meat completely from it's wrapping. Place the mince onto a microwave- safe rack over a plate or shallow dish. During the program the oven will beep and display turn food over. At this point remove the mince from the microwave, remove any defrosted mince to a plate, cover and set aside. Turn the frozen mince over and return to the microwave oven. Press start to continue. At the end of the program remove the mince from the microwave oven, cover with foil and allow to stand 5- 20 minutes or until completely thawed.	5 - 20
2	Steak/ Chops	0.1- 1.5kg	Frozen	Remove the meat completely from it's wrapping. Using thin strips of foil, shield the fatty areas with the foil, making sure the foil is secure. Place the meat onto a microwave- safe rack over a plate or shallow dish. During the program the oven will beep and display 'turn food over'. At this point remove the meat from the microwave, remove any defrosted steak or chops to a plate, cover and set aside. Turn the meat over and return to the microwave oven. Press start to continue. At the end of the program remove the meat from the microwave oven, cover with foil and allow to stand 5- 30 minutes or until completely thawed.	5 - 30
3	Roast Lamb	1.0 - 2.0 kg	Frozen	Remove the lamb completely from it's wrapping. Using a piece of foil wrap the shank to prevent cooking. Place the lamb onto a microwave- safe rack over a plate or shallow dish. During the program the oven will beep and display 'turn food over'. At this point remove the lamb from the microwave oven and turn over. Press start to continue. At the end of the program remove the lamb from the microwave oven, cover with foil and allow to stand 5 - 45 minutes or until completely thawed.	5 - 45
4	Roast Beef	1.0 - 2.0 kg	Frozen	Remove the beef completely from it's wrapping. Using strips of foil, shield fatty areas with foil to prevent cooking. Place the beef onto a microwave- safe rack, fat side down over a plate or shallow dish. During the program the oven will beep and display 'turn food over'. At this point remove the beef from the microwave oven and turn over. Press start to continue. At the end of the program remove the beef from the microwave oven, cover with foil and allow to stand 5- 45 minutes or until completely thawed.	5 - 45

OPERATING INSTRUCTIONS (CONT'D)

AUTO DEFROST MENU INSTRUCTIONS

Code	Menu	Weight Limit	Initial Temperature	Instructions	Standing Time (minutes)
5	Whole Chicken	1.0 - 2.5 kg	Frozen	Remove the chicken completely from it's wrapping. Place a thin strip of foil down the centre of the breast. Place the chicken breast side down onto a microwave- safe rack over a plate or shallow dish. During the program the oven will beep and display 'turn food over'. At this point remove the chicken from the microwave oven and turn over. Press start to continue. At the end of the program remove the chicken from the microwave oven, cover with foil and allow to stand 5- 40 minutes or until completely thawed.	5 - 40
6	Chicken Pieces	0.1 - 2.0 kg	Frozen	Remove the chicken pieces completely from it's wrapping. Place the chicken Pieces onto a microwave- safe rack over a plate or shallow dish. During the program the oven will beep and display 'turn food over'. At this point remove the chicken pieces from the microwave oven and turn over. Press start to continue. At the end of the program remove the chicken pieces from the microwave oven, cover with foil and allow to stand 5- 10 minutes hour or until completely thawed.	5 - 10
7	Sliced Bread 1 piece = 30g	1- 4 pieces	Frozen	Separate the frozen bread into single pieces. Place in a single layer directly on the microwave turntable. At the end of the program remove the bread from the microwave oven, stand 1/2 - 1 minute.	1/2 - 1

OPERATING INSTRUCTIONS (CONT'D)

⚠ WARNING: Do not use aluminum foil during cooking cycle.

COOKING TIPS

Meat

1. No special techniques are required. Meat should be prepared as with conventional cooking. Season if desired. Always thoroughly defrost meat before cooking.
2. Place the meat on a microwave roasting rack or microwave-proof plate and place on the turntable.
3. Cook according to the Meat Cooking Chart (below). Use the longer time for large meats and the shorter time for smaller meats. For thicker chops, use the longer time.
4. Turn the meat once halfway through the cooking time.
5. **Let stand** for 5-10 minutes wrapped in foil after cooking. The standing time is very important as it completes the cooking process.
6. Make sure meat, especially pork, is thoroughly cooked before eating.

Meat Cooking Chart

Meat	Microwave Power	Cooking Time Per 0.5 kg
BEEF		
Standing/Rolled Rib		
– Rare	8	8 to 10 minutes
– Medium	8	9 to 11 minutes
– Well-done	8	10 to 13 minutes
Ground Beef (to brown for casserole)	HIGH(100%)	5½-8½ minutes
Hamburgers, Fresh or defrosted (112 g each)		
– 2 patties	HIGH(100%)	2 to 4 minutes
– 4 patties	HIGH(100%)	3 to 5 minutes
PORK		
Loin, Leg	8	12 to 16 minutes
Bacon		
– 4 slices	HIGH(100%)	2 to 3 minutes
– 6 slices	HIGH(100%)	3 to 4 minutes

NOTE: The times listed above are only a guide. Allow for difference in individual tastes and preferences. The times may also vary due to the shape, cut, and composition of the food.

Poultry

1. No special techniques are required. Poultry should be prepared as with conventional cooking. Season if desired.
2. Poultry should be thoroughly defrosted. Remove giblets and any metal clamps.
3. Prick the skin and brush lightly with vegetable oil unless the poultry is self-basting.
4. All poultry should be placed on a microwave roasting rack or a microwave-proof plate and placed on the turntable.
5. Cook according to the instructions in the Poultry Cooking Chart below. Turn over halfway through the cooking time. Because of its shape, poultry has a tendency to cook unevenly, especially in very bony parts. Turning during roasting helps to cook these areas evenly.
6. **Let stand** for 5-10 minutes wrapped in foil after cooking before carving. The standing time is very important, as it completes the cooking process.
7. Make sure poultry is thoroughly cooked before eating. Whole poultry is completely cooked when the juices run clear from the inside thigh when it is pierced with a sharp knife. Poultry pieces should be pierced with a sharp knife through the thickest part to ensure that the juices are clear and the flesh is firm.

Poultry Cooking Chart

Poultry	Microwave Power	Cooking Time Per 0.5 kg
CHICKEN		
Whole	8	10 to 14 minutes
Breast (boned)	8	9 to 13 minutes
Portions	8	10 to 16 minutes
TURKEY		
Whole	8	10 to 14 minutes

NOTES:

- The times listed above are only a guide. Allow for difference in individual tastes and preferences. The times may also vary due to the shape, cut, and composition of the food.
- If whole poultry is stuffed, the weight of the stuffed bird should be used when calculating the cooking time.

OPERATING INSTRUCTIONS (CONT'D)

COOKING TIPS (continued)

Fish

1. Arrange fish in a large shallow non-metallic dish or casserole.
2. Cover with pierced microwave plastic wrap or casserole lid.
3. Place the dish on the turntable.
4. Cook according to the instructions in the Fresh Fish Cooking Chart below. Flakes of butter can be added to the fish if desired.
5. Let stand as directed in the Cooking Chart before serving.
6. After standing time, check to see that the fish is thoroughly cooked. The fish should be opaque and flake easily.

Fish Cooking Chart

Fish	Microwave Power	Cooking Time Per 0.5 kg	Butter	Standing Time
Fish Fillets	HIGH	4 to 7 minutes	Add 15 to 30 ml (1 to 2 tbsp.) lemon juice	2 to 3 minutes
Whole Mackerel, Cleaned and Prepared	HIGH	4 to 7 minutes	–	3 to 4 minutes
Whole Trout, Cleaned and Prepared	HIGH	5 to 8 minutes	–	3 to 4 minutes
Salmon Steaks	HIGH	5 to 7 minutes	Add 15 to 30 ml (1 to 2 tbsp.) lemon juice	3 to 4 minutes

OPERATING INSTRUCTIONS (CONT'D)

To heat or reheat successfully in the microwave, it is important to follow several guidelines. Measure the amount of food in order to determine the time needed to reheat. Arrange the food in a circular pattern for best results. Room temperature food will heat faster than refrigerated food. Canned foods should be taken out of the can and placed in a microwavable container. The food will be heated more evenly if covered with a microwavable lid or plastic wrap and vented. Remove cover carefully to prevent steam burns. Use the following chart as a guide for reheating cooked food.

Items	Cook time (at HIGH)	Special Instructions
Sliced meat 3 slices (0.5 cm thick)	1-2 minutes	Place sliced meat on microwavable plate. Cover with plastic wrap and vent. *Note: Gravy or sauce helps to keep meat juicy.
Chicken pieces 1 breast 1 leg and thigh	2-3½ minutes 1½-3 minutes	Place chicken pieces on microwavable plate. Cover with plastic wrap and vent.
Fish fillet (230 g)	2-4 minutes	Place fish on microwavable plate. Cover with plastic wrap and vent.
Lasagna 1 serving (300 g)	4-6 minutes	Place lasagna on microwavable plate. Cover with plastic wrap and vent.
Casserole 1 cup 4 cups	1-3½ minutes 5-8 minutes	COOK covered in microwavable casserole. Stir once halfway through cooking.
Casserole – cream or cheese 1 cup 4 cups	1½-3 minutes 3½-5½ minutes	COOK covered in microwavable casserole. Stir once halfway through cooking.
Sloppy Joe or Barbecued beef 1 sandwich (½ cup meat filling) without bun	1-2½ minutes	Reheat filling and bun separately. Cook filling covered in microwavable casserole. Stir once. Heat bun as directed in chart below.
Mashed potatoes 1 cup 4 cups	1-3 minutes 5-8 minutes	COOK covered in microwavable casserole. Stir once halfway through cooking.
Baked beans 1 cup	1½-3 minutes	COOK covered in microwavable casserole. Stir once halfway through cooking.
Ravioli or pasta in sauce 1 cup 4 cups	2½-4 minutes 7½-11 minutes	COOK covered in microwavable casserole. Stir once halfway through cooking.
Rice 1 cup 4 cups	1½-3½ minutes 4-6½ minutes	COOK covered in microwavable casserole. Stir once halfway through cooking.
Sandwich roll or bun 1 roll	15-30 seconds	Wrap in paper towel and place on glass microwavable rack
Vegetables 1 cup 4 cups	1½-2½ minutes 4-6 minutes	COOK covered in microwavable casserole. Stir once halfway through cooking.
Soup 1 serving (230 g)	1½-2½ minutes	COOK covered in microwavable casserole. Stir once halfway through cooking.

OPERATING INSTRUCTIONS (CONT'D)

Vegetable	Amount	Cook time at HIGH	Instructions	Standing Time
Artichokes (230 g each)	2 medium 4 medium	5~8 10~13	Trim. Add 2 tsp water and 2 tsp juice. Cover.	2-3 minutes
Asparagus, Fresh, Spears	450 g	3~6	Add 1/2 cup water. Cover.	2-3 minutes
Beans, Green & Wax	450 g	7~11	Add 1/2 cup water in 1 1/2 qt. casserole. Stir halfway through cooking.	2-3 minutes
Beets, Fresh	450 g	12~16	Add 1/2 cup water in 1 1/2 qt. covered casserole. Rearrange halfway through cooking.	2-3 minutes
Broccoli, Fresh, Spears	450 g	4~8	Place broccoli in baking dish. Add 1/2 cup water.	2-3 minutes
Cabbage, Fresh, Chopped	450 g	4~7	Add 1/2 cup water in 1 1/2 qt. covered casserole. Stir halfway through cooking.	2-3 minutes
Carrots, Fresh, Sliced	2 cups	2~4	Add 1/4 cup water in 1 qt. covered casserole. Stir halfway through cooking.	2-3 minutes
Cauliflower, Fresh, Whole	450 g	7~11	Trim. Add 1/4 cup water in 1 qt. covered casserole. Stir halfway through cooking.	2-3 minutes
Flowerettes, Fresh Celery, Fresh, Sliced	2 cups 4 cups	2 1/2~4 1/2 6~8	Slice. Add 1/2 cup water in 1 1/2 qt. covered casserole. Stir halfway through cooking.	2-3 minutes
Corn, Fresh	2 ears	5~9	Husk. Add 2 tbsp water in 1 1/2 qt. baking dish. Cover.	2-3 minutes
Mushrooms, Fresh, Sliced	230 g	2~3 1/2	Place mushrooms in 1 1/2 qt. covered casserole. Stir halfway through cooking.	2-3 minutes
Parsnips, Fresh, Sliced	450 g	4~8	Add 1/2 cup water in 1 1/2 qt. covered casserole. Stir halfway through cooking.	2-3 minutes
Peas, Green, Fresh	4 cups	7~10	Add 1/2 cup water in 1 1/2 qt. covered casserole. Stir halfway through cooking.	2-3 minutes
Sweet Potatoes Whole Baking (170~230 g each)	2 medium 4 medium	5~10 7~13	Pierce potatoes several times with fork. Place on 2 paper towels. Turn over halfway through cooking.	2-3 minutes 2-3 minutes
White Potatoes, Whole Baking (170~230 g each)	2 potatoes 4 potatoes	5~8 10~14	Pierce potatoes several times with fork. Place on 2 paper towels. Turn over halfway through cooking.	2-3 minutes 2-3 minutes
Spinach, Fresh, Leaf	450 g	4~7	Add 1/2 cup water in 2 qt. covered casserole.	2-3 minutes
Squash, Acorn or Butternut, Fresh	1 medium	6~8	Cut squash in half. Remove seeds. Place in 8 x 8-inch baking dish. Cover.	2-3 minutes
Zucchini, Fresh, Sliced	450 g	4 1/2~7 1/2	Add 1/2 cup water in 1 1/2 qt. covered casserole. Stir halfway through cooking.	2-3 minutes
Zucchini, Fresh, Whole	450 g	6~9	Pierce. Place on 2 paper towels. Turn zucchini over and rearrange halfway through cooking.	2-3 minutes

MICROWAVE-SAFE UTENSILS

Never use metal or metal trimmed utensils in your microwave oven

Microwaves cannot penetrate metal. They will bounce off any metal object in the oven and cause arcing, an alarming phenomenon that resembles lightning.

Most heat resistant non metallic cooking utensils are safe for use in your microwave oven.

However, some may contain materials that render them unsuitable as microwave cookware. If you have any doubts about a particular utensil, there's a simple way to find out if it can be used in your microwave oven.

Place the utensil in question next to a glass bowl filled with water in the microwave oven.

Microwave at power HIGH for 1 minute. If the water heats up but the utensil remains cool to the touch, the utensil is microwave-safe. However, if the water does not change temperature but the utensil becomes warm, microwaves are being absorbed by the utensil and it is not safe for use in the microwave oven. You probably have many items on hand in your kitchen right now that can be used as cooking equipment in your microwave oven. Just read through the following checklist.

Dinner plates

Many kinds of dinner-ware are microwave-safe. If in doubt consult the manufacturer's literature or perform the microwave test.

Glassware

Glassware that is heat-resistant is microwave-safe. This would include all brands of oven tempered glass cookware. However, do not use delicate glassware, such as tumblers or wine glasses, as these might shatter as the food warms.

Plastic storage containers

These can be used to hold foods that are to be quickly reheated. However, they should not be used to hold foods that will need considerable time in the oven as hot foods will eventually warp or melt plastic containers.

Paper

Paper plates and containers are convenient and safe to use in your microwave oven, provided that the cooking time is short and foods to be cooked are low in fat and moisture. Paper towels are also very useful for wrapping foods and for lining baking trays in which greasy foods such as bacon are cooked. In general, avoid colored paper products as the colour may run. Some recycled paper products may contain impurities which could cause arcing or fires when used in the microwave oven.

Plastic cooking bags

Provided they are made specially for cooking, cooking bags are microwave safe. However, be sure to make a slit in the bag so that steam can escape. Never use ordinary plastic bags for cooking in your microwave oven, as they will melt and rupture.

Plastic microwave cookware

A variety of shapes and sizes of microwave cookware are available. For the most part, you can probably use items you already have on hand rather than investing in new kitchen equipment.

Pottery, stoneware and ceramic

Containers made of these materials are usually fine for use in your microwave oven, but they should be tested to be sure.

CAUTION

Some items with high lead or iron content are not suitable for cooking utensils.

FOOD CHARACTERISTICS & MICROWAVE COOKING

Keeping an eye on things

The recipes in this book have been formulated with great care, but your success in preparing them depends on how much attention you pay to the food as it cooks. Always watch your food while it cooks. Your microwave oven is equipped with a light that turns on automatically when the oven is in operation so that you can see inside and check the progress of your food. Directions given in recipes to elevate, stir, and the like should be thought of as the minimum steps recommended. If the food seems to be cooking unevenly, simply make the necessary adjustments you think appropriate to correct the problem.

Factors affecting microwave cooking times

Many factors affect cooking times. The temperature of ingredients used in a recipe makes a big difference in cooking times. For example, a cake made with ice-cold butter, milk, and eggs will take considerably longer to bake than one made with ingredients that are at room temperature. All of the recipes in this book give a range of cooking times. In general, you will find that the food remains under-cooked at the lower end of the time range, and you may sometimes want to cook your food beyond the maximum time given, according to personal preference. The governing philosophy of this book is that it is best for a recipe to be conservative in giving cooking times. While overcooked food is ruined for good. Some of the recipes, particularly those for bread, cake, and custards, recommend that food be removed from the oven when they are slightly undercooked. This is not a mistake. When allowed to stand, usually covered, these foods will continue to cook outside of the oven as the heat trapped within the outer portions of the food gradually travels inward. If the food is left in the oven until it is cooked all the way through, the outer portions will become overcooked or even burnt. You will become increasingly skilful in estimating both cooking and standing times for various foods.

Density of food

Light, porous food such as cakes and bread cook more quickly than heavy, dense foods such as roasts and casseroles. You must take care when microwaving porous food that the outer edges do not become dry and brittle.

Height of food

The upper portion of tall food, particularly roasts, will cook more quickly than the lower portion. Therefore, it is wise to turn tall food during cooking, sometimes several times.

Moisture content of food

Since the heat generated from microwaves tends to evaporate moisture, relatively dry food such as roasts and some vegetables should either be sprinkled with water prior to cooking or covered to retain moisture.

Bone and fat content of food

Bones conduct heat and fat cooks more quickly than meat. Care must be taken when cooking bony or fatty cuts of meat that they do not cook unevenly and do not become overcooked.

Quantity of food

The number of microwaves in your oven remains constant regardless of how much food is being cooked. Therefore, the more food you place in the oven, the longer the cooking time. Remember to decrease cooking times by at least one third when halving a recipe.

Shape of food

Microwaves penetrate only about 2.5 cm into food, the interior portion of thick foods are cooked as the heat generated on the outside travels inward. Only the outer edge of food is cooked by microwave energy; the rest is cooked by conduction. The worst possible shape for a food that is to be microwaved is a thick square. The corners will burn long before the centre is even warm. Round thin foods and ring shaped foods cook successfully in the microwave.

Covering

A cover traps heat and steam which causes food to cook more quickly. Use a lid or microwave cling film with a corner folded back to prevent splitting.

Browning

Meats and poultry that are cooked fifteen minutes or longer will brown lightly in their own fat. Food that is cooked for a shorter period of time may be brushed with a browning sauce such as Worcestershire sauce, soy sauce or barbecue sauce to achieve an appetizing colour. Since relatively small amounts of browning sauce is added to food, the original flavour of the recipe is not altered.

Covering with greaseproof paper

Greaseproofing effectively prevents spattering and helps food retain some heat. But because it makes a looser cover than a lid or clingfilm, it allows the food to dry out slightly.

Arranging and spacing

Individual foods such as baked potatoes, small cakes and hors d'oeuvres will heat more evenly if placed in the oven an equal distance apart, preferably in a circular pattern. Never stack foods on top of one another.

FOOD CHARACTERISTICS & MICROWAVE COOKING

Stirring

Stirring is one of the most important of all microwaving techniques. In conventional cooking, food is stirred for the purpose of blending.

Microwaved food, however, is stirred in order to spread and redistribute heat. Always stir from the outside towards the centre as the outside of the food heats first.

Turning over

Large, tall foods such as roasts and whole chickens should be turned so that the top and bottom will cook evenly. It is also a good idea to turn cut up chicken and chops.

Placing thicker portions facing outwards

Since microwaves are attracted to the outside portion of food, it makes sense to place thicker portions of meat, poultry and fish to the outer edge of the baking dish. This way, thicker portions will receive the most microwave energy and the food will cook evenly.

Shielding

Strips of aluminium foil (which block microwaves) can be placed over the corners or edges of square and rectangular food to prevent those portions from overcooking. Never use too much foil and make sure the foil is secured to the dish or it may cause 'arcing' in the oven.

Elevating

Thick or dense foods can be elevated so that microwaves can be absorbed by the underside and centre of the foods.

Piercing

Foods enclosed in a shell, skin or membrane are likely to burst in the oven unless they are pierced prior to cooking. Such foods include yolks and whites of eggs, clams and oysters and whole vegetables and fruits.

Testing if cooked

Food cooks so quickly in a microwave oven, it is necessary to test it frequently. Some foods are left in the microwave until completely cooked, but most foods, including meats and poultry, are removed from the oven while still slightly undercooked and allowed to finish cooking during standing time. The internal temperature of foods will rise between 3°C and 8°C during standing time.

Standing time

Foods are often allowed to stand for 3 to 10 minutes after being removed from the microwave oven. Usually the foods are covered during standing time to retain heat unless they are supposed to be dry in texture (some cakes and biscuits, for example). Standing allows foods to finish cooking and also helps flavour blend and develop.

To Clean Your Oven

1 Keep the inside of the oven clean

Food spatters or spilled liquids stick to oven walls and between seal and door surface. It is best to wipe up spillovers with a damp cloth right away. Crumbs and spillovers will absorb microwave energy and lengthen cooking times. Use a damp cloth to wipe out crumbs that fall between the door and the frame. It is important to keep this area clean to assure a tight seal. Remove greasy spatters with a soapy cloth then rinse and dry. Do not use harsh detergent or abrasive cleaners. The glass tray can be washed by hand or in the dishwasher.

2 Keep the outside of the oven clean

Clean the outside of your oven with soap and water then with clean water and dry with a soft cloth or paper towel. To prevent damage to the operating parts inside the oven, the water should not be allowed to seep into the ventilation openings. To clean control panel, open the door to prevent oven from accidentally starting, and then wipe the control panel with a damp cloth, followed immediately by a dry cloth. Press STOP after cleaning.

3 If steam accumulates inside or around the outside of the oven door, wipe the panels with a soft cloth. This may occur when the microwave oven is operated under high humidity conditions and in no way indicates a malfunction of the unit.

4 The door and door seals should be kept clean. Use only warm, soapy water, rinse then dry thoroughly.

DO NOT USE ABRASIVE MATERIALS, SUCH AS CLEANING POWDERS OR STEEL AND PLASTIC PADS.

Metal parts will be easier to maintain if wiped frequently with a damp cloth.

SAFETY PRECAUTIONS

WARNING

Please ensure cooking times are correctly set as over cooking may result in FIRE and subsequent DAMAGE to the OVEN.

- 1 Do not attempt to tamper with, or make any adjustments or repairs to the door, control panel, safety interlock switches or any other part of the oven. Repairs should only be undertaken by a qualified service technician.
- 2 Do not operate the oven when empty. It is best to leave a glass of water in the oven when not in use. The water will safely absorb all microwave energy, if the oven is accidentally started.
- 3 Do not use the oven for the purpose of dehumidification. It can be the cause of serious damage of safety. (ex. Operating the microwave oven with the wet newspapers, clothes, toys, pet or portable electric devices, etc.)
- 4 Do not cook food wrapped in paper towels, unless your cook book contains instructions, for the food you are cooking.
- 5 Do not use newspaper in place of paper towels for cooking.
- 6 Do not use wooden containers. They may heat-up and char. Do not use ceramic containers which have metallic (e.g. gold or silver) inlays. Always remove metal twist ties. Metal objects in the oven may arc, which can cause serious damage.
- 7 Do not operate the oven with a kitchen towel, a napkin or any other obstruction between the door and the front edges of the oven, which may cause microwave energy leakage.
- 8 Do not use recycled paper products since they may contain impurities which may cause sparks and/or fires when used in cooking.
- 9 Do not rinse the turntable by placing it in water just after cooking. This may cause breakage or damage.
- 10 Small amounts of food require shorter cooking or heating time. If normal times are allowed they may overheat and burn.
- 11 Be certain to place the oven so the front of the door is 8 cm or more behind the edge of the surface on which it is placed, to avoid accidental tipping of the appliance.
- 12 Before cooking, pierce the skin of potatoes, apples or any such fruit or vegetable.
- 13 Do not cook eggs in their shell. Pressure will build up inside the egg which will burst.
- 14 Do not attempt deep fat frying in your oven.
- 15 Remove the plastic wrapping from food before cooking or defrosting. Note though that in some cases food should be covered with plastic film, for heating or cooking.
- 16 If the oven door is damaged, the oven must not be operated until it has been repaired by a qualified service technician.
- 17 If smoke is observed, keep the oven door closed and switch off or disconnect the oven from the power supply.
- 18 When food is heated or cooked in disposable containers of plastic, paper or other combustible materials look at the oven frequently to check if the food container is deteriorating.
- 19 The appliance is not intended for use by young children or infirm persons without supervision; Young Children should be supervised to ensure that they do not play with appliance.
- 20 Liquids or other foods must not be heated in sealed containers since they are liable to explode.
- 21 If the appliance is supplied from a cord extension set or an electrical portable outlet device, the cord extension set on electrical portable outlet device must be positioned so that it is not subject to splashing or ingress of moisture.
- 22 It is hazardous for anyone other than a competent person to carry out any service or repair operation that involves the removal of a cover which gives protection against exposure to microwave energy.
- 23 Only allow children to use the oven without supervision when adequate instructions have been given so that the child is able to use the oven in a safe way and understands the hazards of improper use.
- 24 The oven should be cleaned regularly and any food deposits removed.

SAFETY PRECAUTIONS

WARNING

Please ensure cooking times are correctly set as over cooking may result in FIRE and subsequent DAMAGE to the OVEN.

- 25 Failure to maintain the oven in a clean condition could lead to deterioration of the surface that could adversely affect the life of the appliance and possibly result in a hazardous situation.
- 26 If the supply cord is damaged, it must be replaced by the manufacturer, its service agent or similarly qualified persons in order to avoid a hazard.
- 27 This appliance is not intended for use by persons (including children) with reduced physical, sensory or mental capabilities, or lack of experience and knowledge, unless they have been given supervision or instruction concerning use of the appliance by a person responsible for their safety.
- 28 only use utensils that are suitable for use in microwave ovens

QUESTION & ANSWERS

Q What's wrong when the oven light will not glow?

- A There may be several reasons why the oven light will not glow.
Light bulb has blown.
Door is not closed.

Q Does microwave energy pass through the viewing screen in the door?

- A No. The holes, or ports, are made to allow light to pass; they do not let microwave energy through.

Q Why does the beep tone sound when a pad on the Control Panel is touched?

- A The beep tone sounds to assure that the setting is being properly entered.

Q Will the microwave oven be damaged if it operates empty?

- A Yes. Never run it empty or without the glass tray.

Q Why do eggs sometimes pop?

- A When baking, frying, or poaching eggs, the yolk may pop due to steam build up inside the yolk membrane. To prevent this, simply pierce the yolk before cooking. Never microwave eggs in the shell.

Q Why is standing time recommended after microwave cooking is over?

- A After microwave cooking is finished, food keeps on cooking during standing time. This standing time finishes cooking evenly throughout the food. The amount of standing time depends on the density of the food.

Q Is it possible to pop corn in a microwave oven?

- A Yes, if using one of the two methods described below:

- 1 Popcorn-popping utensils designed specifically for microwave cooking.
- 2 Prepackaged commercial microwave popcorn that contains specific times and power outputs needed for an acceptable final product.

FOLLOW EXACT DIRECTIONS GIVEN BY EACH MANUFACTURER FOR THEIR POPCORN PRODUCT. DO NOT LEAVE THE OVEN UNATTENDED WHILE THE CORN IS BEING POPPED. IF CORN FAILS TO POP AFTER THE SUGGESTED TIMES, DISCONTINUE COOKING. OVERCOOKING COULD RESULT IN THE CORN CATCHING FIRE.

CAUTION

NEVER USE A BROWN PAPER BAG FOR POPPING CORN. NEVER ATTEMPT TO POP LEFTOVER KERNELS.

Q Why doesn't my oven always cook as fast as the cooking guide says?

- A Check your cooking guide again to make sure you've followed directions correctly, and to see what might cause variations in cooking time. Cooking guide times and heat settings are suggestions, chosen to help prevent overcooking, the most common problem in getting used to a microwave oven. Variations in the size, shape, weight and dimensions of the food require longer cooking time. Use your own judgement along with the cooking guide suggestions to test food condition, just as you would do with a conventional cooker.

PLUG WIRING INFORMATION

Warning

This appliance must be earthed

The wires in this mains lead are colored in accordance with the following codes
BLUE ~ Neutral
BROWN ~ Live
GREEN & YELLOW ~ Earth

TECHNICAL SPECIFICATIONS

MODEL	MS3840SRSK
Power Supply	230 / 240 V~ 50 Hz
Rated Power Consumption	1600 W
Microwave Output	*1100 W
Frequency	2450 MHz
Overall Dimensions(WXHXD)	556 X 320 X 443 (mm)
Oven Cavity Dimensions(WXHXD)	398 X 265 X 402 (mm)
NET WEIGHT	18.0Kg
SHIPPING WEIGHT	20.0Kg

*IEC 60705 RATING STANDARD

Specifications subject to change without prior notice.

LG MICROWAVE OVEN

MANUFACTURER'S WARRANTY

Complete the details on this form and retain in the event of warranty service being required (purchase receipt attached).

PURCHASER'S NAME _____

ADDRESS _____

CITY _____

STATE _____

POST CODE _____

MODEL NO	SERIAL NO
DATE OF PURCHASE	INVOICE/SALES DOCKET NO

RETAILER'S NAME _____

ADDRESS _____

CITY _____

STATE _____

POST CODE _____

TERMS OF WARRANTY

MANUFACTURER'S WARRANTY

Should a defect become apparent, due to either FAULTY MATERIAL or WORKMANSHIP, within the period of 2 years from the date of original purchase of the product, LG will then rectify the manufacturing defect without cost to you for either labour or material, at the premises of LG or their Authorised Service Center

Subject to:

1. Particulars of the model and serial number, the date of original purchase and invoice/sales docket number being given to the authorised service centre when a claim under warranty is made. Purchase receipt must be produced.
2. All (a) damage resulted from incorrect installation or misuse other than in accordance with the operating instructions issued by the Company (b) consequential damage being excluded from this Warranty.
3. The Warranty being rendered invalid if the product is misused or if any unauthorized alteration, modification, or substitution of the product is defaced or altered.
4. Costs of transportation both ways to and from the authorized service centre being are paid by the owner if it is necessary to return the product or any part to an authorized service centre.
5. A charge being accepted by the owner for travelling expenses incurred in connection with warranty service at the user's home.
6. The warranty not applying except to the serving within Australia or New Zealand of products purchased in Australia or New Zealand.

7. The authorised serviced agent will provide service during normal business hours, Monday to Friday. If any legislation whether Federal or State to applies to this transaction, certain non-excludable conditions may be implied and certain non-excludable rights may arise but except for such conditions, warranties and rights, all conditions and warranties which might otherwise be implied in this transaction are hereby excluded and negated.
8. This warranty is not transferable and applies to the original purchaser only.

IMPORTANT NOTICE

1. LG ELECTRONICS AUSTRALIA PTY. LTD has arranged for authorised service centres to perform all after sales and warranty service on its behalf.
2. The authorised service centre can accept no responsibility for damage in transit to and from his premises.
3. If the product or any parts returned to an authorised service centre for any cause not covered by this warranty, all costs involved, including a charge for inspection and handing must be paid to the authorised service centre.
4. Changes not covered by the terms of this Warranty must be borne by the owner. Such charges may arise through the cost of any service all where (a) the product is found to be in good installation, or (b) maladjustment of user controls, or failure to follow operating instructions, mains supply defects or external interference has occurred.
5. No retailer has authority to vary the terms of the above warranty.
6. For warranty service please contact LG service on 1300 54 2273(AUSTRALIA), or 0800 54 2273(NEW ZEALAND).



LGEAP

**FOR WARRANTY SERVICE PLEASE CONTACT
LG SERVICE ON 1300 LG CARE (1300 54 2273) AUSTRALIA,
OR 0800 LG CARE (0800 54 2273) NEW ZEALAND.**

LG Electronics Australia
2 Wonderland Drive
Eastern Creek NSW 2766
(ABN: 98 064 531 264)

LG Customer Information Centre

All Product related queries or questions
Please contact

Toll free number
AUSTRALIA **1300 54 2273**
NEW ZEALAND **0800 54 2273**

Customer Service Website:
<http://au.lgservice.com>

Please refer to the owner's manual for
connection and operation related issues,
prior to contacting customer
information centre.