

dyson

Range brochure

No loss of suction.
No awkward moves.



Dyson supporting

**ASTHMA
FOUNDATIONS**
AUSTRALIA









“We look at every detail: how machines move, how people use them, how to reduce raw materials while staying strong. The priority is always the same – improvement.”





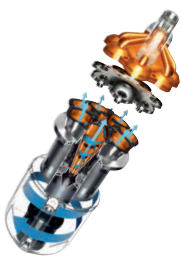



James Dyson

JAMES DYSON
Inventor of cyclone vacuum technology



Over 35 years of invention

<p>Ballbarrow</p> 	<p>Dual Cyclone™ technology</p> 	<p>DC02</p> 	<p>Radix Cyclone™ technology</p> 	<p>Ball™ technology</p> 	<p>Dyson Airblade™ hand dryer</p>  
<p>1974</p> <p>While renovating, James designs the Ballbarrow. A wheelbarrow with a load-spreading ball that stops it sinking into the mud.</p>	<p>1993</p> <p>Dual Cyclone™ technology and DC01, the first vacuum with no loss of suction.</p>	<p>1995</p> <p>Dyson cyclone technology is developed to fit the shape of a barrel vacuum. Within 14 months, it's the UK's best-selling barrel.</p>	<p>2001</p> <p>Dyson develops Radix Cyclone™ technology. Dust and dirt is now captured from the airflow using eight cyclones.</p>	<p>2005</p> <p>No more wheels. DC15 rides on a ball to steer without the awkward moves of conventional vacuums.</p>	<p>2006</p> <p>The Dyson Airblade™ hand dryer uses 640km/h sheets of air, scraping water from hands in just 10 seconds.</p>

<p>Radix Cyclone™ technology + intermediary cyclone</p> 	<p>Dyson digital motor</p> 	<p>DC31 Handheld</p>  	<p>Air Multiplier™ technology</p>  	<p>Dyson Digital Slim™</p> 	<p>Dyson Ball™ barrel vacuum</p> 
<p>2008</p> <p>Improved cyclone technology includes an intermediary cyclone, to capture even more microscopic dust than any other cyclone.</p>	<p>2009</p> <p>The Dyson digital motor is smaller than conventional motors, yet it spins up to 104,000rpm – five times faster than a racing car engine.</p>	<p>2009</p> <p>The next generation of Dyson handhelds, powered by the Dyson digital motor. It's the most powerful handheld.</p>	<p>2009</p> <p>The Dyson Air Multiplier™ fan with no blades. Air is amplified 15 times, giving an uninterrupted stream of smooth air.</p>	<p>2010</p> <p>The Dyson Digital Slim™ vacuum cleaner has twice the suction of any other lightweight cordless vacuum cleaner - and it doesn't lose suction.</p>	<p>2011</p> <p>Turns on the spot. The only barrel vacuum cleaner with a central steering mechanism - for greater control.</p>

The Dyson Airblade™ hand dryer was awarded the Carbon Reduction Label from the Carbon Trust and Planet Ark for the product's life cycle measurement and communication of total greenhouse gas emissions released, along with a commitment to further reduce these emissions in the next two years. The Australian International Design Award™ is the independent symbol of product design excellence. It represents that this product has been assessed by an independent panel of Australian and international design experts who recommend that Standards Australia endorse it as an example of design excellence. Australian International Design Awards. A division of Standards Australia.

Other vacuum cleaners lose suction



Bagless vacuum cleaners lose suction.

Although they might look similar to one another, many other bagless vacuum cleaners have inefficient cyclones. They capture less dirt than others so rely on filters to trap it instead. Just like bags, these disposable filters clog during use causing suction to drop.



Bagged vacuum cleaners can lose suction too.

James Dyson developed vacuum cyclone technology because bagged vacuum cleaners lose suction. When you use them, pores in the bag clog with dust causing suction to drop.

Dyson cyclone technology doesn't lose suction



**With a Dyson vacuum cleaner there's
no loss of suction.**

Dyson vacuum cleaners don't have bags and don't rely on filters.
Dyson cyclone technology generates forces up to 100,000G
to separate even microscopic particles from the airflow.
So there's no loss of suction.

Captures more dirt than any other cyclone

Dyson has been continually refining cyclone technology since inventing it more than 20 years ago.

Radial Cyclone™ technology has been developed with remodelled airflows to maximise suction. Improved flow efficiency reduces turbulence and preserves air pressure, so more microscopic particles are extracted by the inner cyclones. These refinements help remove more dirt, dust, allergens and pet hair from the home.

Cyclone gaskets

The airtight seals within the cyclone assembly are made from materials designed to maintain high pressure differentials.

Self-inflating seal

Maintains pressure difference in cyclone chambers.





Vortex fingers

Guide air from inner cyclones, reducing turbulence and noise.

Inner cyclones

A symmetrical array of smaller cyclones generate centrifugal forces, extracting microscopic particles down to 0.5 microns in size, including mould spores and bacteria.



Sand



Pollen



Allergens



Bacteria

Shroud

The design means the outer cyclone captures debris allowing refinement of the inner cyclone to remove fine dust.



Dust and fluff

Outer cyclone

Dirty air is spun around a vertical axis, generating centrifugal forces that fling larger debris and hair from the airflow into the bin.



Hair and dirt

Choosing the right Dyson vacuum cleaner

Here's a few things to consider when choosing a new Dyson vacuum cleaner:

Type of clean

- For the main clean, choose a barrel or upright vacuum that best suits your house size
- For quick, in-between cleans, a handstick is ideal
- For spot cleans, choose a handheld



Size of house

- A full size vacuum cleaner is best suited to family homes
- For villas or apartments, a medium size vacuum cleaner is ideal
- In small studios or one bedroom flats, choose a compact vacuum cleaner



Type of floor

- Different heads are designed for improved pick-up on different surfaces
- A turbine or motorised head provides high pick-up on carpets
- A hard floor tool improves pick-up on hard floors and tiles



Pet hair removal

- Dyson turbine or motorhead models are best for homes with pets
- Dyson Animal models have an extra tool to remove pet hair from upholstery
- Consider the Groom tool accessory for mess-free grooming of your dog



Allergy sufferers

- All Dyson Uprights and Barrels are accepted by the National Asthma Council Australia
- Dyson HEPA machines capture more microscopic particles
- Dyson Allergy models have a mattress tool to remove dust mite faeces



Manoeuvrability

- Dyson Ball™ Barrels pivot on the spot and follow without the awkward moves
- Dyson Ball™ Uprights steer smoothly with the turn of the wrist, manoeuvring easily around furniture, obstacles and into difficult places

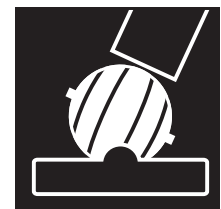

BARRELS

Large - for family homes

Medium - for villas and apartments

Small - for studios and one bedroom flats

NEW



DC
39



DC
23



DC
29



DC
22



DC
26

UPRIGHTS

Large - for family homes

Medium - for villas and apartments

Small - for studios and one bedroom flats

NEW



DC
41



DC
33



DC
25



DC
24

HANDHELDS

For spot cleans

DC
34



DC
30



HANDSTICKS

For in-between cleans

DC
35



dyson ball

No loss of suction.
No awkward moves.

Radial Cyclone™ technology
Remodelled airflows maximise suction.



Ball™ technology
Turns on the spot. The only barrel vacuum cleaner with a central steering mechanism – for greater control.

Ball engineering

The ball houses many of the major vacuum cleaner components: motor, polycarbonate air ducts and cable. This lowers the centre of gravity, making the machine easy to control.

Cable rewind system

Positioned for balanced weight distribution.

Integrated air duct

Airflow reaches the motor efficiently, with minimal loss of airspeed and energy.

Centralised motor

Located at the bottom of the ball to lower the centre of gravity.

Axle bearings

Bearings in the axle reduce friction, enabling the ball to rotate smoothly.

Vibration isolation mounts

Suspending the motor and motor housing transmits less motor noise and vibration.

Ball underside

The ball's smooth surface means it doesn't dig into carpet pile.



**DC
39**

Engineered to remove more dust.
Follows without the awkward moves.



Captures more dirt than any other cyclone

Radial Cyclone™ technology has remodelled airflows to maximise suction.

Combination accessory tool

Nozzle converts to a brush tool for dusting.



Stair tool

For improved stair cleaning.



Suction release trigger

Reduces suction so you can clean curtains, upholstery or rugs without them sticking to the cleaner.

Swivel cuff

Prevents hose from twisting during use.

Captures allergens, expels cleaner air

Dyson cyclones can capture particles down to 0.5 microns – including pollen, mould and bacteria.

Lifetime HEPA filter

For allergy sufferers. Captures pollen, bacteria and mould spores.

Tough, durable construction

Made from the strongest materials available to withstand bumps.

Lightweight adjustable wand

Adjust to length you need.

No extra costs

Other machines are still designed to need replacement bags or filters.

Air Switch

Activated by a change in air pressure, this switches the brush bar on and off.

Low hose connection point

Keeping the applied force closer to the ground increases stability when pulled.



Approved by the National Asthma Council Australia.



Detachable handle

Attach tools directly, to clean awkward places.

Clear bin

Made from tough polycarbonate. Lets you see when it needs emptying.

Hygienic bin emptying

Just push the button, no need to touch the dirt.

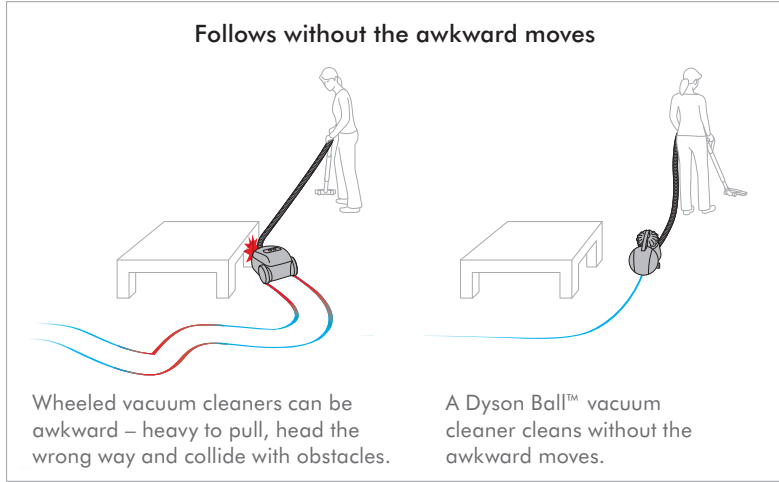

Ball™ technology

Turns on the spot. The only barrel vacuum cleaner with a central steering mechanism – for greater control.



Articulating cyclone pack

The cyclone pack articulates with the chassis, so it's easy to control when moving around obstacles.

Smooth cable rewind

Cable rewind system has increased torque, so it's faster and less likely to catch on obstacles.

Axle bearings

Bearings in the axle reduce friction, enabling the ball to rotate smoothly.

Flexible cuff

Acts as a shock-absorber – re-aligning the machine to keep it on course when pulled.

Low centre of gravity

The balanced arrangement and low motor position provide a low centre of gravity - maximising stability.

Ball underside

The ball's smooth surface means it doesn't dig into carpet pile.

New cleaner head technology

Musclehead™ tool

Self-adjusts across all floor types.
Low profile for cleaning under furniture.



Self-adjusts for hard floors

On hard floors, the Musclehead™ tool brushes stay in contact with the floor removing debris from the surface.



Self-adjusts for carpets

When the head moves across a carpet, the pile agitates the surface recognition switch. This lifts the brushes, exposing the carpet to the dual channel edges that remove dirt trapped within the weave.



Triggerhead tool

The only turbine head activated at the handle. No more bending down.



Pressure Trigger

Creates a drop in pressure which switches the turbine head on and off. No wires, no electronics.



Air switch

Activated by a change in air pressure, this switches the brush bar on and off.

**DC
39** multi floor



Cleans every floor type.



Musclehead™ tool

Self-adjusts to maintain contact with the floor for a quicker clean. Switches easily between carpet and hard floors.

**DC
39** allergy



For high performance on carpets and mattresses. Ideal for people with asthma and allergies.



Triggerhead tool

For high dirt and pet hair pick-up from carpets. Brush bar can be turned off at the handle for delicate rugs and hard floors.

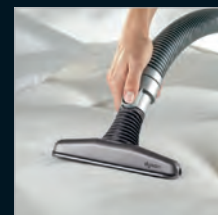

Mattress tool

Removes dirt and dust mite faeces from mattresses and upholstery.

**DC
39** animal



Powerful all-round pet hair removal. High performance on carpets, hard floors and upholstery.



Triggerhead tool

For high dirt and pet hair pick-up from carpets. Brush bar can be turned off at the handle for delicate rugs and hard floors.



Swivel hard floor tool

For high pick-up on hard floors.



Mini turbine head

For pet hair pick-up.

DC 23 motorhead

Ideal for deep cleaning of carpets.



Easy steer motorised head

Motorised brush bar for best pet hair and dirt pick-up from carpets. Foot operated brush control turns the brush bar off to protect delicate rugs and hard floors.



Hard floor tool

With debris channel for high pick-up on hard floors.



Telescope Wrap™ system

Hose and wand compress and wrap for easier storage.

Radix Cyclone™ technology + intermediary cyclone

Doesn't lose suction. With an extra stage of separation to boost efficiency.



Captures allergens, expels cleaner air

Dyson cyclones can capture particles down to 0.5 microns – including pollen, mould and bacteria.

Hygienic one-touch bin emptying

Just push the button, no need to touch the dirt.

On-board tool storage

Brush, crevice and stair tools store on the machine so they're always on hand.

Sits on stairs

Designed to sit on stairs while you clean them.

Lifetime HEPA filter and Bactisafe™ screen

HEPA filter with Bactisafe™ screen traps and kills bacteria and mould on contact. Ideal for people with asthma and allergies.



Approved by the National Asthma Council Australia.

DC 29 multi floor

Cleans every floor type.



Dual mode floor tool

For dirt pick-up on all floor types. Switches easily between carpets and hard floors.

Swivel cuff

Prevents hose from twisting during use.

Detachable handle

Click-fit tools directly to the end of the hose for cleaning confined spaces.

Suction release trigger

Clean curtains, upholstery or rugs without them sticking to the cleaner.

Convenient tool storage

Combination accessory tool and stair tool store on the wand so they're always on hand.

Lightweight adjustable wand

Adjusts to the length you need.

Radix Cyclone™ technology

Patented Dyson technology that doesn't lose suction as you vacuum.

Captures allergens, expels cleaner air

Dyson cyclones can capture particles down to 0.5 microns – including pollen, mould and bacteria.

Lifetime HEPA filter

Ideal for people with asthma and allergies.



Approved by the National Asthma Council Australia.

DC 22 turbine

Compact. For high performance on carpets and hard floors.



Turbine head

For high dirt and pet hair pick-up from carpets. Brush bar can be turned off for delicate rugs and hard floors.



Swivel hard floor tool

180° pivot and debris channel for high pick-up on hard floors.



Telescope Wrap™ system with lightweight wand

Hose and lightweight wand compress and wrap for easier storage.

Radix Cyclone™ technology + intermediary cyclone

Doesn't lose suction. With an extra stage of separation to boost efficiency.



Variable suction

Clean curtains, upholstery or rugs without them sticking to the cleaner.

Convenient tool storage

Combination accessory tool and stair tool store on the wand so they're always on hand.

Concentrated technology

1/3 smaller and lightweight. Ideal for villas and apartments.

Hygienic one-touch bin emptying

Just push the button, no need to touch the dirt.

Captures allergens, expels cleaner air

Dyson cyclones can capture particles down to 0.5 microns – including pollen, mould and bacteria.

Lifetime HEPA filter

Ideal for people with asthma and allergies.



Approved by the National Asthma Council Australia.

DC 26 hepa

Compact. For all floor types.



Dual channel floor tool

Two separate airflow channels direct suction evenly - for dirt pick-up across all floor types.



Swivel hard floor tool

180° pivot and debris channel for high pick-up on hard floors.



Small in size, big on performance.

Ideal for studios and one bedroom flats.



Women's Weekly
Product of the year 2011



Approved by the National
Asthma Council Australia.

Radix Cyclone™ technology

Patented Dyson technology that doesn't lose suction as you vacuum.

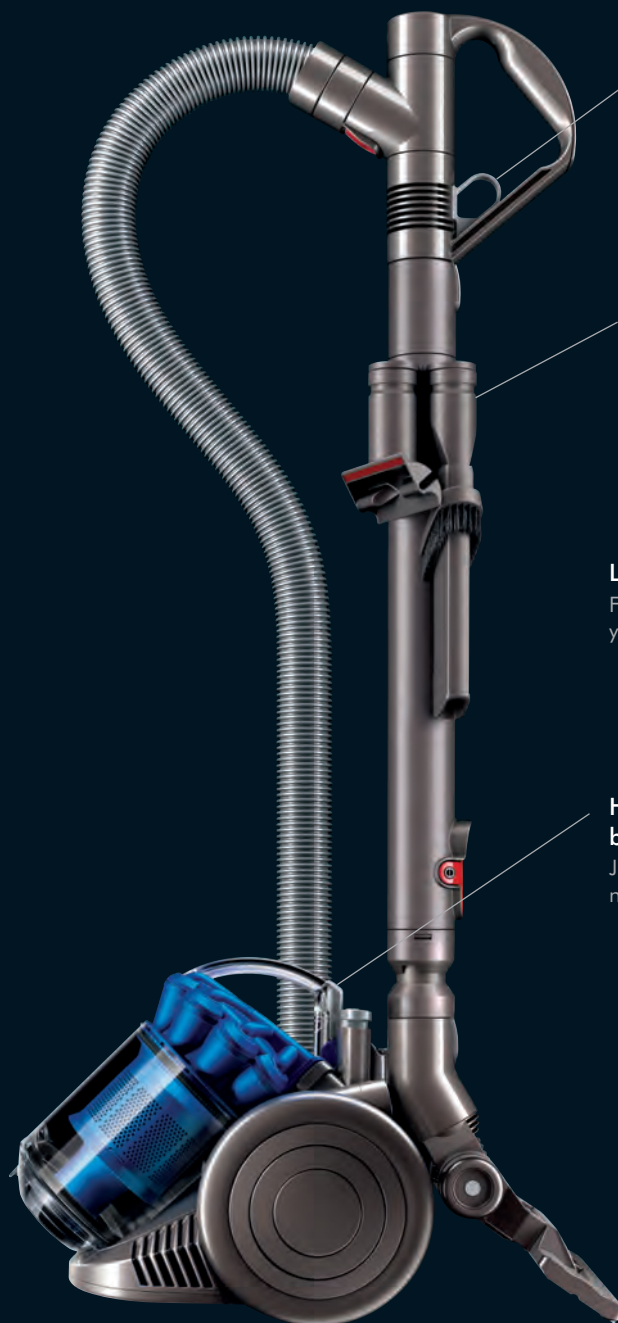

Variable suction

Clean curtains, upholstery or rugs without them sticking to the cleaner.

Convenient tool storage

Combination brush/crevice tool and stair tool store on the wand so they're always on hand.

Lightweight adjustable wand

Full-size wand adjusts to the length you need.

Hygienic one-touch bin emptying

Just push the button, no need to touch the dirt.

Captures allergens, expels cleaner air

Dyson cyclones can capture particles down to 0.5 microns – including pollen, mould and bacteria.

Lifetime HEPA filter

Ideal for people with asthma and allergies.

dyson ball

No loss of suction.
No awkward moves.

Radial Cyclone™ technology
Remodelled airflows to maximise suction.

Ball™ technology
Turns on the spot with no awkward moves. It's easy to steer along edges and into awkward gaps.

Self-adjusting cleaner head
Brush bar height self-adjusts across all floor types. No fiddly dials or bending down to make adjustments.



Self-adjusting cleaner head

Many vacuum cleaners use fixed settings and don't adjust to different floor types – the bigger the gap, the more suction is wasted.

DC41 has an active base plate. It creates the optimal cleaner head contact for every floor type, reducing air leaks and retaining suction.



How it works:

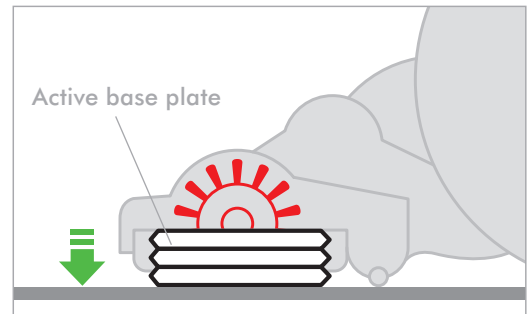

On hard floors

The base plate lowers to create an efficient seal. The brush bar lifts clear of the floor to protect delicate surfaces.

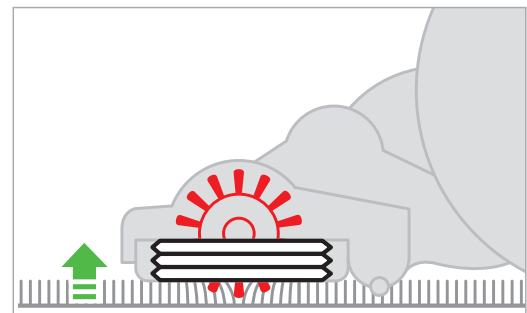

On carpet

The base plate rises and the brush bar lowers for optimum bristle penetration – removing ground-in dirt and pet hair from different depths of carpet pile.

Easy to use

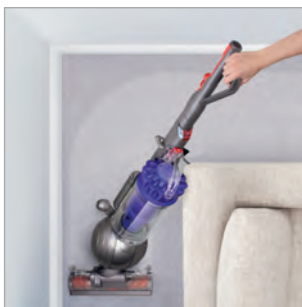

Turns on the spot

Ball™ technology steers smoothly. Allows easy access to awkward spaces.

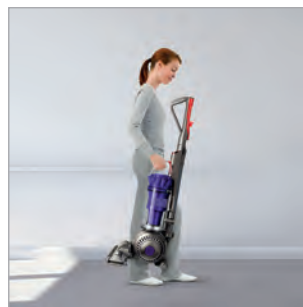

Durable

Engineered materials are selected for their strength and durability.



Instant release wand

Stretches up to 5 times in length for stairs and hard to reach places.



Hygienic one-touch bin emptying

Just push the button, no need to touch the dirt.

DC 41 animal

Powerful all-round pet hair removal. Easy to steer.
High performance on carpets, hard floors and upholstery.



Strongest suction at the cleaner head

Optimal cleaner head contact with every floor type, reducing air leaks for more suction.



Combination floor tool

For all floor types. Low reach to clean under beds and sofas.



Mini turbine head

Ideal for picking up pet hair from stairs and upholstery.

Ball™ technology

Turns on the spot with no awkward moves. It's easy to steer closer to edges and into awkward gaps.

Pedal-free automatic recline mechanism

Simply recline and go.



Approved by the National Asthma Council Australia.

Radial Cyclone™ technology

Remodelled airflows maximise suction.

Instant release wand

Stretches up to 5 times in length for stairs and hard to reach places.

Fingertip control

To instantly turn the motorised brush bar off for delicate rugs and hard floors.

Hygienic one-touch bin emptying

Just push the button, no need to touch the dirt.

Tough, durable construction

Engineered materials are selected for their strength and durability.

On-board tool storage

Combination accessory tool and stair tool are stored on the machine so they're always on hand.

Captures allergens, expels cleaner air

Dyson cyclones can capture particles down to 0.5 microns – including pollen, mould and bacteria.

Self-adjusting cleaner head

Brush bar height self-adjusts across all floor types. No fiddly dials or bending down to make adjustments.



DC 25 allergy

For high performance on carpets and mattresses.
Ideal for people with asthma and allergies.



Motorised brush bar and brush control

Motorised brush bar removes more pet hair and dirt from carpets. Turn the brush bar off at the touch of a button to protect delicate rugs and hard floors.

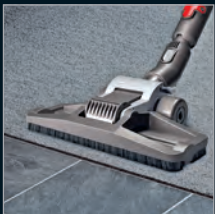

Combination floor tool

For all floor types. Low reach to clean under beds and sofas.



Mattress tool

Removes dirt and dust mite faeces from mattresses and upholstery.

Ball™ technology

Turns on the spot with no awkward moves.

Radix Cyclone™ technology

Patented Dyson technology that doesn't lose suction as you vacuum.

Quick-draw Telescope Reach™ wand

For instant stair and high reach cleaning.

Fingertip control

To instantly turn the motorised brush bar off for delicate rugs and hard floors.

Hygienic one-touch bin emptying

Just push the button, no need to touch the dirt.

Ergonomic carry handle

Designed and positioned for comfortable carrying.

On-board tool storage

Combination accessory tool and stair tool are stored on the machine so they're always on hand.

Captures allergens, expels cleaner air

Dyson cyclones can capture particles down to 0.5 microns – including pollen, mould and bacteria.

Lifetime HEPA filter

Ideal for people with asthma and allergies.

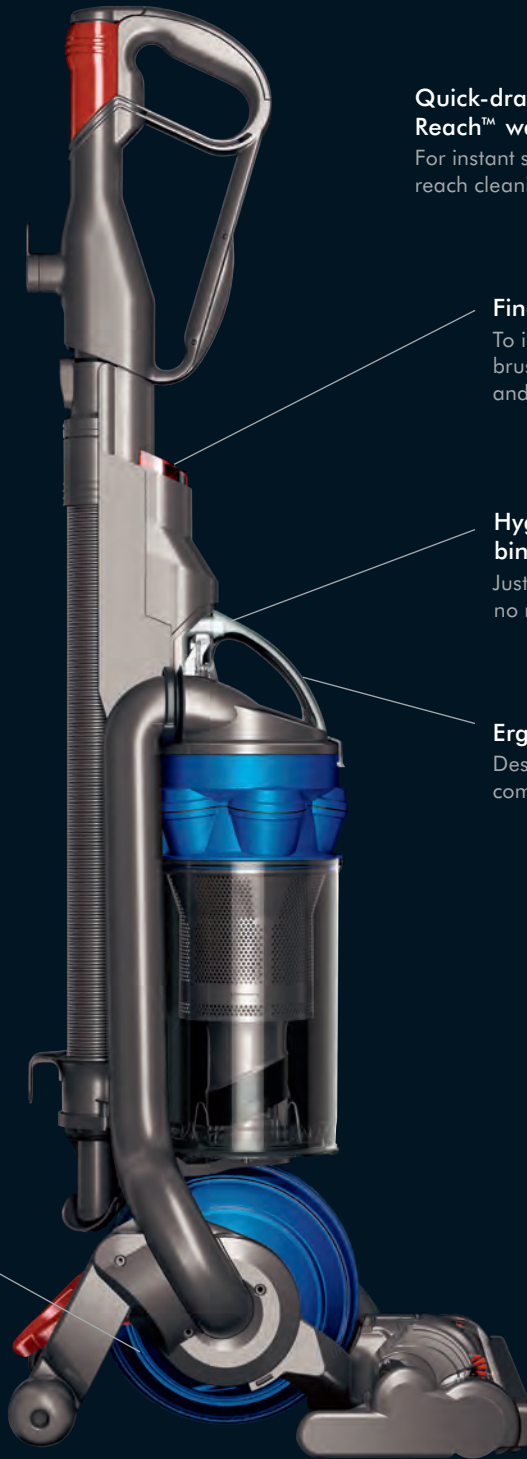

Approved by the National
Asthma Council Australia.

DC 24 hepa

Compact. For high performance on carpets and hard floors.



Motorised brush bar and brush control

Motorised brush bar removes more pet hair and dirt from carpets. Turn the brush bar off at the touch of a button to protect delicate rugs and hard floors.



Mini Flat Out™ head

Compact and low profile for easy cleaning under very low furniture.



Reversible wand

Reversible wand for stairs and high-reach cleaning.

Radix Cyclone™ technology

Patented Dyson technology that doesn't lose suction as you vacuum.

Concentrated technology

Picks up as much as a full-size Dyson upright. Ideal for smaller homes.

Shrinks to store away

The handle compresses to 1/3 of its height, so you can store it in small spaces.

Fingertip brush control

Turn the brush bar on and off at the touch of a button.

Hygienic one-touch bin emptying

Just push the button, no need to touch the dirt.

Combination accessory tool

Nozzle converts to a brush tool for dusting.

Captures allergens, expels cleaner air

Dyson cyclones can capture particles down to 0.5 microns – including pollen, mould and bacteria.

Ball™ technology

Steers smoothly with a turn of the wrist.



Lifetime HEPA filter

Ideal for people with asthma and allergies.



Approved by the National Asthma Council Australia.

DC 33 multi floor

Cleans every floor types.



Brush control

Lets you switch the brush bar off to protect delicate rugs and hard floors.



Combination floor tool

Switches easily between carpets and hard floors. Low reach to clean under beds and sofas.

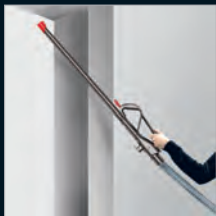

Telescope Reach™ wand

Telescope wand for stairs and high reach cleaning.



Radix Cyclone™ technology

Patented Dyson technology that doesn't lose suction as you vacuum.

Hygienic one-touch bin emptying

Just push the button, no need to touch the dirt.

On-board tool storage

Combination accessory tool and stair tool are stored on the machine so they're always on hand.

Captures allergens, expels cleaner air

Dyson cyclones can capture particles down to 0.5 microns – including pollen, mould and bacteria.

Lifetime HEPA filter

Ideal for people with asthma and allergies.

Auto carpet height adjustment

No awkward dials to adjust.



Approved by the National Asthma Council Australia.

Dyson cordless vacuum cleaners

Radix Cyclone™ technology
Patented technology that doesn't lose suction as you vacuum.

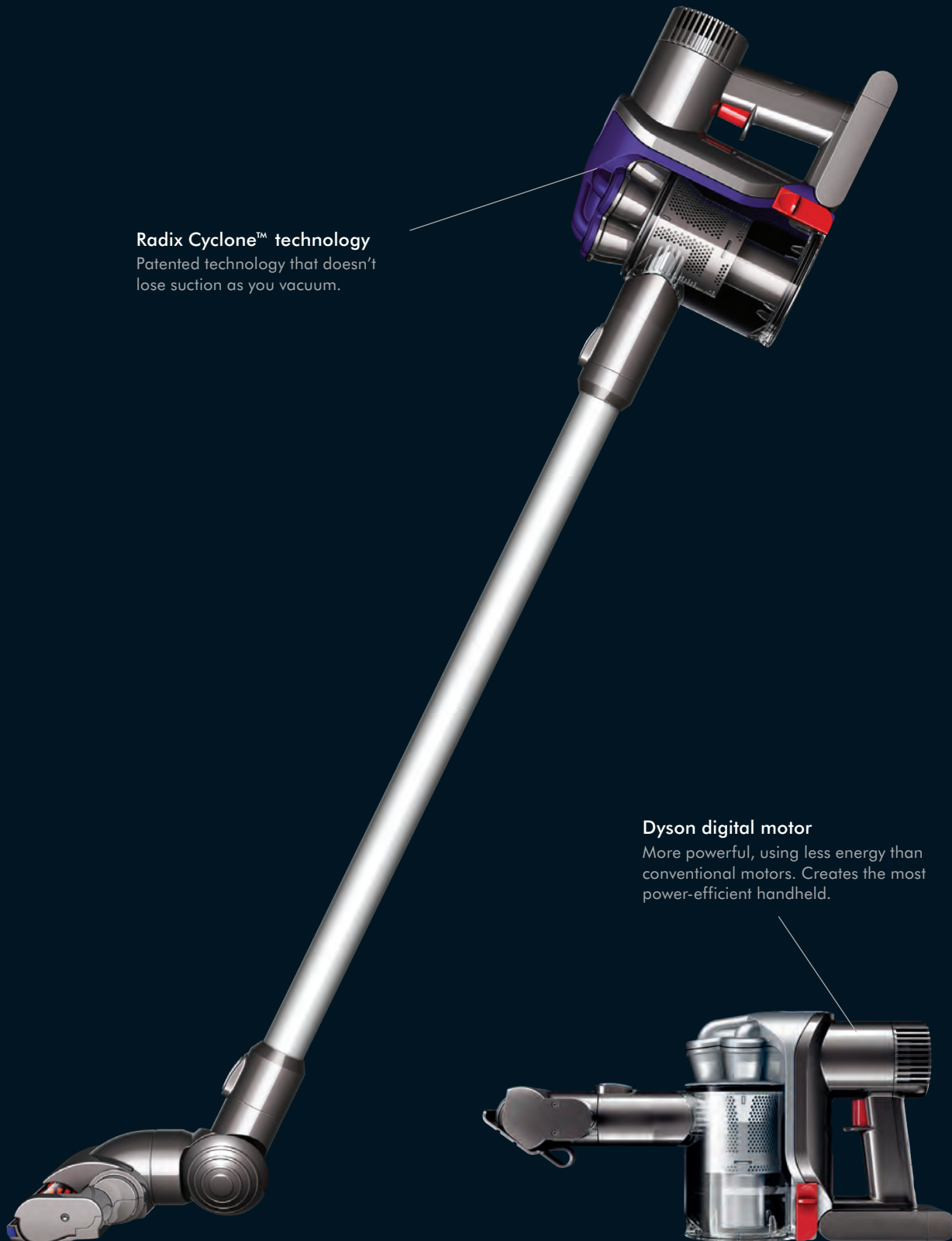

Dyson digital motor
More powerful, using less energy than conventional motors. Creates the most power-efficient handheld.

Concentrated technology

Concentration is about making something smaller without compromising performance or durability. For Dyson engineers, it's a systematic process where every component is interrogated and painstakingly developed and tested. Smaller and lighter without compromising performance.

Dyson digital motor

Conventional motors work by passing current through their carbon brushes, making them spin. Lots of sparks, heat and wasted energy. In the Dyson digital motor, intelligent electronics constantly adjust to create a powerful magnetic field – spinning a neodymium magnet up to 104,000 times a minute.

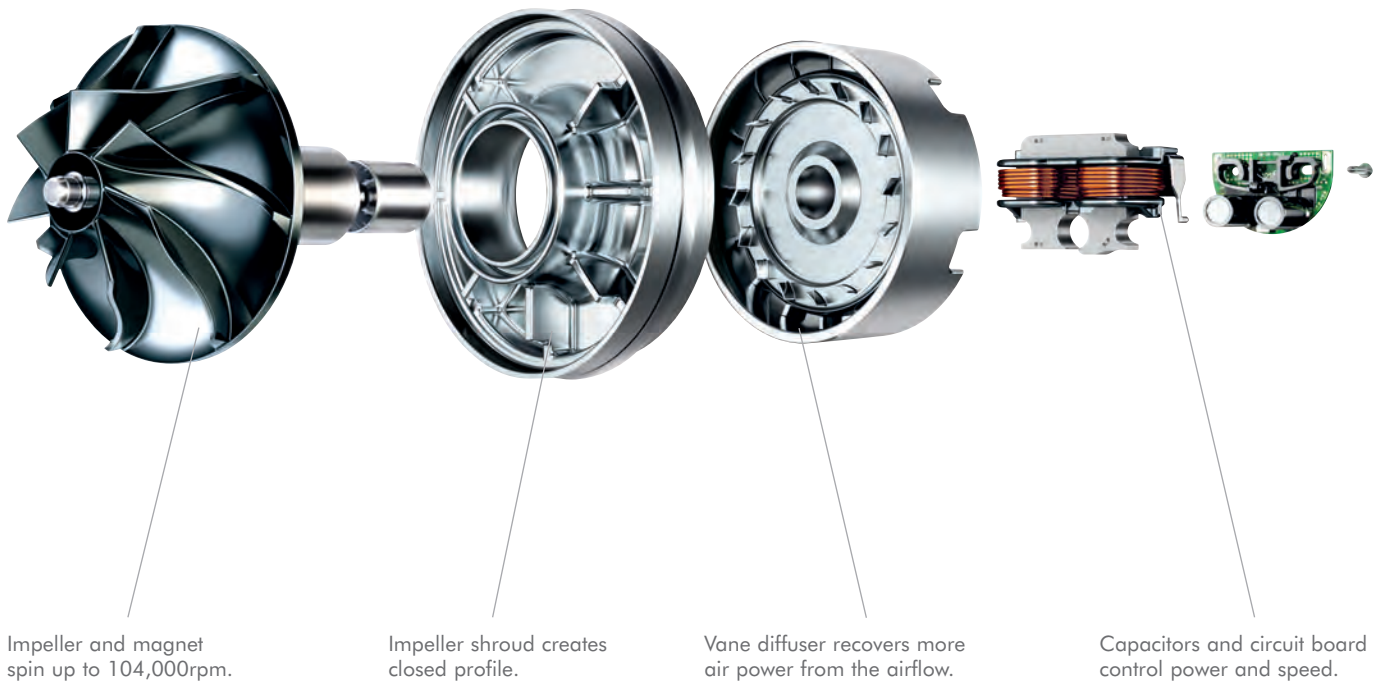

dyson digital slim

Twice the suction of any other lightweight cordless vacuum cleaner in use.



Powered by Dyson digital motor

Up to 3 times faster than conventional motors. Creates the most power-efficient cordless vacuum cleaner.



Lithium-ion battery

Recharges up to 3 times faster than others.

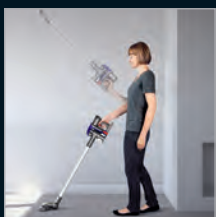

Up top, down below and in-between

Includes tools and wand for cleaning every floor type and awkward spaces.

Dual power mode

15 minutes

High constant suction. (13 mins with motorised tools attached).

6 minutes

MAX power for more difficult tasks.

Radix Cyclone™ technology

Patented technology that doesn't lose suction as you vacuum.

Hygienic one-touch bin emptying

Just push the button to release the dirt.

Detachable long-reach wand

Reaches up high, down low and into awkward gaps.

Docking station

Recharges and stores the machine and attachments when not in use.

Remote charging

Battery can be recharged away from the machine and the docking station.



Crevice tool

For cleaning in tight gaps and narrow spaces.



Combination accessory tool

Nozzle converts to a brush tool for dusting.



Pivots for easier steering

Cleaner head pivots 180° without losing contact with the floor. No more awkward moves.



Powered by an ENERGY STAR qualified battery charger for a better environment

DC 35 animal

Up top, down below and in-between cleans in the home and car.



Motorised floor tool with carbon fibre brushes

Anti-static carbon fibre brushes clean hard floors. Rotating nylon brushes remove more dirt from carpets.



Mini motorised brush bar

Removes more pet hair and dirt from carpets and upholstery in the home and car.



DC 35 multi floor

Up top, down below and in-between.



Motorised floor tool with carbon fibre brushes

Anti-static carbon fibre brushes clean hard floors. Rotating nylon brushes remove more dirt from carpets.



**DC
34**



Twice the suction
Twice the suction of any other handheld in use.

LED battery indicator
Indicates battery charge level and diagnostic status.

Direct charging
Charger plugs directly into the battery - doesn't have to be attached to the machine.

Radix Cyclone™ technology
Patented Dyson technology that doesn't lose suction as you vacuum.



Lightweight and ergonomic
Balanced weight distribution for easy handling.

Dual power mode

15 minutes
High constant suction. (13 mins with motorised brush bar attached#).

6 minutes
MAX power for more difficult tasks.



Dyson digital motor
More powerful, using less energy than conventional motors. Creates the most power-efficient handheld.



Hygienic one-touch bin emptying
Just push the button, no need to touch the dirt.



Dual power mode
Max mode for intense cleaning.



Up to 3 times faster recharging
Lithium ion battery technology – recharges up to 3 times faster than others.

#DC34 Animal only.

DC 34 animal

High performance spot cleaning on carpets and upholstery in the home and car.



Mini motorised brush bar
Removes more pet hair and dirt from carpets and upholstery.



Crevice tool
For cleaning in tight gaps and narrow spaces.



Combination accessory tool
Nozzle converts to a brush tool for dusting.



DC 34

For high performance spot cleaning in the home and car.



Crevice tool
For cleaning in tight gaps and narrow spaces.



Combination accessory tool
Nozzle converts to a brush tool for dusting.



**DC
30**



For spot cleans in the home.

Lightweight and ergonomic

Balanced weight distribution for easy handling.

LED battery indicator

Indicates battery charge level and diagnostic status.



Combination accessory tool

Wide debris nozzle removes crumbs and large particles – converts to a brush tool for dusting.

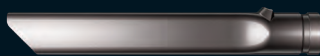

Crevice tool

For cleaning in tight gaps and narrow spaces.

Direct charging

Charger plugs directly into the battery - doesn't have to be attached to the machine.



Radix Cyclone™ technology

Patented Dyson technology that doesn't lose suction as you vacuum.



Dyson digital motor

More powerful, using less energy than conventional motors. Creates the most power-efficient handheld.



Hygienic one-touch bin emptying

Just push the button, no need to touch the dirt.



Up to 3 times faster recharging

Lithium ion battery technology – recharges up to 3 times faster than others.

Accessories

Dyson engineers have developed a range of tools to fit your Dyson vacuum cleaner. There's one for every kind of cleaning task.



Stubborn dirt brush

Ideal for cleaning mud and dried-in dirt from floors and upholstery. Fits all models.

RRP: \$29*

Part no. 918507



Mattress tool

Ideal for removing dirt and dust mite faeces from mattresses and upholstery. Fits all models.

RRP: \$29*

Part no. 908940



Up top tool

Twists to give multiple angles for cleaning hard to reach surfaces. Fits all models except handhelds.

RRP: \$49*

Part no. 917645



Soft dusting brush

Ideal for cleaning blinds and dusting around the home. Fits all models.

RRP: \$49*

Part no. 908877

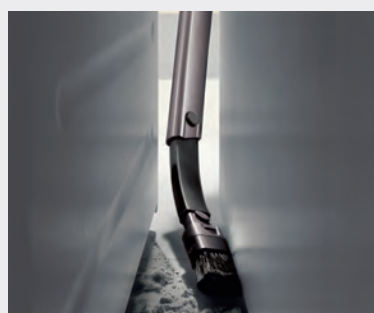

Flexi crevice tool

Extends and flexes into awkward gaps in the home or the car. Fits all models.

RRP: \$49*

Part no. 908032



Groom tool

Self cleans. Mess-free vacuum assisted dog grooming. Fits all models except DC01 and cordless models. (If you have a barrel motorhead model please contact Dyson Customer Care).

RRP: \$89*

Part no. 921000



Flat Out™ head

Super-low profile for easier cleaning under low furniture. Fits all models except cordless models.

RRP: \$49*

Part no. 914606



Swivel hard floor tool

Ideal for pick-up on hard floors. Fits all models except DC01, DC21 Motorhead, DC23 Motorhead and cordless models.

RRP: \$59*

Part no. 920018



Mini turbine head

Ideal for picking up pet hair from stairs and upholstery. Fits all models except DC01, DC02, DC03, DC24 and cordless models.

RRP: \$79*

Part no. 915022



Turbine head

For high dirt and pet hair pick-up from carpets. Fits all barrel models except DC02, DC05 Motorhead, DC08, DC19, DC22 and DC26.

RRP: \$129*

Part no. 911566



Tool kit

Ideal for cleaning the car and around the home. Kit includes: Stubborn dirt brush, Mini soft dusting brush, Mattress tool and Extendable hose reaching up to 1.1m. Fits all cordless models.

RRP: \$99*

Part no. 919648



Car cleaning kit

Three tools for a spotless car interior. Kit includes: Flexi crevice tool, Stubborn dirt brush and Mini turbine head. Fits all Dyson vacuums except DC01, DC02, DC03, DC24 and cordless models.

RRP: \$129*

Part no. 908909

All Dyson vacuum cleaners feature:

- No loss of suction as you vacuum
- Dyson's patented cyclone technology
- Captures allergens, expels cleaner air
- No ongoing costs – lifetime filters
- Suitable for all floor types
- 2 year guarantee
- 7 days a week Helpline 1800 239 766

BARRELS							
	DC 23 motorhead	DC 39 animal NEW	DC 39 allergy NEW	DC 39 multi floor NEW	DC 29 multi floor	DC 22 turbine	DC 26 hepa
Main floor tool							
Additional floor tool/s				Available at your local Dyson retailer and www.dyson.com.au the Dyson online shop			
	Brush, Crevice and Stair tools	Combination accessory tool and Stair tool	Combination accessory tool and Stair tool	Combination accessory tool and Stair tool	Combination accessory tool and Stair tool	Combination accessory tool and Stair tool	Combination accessory tool and Stair tool
What will you be using your vacuum cleaner for?							
Main clean of your home	●	●	●	●	●	●	●
A quick tidy up in-between your main cleans							
Spot cleaning							
What size home do you have?							
Large - a family home	●	●	●	●	●		
Medium - a villa or apartment						●	
Small - a studio or one bedroom flat							●
What performance do you need from your vacuum cleaner?							
High performance on carpets	●	●	●			●	
High performance on hard floors and tiles	●	●				●	●
A vacuum suitable for carpets and hard floors	●	●		●	●	●	●
If you have a dog or cat, what pet hair pick-up do you require?							
Best pet hair pick-up from carpets	●	●	●			●	
Improved pet hair removal from upholstery		●					
Additional features							
Approved by the National Asthma Council Australia	●	●	●	●	●	●	●
Wraps/compacts for easy storage	●					●	
Hygienic bin emptying	●	●	●	●	●	●	●
Ball™ technology - easy to manoeuvre		●	●	●			
Product number	15425-01	22412-01	22411-01	22410-01	21960-01	20580-01	18820-01

UPRIGHTS				HANDSTICKS		HANDHELDS		
DC 41 animal	DC 25 allergy	DC 24 hepa	DC 33 multi floor	DC 35 animal	DC 35 multi floor	DC 34 animal	DC 34	DC 30
NEW						15 minutes High constant suction. (13 mins with mini motorised brush bar attached*). 6 minutes MAX power for more difficult tasks.		
●	●	●	●	●	●	●	●	●
Motorised brush bar	Motorised brush bar	Motorised brush bar	Belt driven brush bar	Motorised floor tool	Motorised floor tool	Mini motorised brush bar	Combination accessory tool	Combination accessory tool
Combination floor tool and Mini turbine head	Combination floor tool and Mattress tool	Mini Flat Out™ head	Combination floor tool	Mini motorised brush bar	Combination accessory tool and Crevice tool	Combination accessory tool and Crevice tool	Crevice tool	Crevice tool
Combination accessory tool and Stair tool	Combination accessory tool and Stair tool	Combination accessory tool	Combination accessory tool and Stair tool	Combination accessory tool and Crevice tool				
●	●	●	●					
				●	●			
				●	●	●	●	●
●	●		●					
	●	●						
		●						
●	●	●	●	●	●	●		
●	●	●	●	●	●	●	●	●
●	●	●	●	●	●	●	●	●
●	●	●	●	●	●	●		
●	●	●	●	●	●	●		
●	●	●	●	●	●	●		
●	●	●	●	●	●	●		
●	●	●	●	●	●	●		
●	●	●	●	●	●	●		
●	●	●	●	●	●	●		
20283-01	22366-01	15099-01	22075-01	22157-01	20561-01	21502-01	21499-01	17993-01

*Dyson's recommended retail prices correct as at November 2011 but subject to change.
 *Mini motorised brush bar available with DC34 Animal only.



Dyson Helpline

The majority of calls are resolved over the phone, first time around.

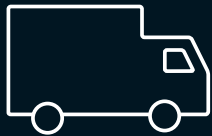

Machine delivery

Return to any home or work address.



Machine collection

If the problem can't be solved over the phone, Dyson will collect the machine from any address, home or work.

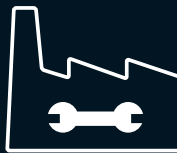

Dyson engineers

The problem is diagnosed and solved within 72 hours.



Australia's No.1 trusted brand
Home Appliances category



Australia's No.1 vacuum cleaner
brand since 2007.
(Based on unit sales JAN 2007 - DEC 2010)

Dyson is committed to the highest standard of customer service. Every Dyson vacuum cleaner comes with a 2 year parts and labour guarantee. In the unlikely event of there being a problem, Dyson customer service centre will collect, repair and return the machine anywhere in Australia. They don't just solve problems though. You can get cleaning tips, advice about Dyson accessories or find out about new technology from Dyson.



1800 239 766 www.dyson.com.au

Monday - Friday 8:00am to 6:00pm EST

Saturday - Sunday 8:30am to 4:00pm EST



The cleaner that doesn't lose suction.