

Installation instructions and User guide

Induction cooktop

CI604DT, CI754DT, and CI905DT models

NZ AU GB IE



Safety and warnings	2
Installation instructions	6
Introduction	12
Choosing the right cookware	14
Using your induction cooktop	15
Using your cooktop's special features	18
Cooking guidelines	28
Care and cleaning	30
Troubleshooting	31
Warranty and service	33

Important!

SAVE THESE INSTRUCTIONS

The models shown in this user guide may not be available in all markets and are subject to change at any time. For current details about model and specification availability in your country, please visit our local website listed on the back cover or contact your local Fisher & Paykel dealer.

2 Safety and warnings

Your safety is important to us. Please read this information before using your cooktop.

Installation

WARNING!



Electrical Shock Hazard

Disconnect the appliance from the mains electricity supply before carrying out any work or maintenance on it.

Connection to a good earth wiring system is essential and mandatory. Alterations to the domestic wiring system must only be made by a qualified electrician.

Failure to follow this advice may result in electrical shock or death.

WARNING!



Cut Hazard

Take care - panel edges are sharp.

Failure to use caution could result in injury or cuts.

Important safety instructions

- *Read these instructions carefully before installing or using this appliance.*
- *No combustible material or products should be placed on this appliance at any time.*
- *Please make this information available to the person responsible for installing the appliance as it could reduce your installation costs.*
- *In order to avoid a hazard, this appliance must be installed according to these instructions for installation.*
- *This appliance is to be properly installed and earthed only by a suitably qualified person.*
- *This appliance should be connected to a circuit which incorporates an isolating switch providing full disconnection from the power supply.*
- *Failure to install the appliance correctly could invalidate any warranty or liability claims.*

Operation and maintenance

⚠ WARNING!**Electrical Shock Hazard**

Do not cook on a broken or cracked cooktop. If the cooktop surface should break or crack, switch the appliance off immediately at the mains power supply (wall switch) and contact a qualified technician.

Switch the cooktop off at the wall before cleaning or maintenance.

Failure to follow this advice may result in electrical shock or death.

⚠ WARNING!**Health Hazard**

This appliance complies with electromagnetic safety standards. However, persons with cardiac pacemakers or other electrical implants (such as insulin pumps) must consult with their doctor or implant manufacturer before using this appliance to make sure that their implants will not be affected by the electromagnetic field.

Failure to follow this advice may result in death.

⚠ WARNING!**Hot Surface Hazard**

During use, accessible parts of this appliance will become hot enough to cause burns.

Do not let body, clothing or any item other than suitable cookware contact with the ceramic glass until the surface is cool.

Never leave metal objects (such as kitchen utensils) or empty pans on the cooktop as they can become hot very quickly.

Beware: magnetisable metal objects worn on the body may become hot in the vicinity of the cooktop. Gold or silver jewellery will not be affected.

Keep children away.

Handles of saucepans may be hot to touch. Check saucepan handles do not overhang other cooking zones that are on. Keep handles out of reach of children.

Failure to follow this advice could result in burns and scalds.

! WARNING!**Cut Hazard**

The razor-sharp blade of a cooktop scraper is exposed when the safety cover is retracted. Use with extreme care and always store safely and out of reach of children.

Failure to use caution could result in injury or cuts.

Important safety instructions

- *Never leave the appliance unattended when in use. Boilover causes smoking and greasy spillovers that may ignite.*
- *Never use your appliance as a work or storage surface.*
- *Never leave any objects or utensils on the appliance.*
- *Do not place or leave any magnetisable objects (eg credit cards, memory cards) or electronic devices (eg computers, MP3 players) near the appliance, as they may be affected by its electromagnetic field.*
- *We recommend using plastic or wooden kitchen utensils for cooking with your induction cooktop.*
- *Never use your appliance for warming or heating the room.*
- *After use, always turn off the cooking zones and the cooktop as described in this manual (ie by using the touch controls). Do not rely on the pan detection feature to turn off the cooking zones when you remove the pans.*
- *Do not allow children to play with the appliance or sit, stand, or climb on it.*
- *Do not store items of interest to children in cabinets above the appliance. Children climbing on the cooktop could be seriously injured.*
- *Do not leave children alone or unattended in the area where the appliance is in use.*
- *Children or persons with a disability which limits their ability to use the appliance should have a responsible and competent person to instruct them in its use. The instructor should be satisfied that they can use the appliance without danger to themselves or their surroundings.*
- *Do not repair or replace any part of the appliance unless specifically recommended in the manual. All other servicing should be done by a qualified technician.*
- *Do not use a steam cleaner to clean your cooktop.*
- *Do not place or drop heavy objects on your cooktop.*
- *Do not stand on your cooktop.*
- *Do not use pans with jagged edges or drag pans across the ceramic glass surface as this can scratch the glass.*
- *Do not use scourers or any other harsh/abrasive cleaning agents to clean your cooktop, as these can scratch the ceramic glass.*
- *If the power supply cable is damaged, it must only be replaced by a qualified technician.*
- *Do not operate your cooktop by means of an external timer or separate remote-control system.*

6 Installation instructions

Cooktop and cutout dimensions

Electrical connection is made at the right rear

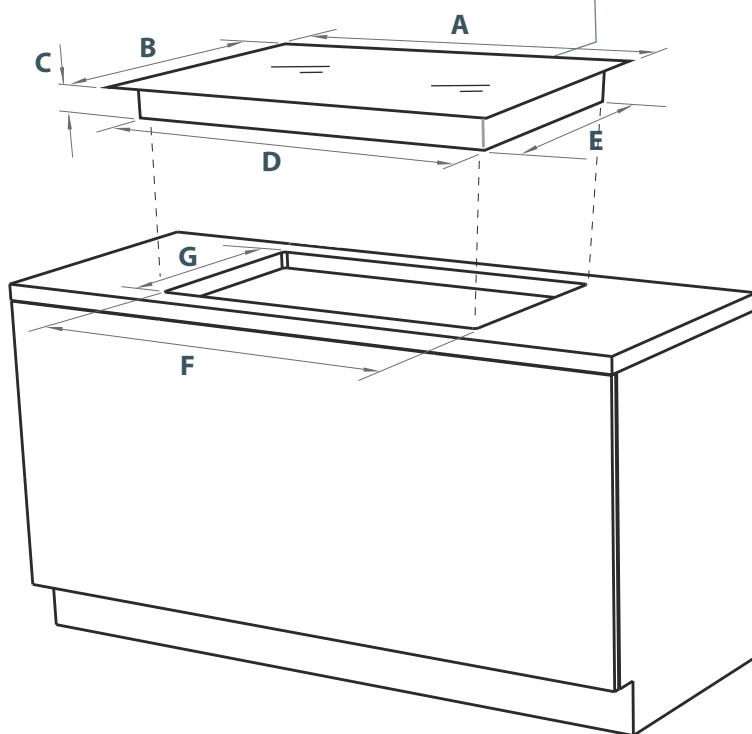

Cooktop and cutout dimensions (mm)

		CI604DT	CI754DT	CI905DT
A	overall width of cooktop	600	750	900
B	overall depth of cooktop	530	530	530
C	height of chassis (plastic housing incl. terminal block) below top of bench	50	50	50
D	width of chassis (metal frame)	546	716	852
E	depth of chassis (metal frame)	476	476	482
F	overall width of cutout	560	725	870
G	overall depth of cutout	490	490	494

Clearances

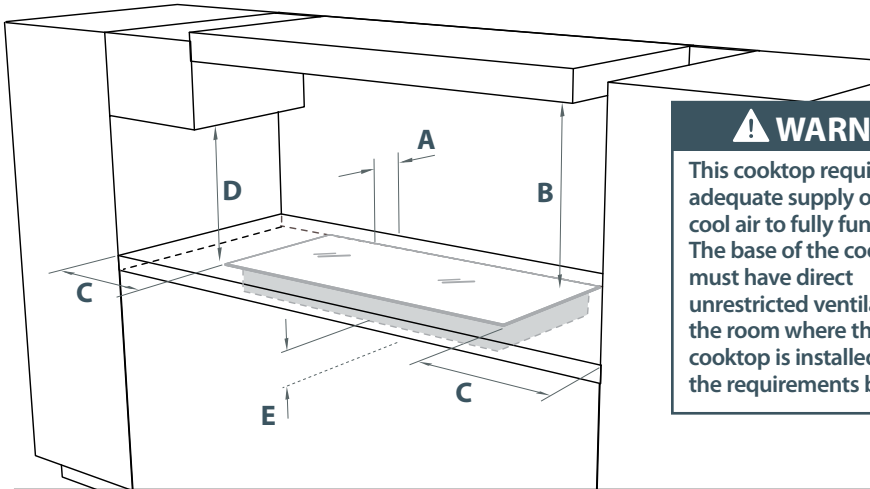

⚠ WARNING!
 This cooktop requires adequate supply of fresh, cool air to fully function. The base of the cooktop must have direct unrestricted ventilation to the room where the cooktop is installed. Follow the requirements below.

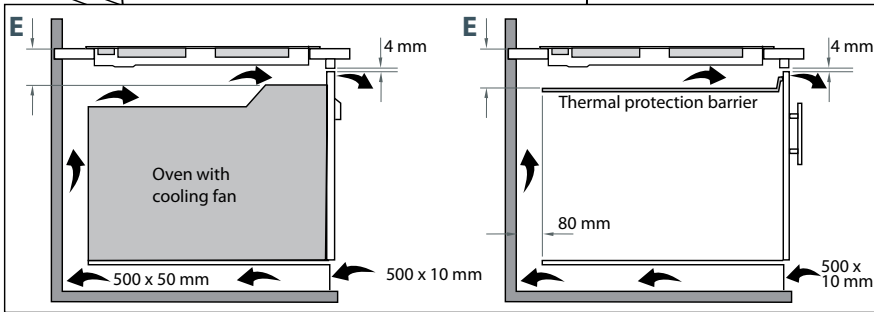

Fig. 1 Minimum clearances and ventilation requirements - oven installed below cooktop

Fig. 2 Minimum clearances and ventilation requirements - cupboard or drawer space below

Clearances (mm)

	C1604DT	C1754DT	C1905DT
A	55	55	53
B	650	650	650
C	85	78	80
D	450	450	450
E	90	90	90
	75	75	75

* The oven installed below the cooktop MUST have a cooling fan.

Installation instructions

Before you install the cooktop, make sure that

- the benchtop is square and level, and no structural members interfere with space requirements
- the benchtop is made of a heat-resistant material
- the cooktop will not be installed directly above a dishwasher, fridge, freezer, washing machine or clothes dryer, as the humidity may damage the cooktop electronics
- if the cooktop is installed above an oven, the oven has a built-in cooling fan
- the installation will comply with all clearance requirements and applicable standards and regulations
- a suitable isolating switch providing full disconnection from the mains power supply is incorporated in the permanent wiring, mounted and positioned to comply with the local wiring rules and regulations. The isolating switch must be of an approved type and provide a 3 mm air gap contact separation in all poles (or in all active [phase] conductors if the local wiring rules allow for this variation of the requirements)
- the isolating switch will be easily accessible to the customer with the cooktop installed
- you consult local building authorities and by-laws if in doubt regarding installation
- you use heat-resistant and easy-to-clean finishes (such as ceramic tiles) for the wall surfaces surrounding the cooktop.

When you have installed the cooktop, make sure that

- the power supply cable is not accessible through cupboard doors or drawers
- there is adequate flow of fresh air from outside the cabinetry to the base of the cooktop
- if the cooktop is installed above a drawer or cupboard space, a thermal protection barrier is installed below the base of the cooktop
- the isolating switch is easily accessible by the customer
- you complete the 'Final checklist' at the end of these installation instructions.

The thermal protection barrier must be:

- removable
- heat-resistant
- made from low thermal conductivity material
- at least 25 mm below the plastic housing of the cooktop chassis

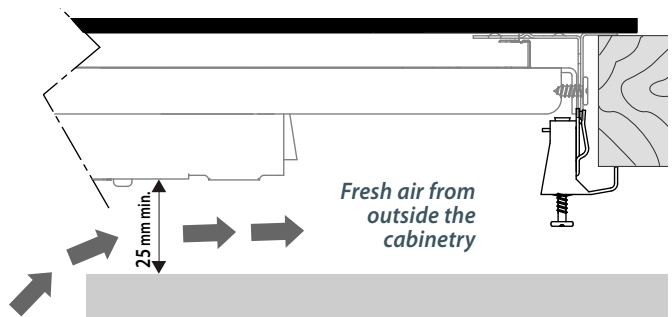

Fig. 3 Thermal protection barrier

Connecting the cooktop to the mains power supply

Important!

- *This cooktop must be connected to the mains power supply only by a suitably qualified person.*
- Before connecting the cooktop to the mains power supply, check that:
 - 1 the domestic wiring system is suitable for the power drawn by the cooktop.
 - 2 the voltage corresponds to the value given in the rating plate
 - 3 the power supply cable sections can withstand the load specified on the rating plate.
- To connect the cooktop to the mains power supply, do not use adapters, reducers, or branching devices, as they can cause overheating and fire.
- The power supply cable must not touch any hot parts and must be positioned so that its temperature will not exceed 75°C at any point.

Power supply

CI604DT 6950W @220-240/380-415V 2N~ (30A)

CI754DT 7400W @220-240/380-415V 2N~ (32A)

CI905DT 9800W @220-240/380-415V 3N~ (42A)

Important!

- *Check with an electrician whether the domestic wiring system is suitable without alterations. Any alterations must only be made by a qualified electrician.*

Connection diagrams

CI604DT, CI754DT

*Single-phase connection
220-240V~*

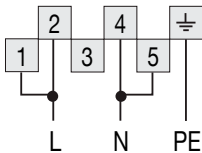

*Two-phase connection
380-415V 2N~*

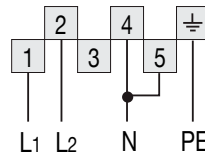

CI905DT

*Single-phase connection
220-240V~*

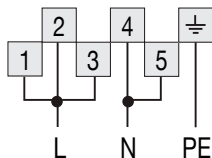

*Three-phase connection
380-415V 3N~*

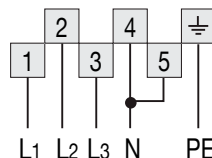

Applying the supplied foam seal

- 1 Turn the cooktop upside down and place it carefully on a soft surface.

Important!

To avoid damage to the glass, ensure there is a protective cover underneath it.

- 2 Apply the foam seal around the glass overhang, 5 mm in from the edge of the glass.
- 3 Turn the cooktop the right way up and place it into the cutout.

Clamping down the cooktop

- Depending on the thickness of the benchtop, secure the supplied clamping brackets as shown.

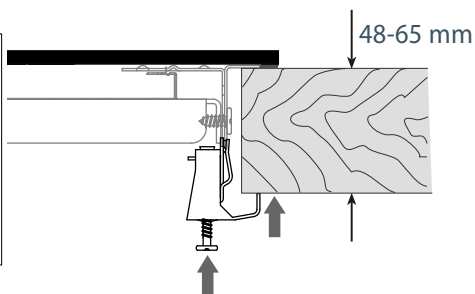
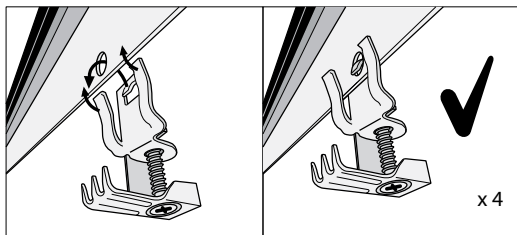

Important!

Do not overtighten the screws!

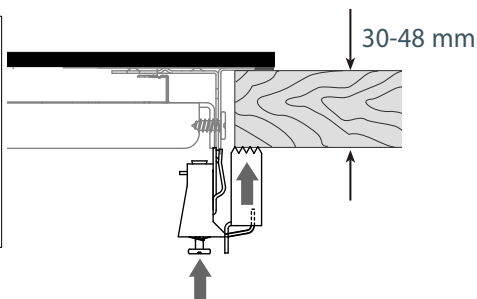
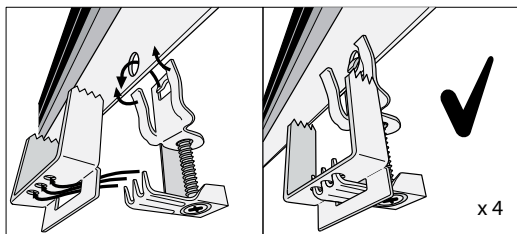

Important!

Do not overtighten the screws!

Final checklist

TO BE COMPLETED BY THE INSTALLER



- Is the cooktop earthed?
- Check that there is an adequate and constant flow of fresh air from outside the cabinetry to the base of the cooktop.
- Check that the power supply cable is not accessible via cupboard doors or drawers.
- Is the cooktop clamped down securely?
- Check that the pan detection feature is working correctly. Turn on each cooking zone without putting any cookware on them. Are all the displays flashing $\underline{\quad}$?
- Check that all the cooking zones function correctly. Place suitable pans with water in them on each zone, then turn all of them on to a high setting. Is the water heating?
- Are all touch controls and displays functioning?
- To check that the 'hot surface' indicators function correctly, turn off all the zones. Is H displayed in all the cooking zone displays?
- Have you shown the customer how to use the cooktop? Make sure you explain to the customer about:
 - the importance of taking note of the safety warnings at the beginning of this manual, especially for persons with cardiac pacemakers or other electrical implants
 - the 'hot surface' indicators (H)
 - using induction-suitable cookware only
 - the pan detection feature ($\underline{\quad}$).

Installer's name: _____

Installer's signature: _____

Installation company: _____

Date of installation: _____

LEAVE THESE INSTRUCTIONS WITH THE CUSTOMER

Introducing your cooktop

Congratulations on your new purchase. Your Fisher & Paykel induction cooktop is the ultimate in induction cooking, giving you the speed, precision, and simplicity of electronic control, and the easy-care elegance of a ceramic glass surface. For more information, visit our local website listed on the back cover.

A word on induction cooking

Induction cooking is a safe, advanced, efficient, and economical cooking technology. It works by electromagnetic vibrations generating heat directly in the pan, rather than indirectly through heating the glass surface. The glass becomes hot only because the pan eventually warms it up. This technology has a number of advantages over traditional radiant energy cooking:

- Heat-up times are much faster.
- Use is safer as no heating takes place unless a suitable pan is placed on the cooking zone.
- As heat is transferred without loss, you save energy.

Before using your new cooktop

- Read this guide, taking special note of the 'Safety and warnings' section.
- Remove any protective film that may still be on your cooktop.

Using the touch controls

- The controls respond to touch, so you don't need to apply any pressure.
- Use the ball of your finger, not its tip.
- You will hear a beep each time a touch is registered.
- Make sure the controls are always clean, dry, and there is no object (eg a utensil or a cloth) covering them. Even a thin film of water may make the controls difficult to operate.

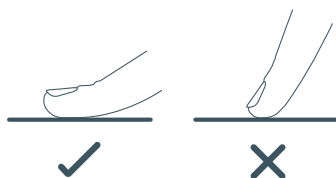

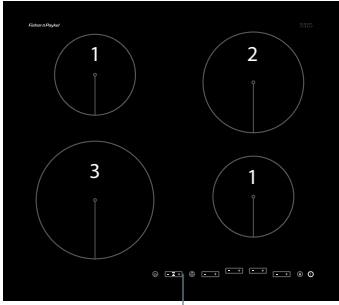

6 Fig.4 CI604DT model

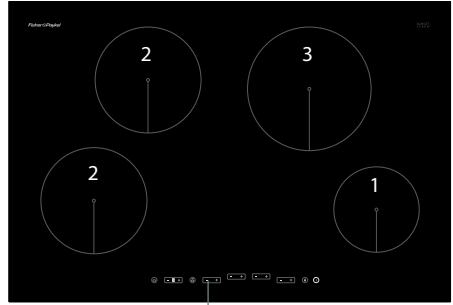

6 Fig.5 CI754DT model

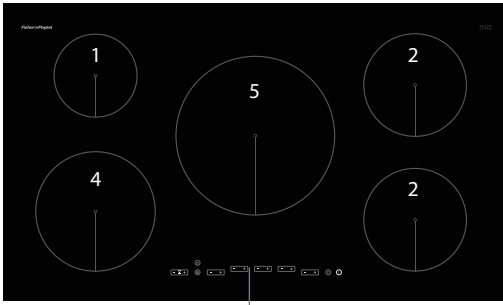

6 Fig.6 CI905DT model

- 1 1400 W (1800W*) zone
- 2 1850 W (2500W*) zone
- 3 2300 W (3700W*) zone
- 4 2300 W (3200W*) zone
- 5 2400 W (3700W*) zone
- 6 Touch controls

* Maximum power output when set for PowerBoost See 'Using your cooktop's special features.'

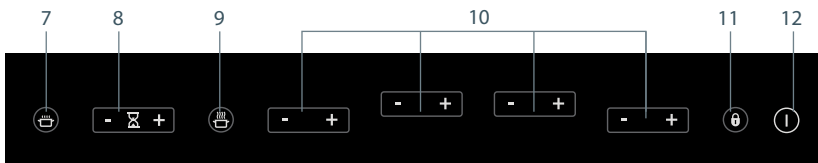

Fig.7 Touch controls for CI604DT and CI754DT models

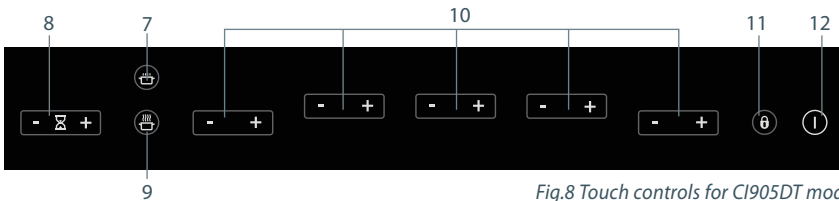



Fig.8 Touch controls for CI905DT model

- 7 GentleHeat control
- 8 Timer control
- 9 PowerBoost control
- 10 Heat setting controls
- 11 Keylock control
- 12 ON/OFF control

14 Choosing the right cookware

Important!

- Only use cookware with a base suitable for induction cooking. Look for the induction symbol on the packaging or the bottom of the pan.
- You can check whether your cookware is suitable by carrying out a magnet test. Move a magnet towards the base of the pan. If it is attracted, the pan is suitable for induction.
- If you do not have a magnet:
 - 1 Put some water in the pan you want to check.
 - 2 Follow the steps under 'To start cooking' opposite.
 - 3 If  does not flash in the display and the water is heating, the pan is suitable.
- Cookware made from the following materials is not suitable: pure stainless steel, aluminium or copper without a magnetic base, glass, wood, porcelain, ceramic, earthenware.

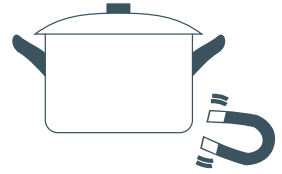

Do not use cookware with jagged edges or a curved base.

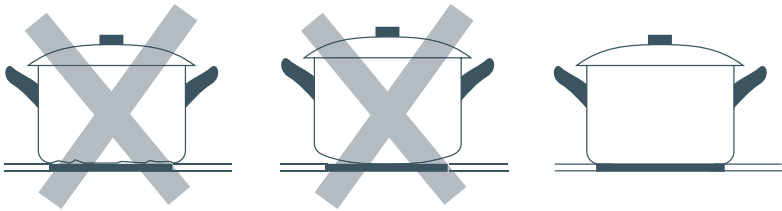

Make sure that the base of your pan is smooth, sits flat against the glass, and is the same size as the cooking zone. Always centre your pan on the cooking zone.

Note: for CI905DT models: the large middle cooking zone may also be used successfully with pans whose base is somewhat smaller than the zone.

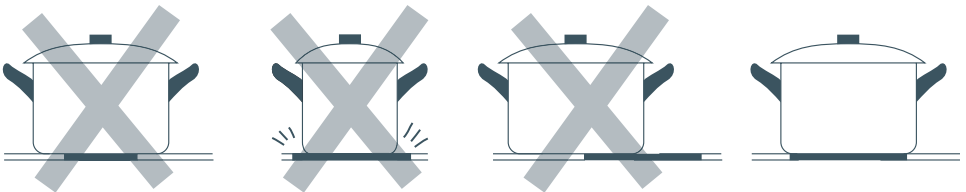

Always lift pans off the cooktop– do not slide, or they may scratch the glass.

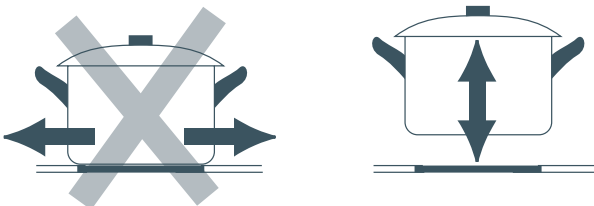

To start cooking

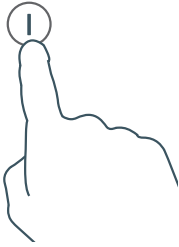

- 1 Touch and hold the ON/OFF control for 2 seconds.



- 2  will appear in the cooking zone displays.

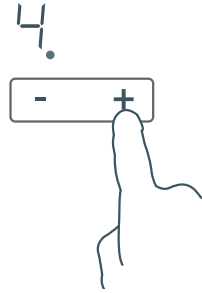
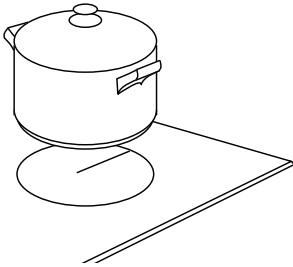

- 3 Place a suitable pan on the cooking zone you wish to use.
 - Make sure the bottom of the pan and the surface of the cooking zone are clean and dry.
- 4 Select a heat setting by touching – or + .
 - If you don't choose a heat setting within 10 seconds, the cooktop will automatically turn off. Start with step 1 again.
 - You can modify the heat setting at any time during cooking.

If a display flashes alternately with the heat setting

This means that:

- you have not placed a pan on the correct cooking zone *or*
- the pan you're using is not suitable for induction cooking *or*
- the pan is too small or not properly centred on the cooking zone.



No heating takes place unless there is a suitable pan on the cooking zone. The cooktop will automatically turn off after 10 minutes if no suitable pan is placed on it.

16 Using your induction cooktop

When you have finished cooking



- 1a Turn the cooking zone off by scrolling down to 0 or touching – and + together. Make sure the display shows 0.

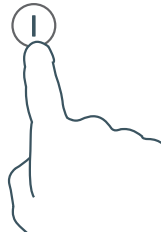

- 1b Turn the whole cooktop off by touching the ON/OFF control.

2 Beware of hot surfaces

H will show which cooking zone is too hot to touch. It will disappear when the surface has cooled down to a safe temperature.



Locking the controls

- You can lock the controls to prevent unintended use (for example children accidentally turning cooking zones on).
- When the controls are locked, all controls except the ON/OFF control are disabled.

To lock the controls

- 1 Make sure that the cooktop is turned on but no cooking zone is in use.
- 2 Touch and hold the keylock control  for 2 seconds. The red light above the control comes on, indicating that the controls are locked.
- Note: the cooktop will automatically turn off after 10 seconds, but the controls will still be locked when you turn the cooktop on again.

To unlock the controls

- 1 Make sure the cooktop is turned on.
- 2 Touch and hold the keylock control  for 2 seconds. The red light above the control goes out.
- 3 You can now start using your cooktop.

Important!

Do not lock the controls while a cooking zone is in use. If you do, you can always turn the cooktop off with the ON/OFF control in an emergency.

Using the PowerBoost feature

This feature enables you to sear meat or bring liquid to the boil very quickly. When a cooking zone is set for PowerBoost, it uses more than 100% of the power of that particular cooking zone, resulting in a boost of intense heat.

Important!

PowerBoost heats food and liquids very quickly. Do not leave the cooktop unattended when using this feature.

To set a cooking zone for PowerBoost

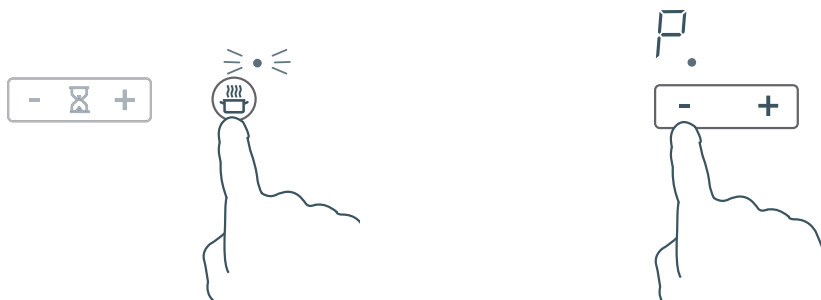

- 1 With the cooktop turned on, touch the PowerBoost control . The flashing red light indicates that PowerBoost is ready to be set.
- 2 Within 5 seconds, touch the – or + control of a cooking zone once. Its display will show P.

When PowerBoost is set

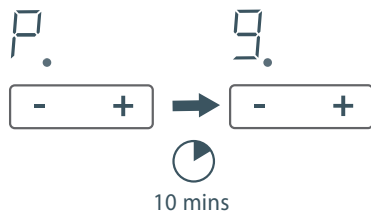

- The cooking zone will be on PowerBoost (more than 100%) for **10 minutes**, and then automatically reduce the heat to setting 9 (100%).

To quit the PowerBoost setting

Touch the – control of the cooking zone at any time and select a new setting or turn the cooking zone off.

Note:

- You can set two (CI604DT and CI754DT) or three (CI905DT) cooking zones for PowerBoost, as long as one is not behind the other. For example:

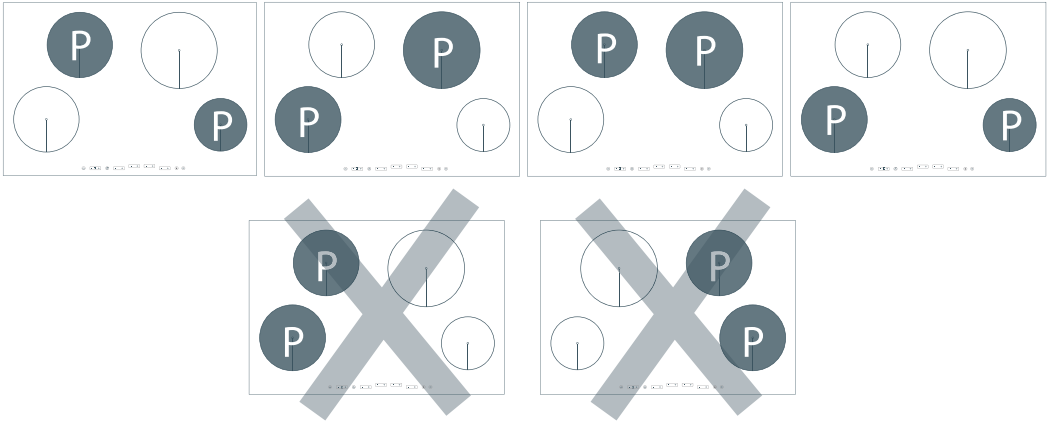

- If you wish to set more than one cooking zone for PowerBoost, you need to set them separately.
- When a cooking zone is set for PowerBoost, the cooking zone immediately in front of or behind it may have to reduce its power level.

Using the GentleHeat feature

This feature is ideal for the most delicate cooking tasks (such as melting chocolate), as the cooking zone will provide continuous gentle heat (between heat setting levels \square and $?$).

To set a cooking zone for GentleHeat



- With the cooktop turned on, touch the GentleHeat control. The flashing red light indicates that GentleHeat is ready to be set.

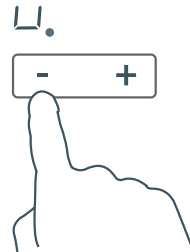

- Within 5 seconds, touch the - or + control of a cooking zone. Its display will show \square .

To quit the GentleHeat setting

Touch the + control of the cooking zone at any time and select a new setting or turn the cooking zone off.

20 Using your cooktop's special features

Using the Auto Heat-reduce feature

Cooking zones set for this feature will:

- first quickly heat up food or liquid at the highest setting
- then automatically reduce the heat to a pre-selected lower setting to cook the food through.

To set a cooking zone for Auto Heat-reduce

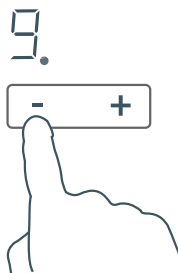

- 1 With the cooktop turned on, touch the - control of a cooking zone. The display will show 9.

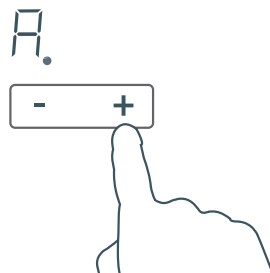

- 2 Touch +. The letter A will start flashing alternately with 9.

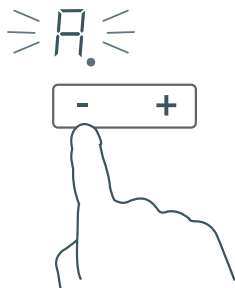

- 3 Touch - briefly and then select the heat setting you want the cooking zone to automatically reduce to (1-8).

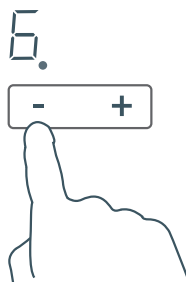

When Auto Heat-reduce is set



Initially, while the cooking zone is at the highest setting, **A** will flash alternately with your selected lower setting. The length of time at the highest setting depends on the lower heat setting selected. See chart below.



Then, when the period of highest setting is over, **A** will stop flashing and the cooking zone will automatically reduce the heat to your pre-selected lower setting.

- To increase the lower heat setting while **A** is flashing, simply touch + .
- If you would like a lower or higher heat setting than you originally selected, touch – and + together and set the cooking zone for Auto Heat-reduce again. Alternatively, wait until **A** stops flashing and then modify the heat setting.

Pre-selected lower heat setting	Length of time at highest setting
1	40 seconds
2	1 minute
3	2 minutes
4	3 minutes
5	4 minutes
6	7 minutes
7	2 minutes
8	3 minutes

To quit the Auto Heat-reduce setting while **A** is flashing

Touch the – and + controls of the corresponding cooking zone together.

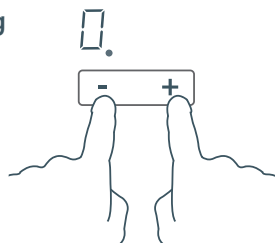

Note:

- The Auto Heat-reduce and PowerBoost features cannot be used together. If you turn PowerBoost on when Auto Heat-reduce is already set, the latter will be immediately cancelled and PowerBoost will be activated instead.

Using the timer

You may use the timer in two different ways:

- You can use it as a minute minder. In this case, the timer will not turn any cooking zone off when the set time is up.
- You can set it to turn one or more cooking zones off after the set time is up.
- You can set the timer for up to 99 minutes.

Timer overview

Cooking zone indicator for middle zone (CI905DT models only)

Cooking zone indicators show you which cooking zone(s) the timer is set for. In this illustration, the timer is set for all the cooking zones.

A flashing indicator shows you what setting is being shown in the minute display. In this illustration, the remaining time set for the left front cooking zone is 31 minutes.

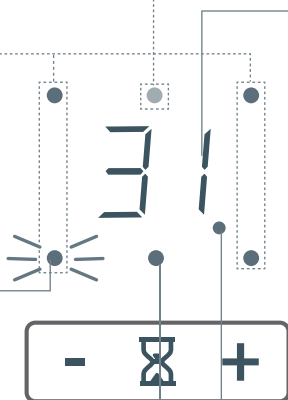

Minute minder indicator shows if the minute minder is set. It operates independently of any cooking zone.

Minute display shows the number of minutes set/remaining for:

- the cooking zone whose indicator is flashing
- OR**
- the minute minder, if its indicator is flashing.

If you set different times for multiple cooking zones, the minute display will revert to showing the shortest remaining time (with the corresponding indicator light flashing).

You can set or modify the number of minutes while this light is on.

Using the timer as a minute minder

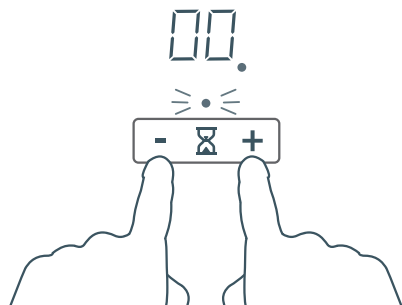

- 1 Make sure the cooktop is turned ON.
Note: you can use the minute minder even if you're not using any cooking zones.
- 2 Touch the – and + controls of the timer together. The minute minder indicator will start flashing and 00 will show in the minute display.

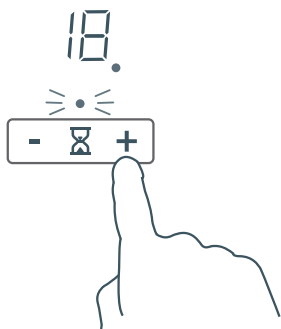

- 3 Set the time while the small red light in the bottom corner of the minute display is on.
 - Hint: the minutes will scroll faster if you touch and hold – or + continuously.
- 4 When the time is set, it will begin to count down immediately. The display will show the remaining time and the minute minder indicator will keep flashing.

If you are not using any cooking zones

You can use the timer as a minute minder even if you are not using any cooking zones. In this case, the cooktop will turn itself off 10 seconds after you have set the time, but the time will continue to count down. To change or cancel the minute minder setting, you will have to turn the cooktop back on first. See 'To change or cancel a timer setting'.

When the set time is up

00 will flash and the timer will beep. Touch any control to stop the beeping. Remember, touching the ON/OFF control will turn the whole cooktop off!

24 Using your cooktop's special features

Setting the timer to turn one or more cooking zones off

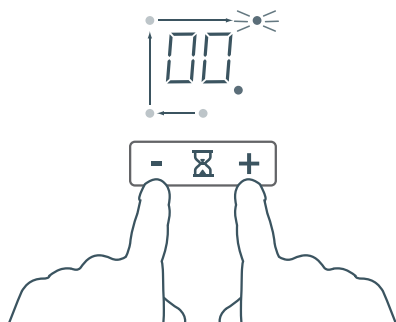

- 1 Make sure the cooking zone(s) you want to set the timer for are in use.
- 2 Touch the – and + controls of the timer together. Repeat until the indicator of the desired cooking zone comes on flashing.
 - Note: only indicators of cooking zones in use will show as you scroll through.

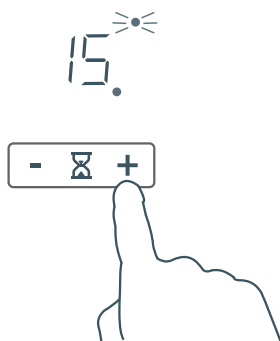

- 3 Set the time while the small red light in the bottom corner of the minute display is on. The timer is now set for the right rear cooking zone.

Setting the timer to turn one or more cooking zones off

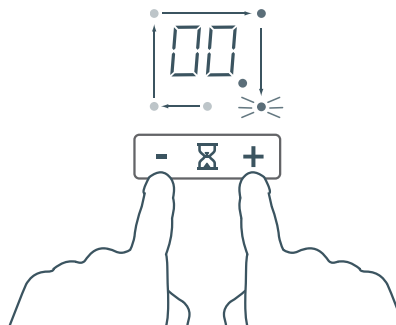

You may now continue to set the timer for additional cooking zones:

- 4 Touch the – and + controls of the timer together. Repeat until the indicator of the desired cooking zone comes on flashing.
- Note: the indicator of the cooking zone previously set will be steadily lit, showing you that the timer is set and counting down for that cooking zone.



- 5 Set the time while the small red light in the bottom corner of the minute display is on.

You can set different times for each of the cooking zones.

26 Using your cooktop's special features

When the timer is set



If the timer is set for more than one cooking zone, only the indicator belonging to the cooking zone with the shortest remaining time setting will flash.



To check the remaining time for another cooking zone:

Touch the – and + controls of the timer together and repeat until the indicator of the desired cooking zone is flashing.

When the set time is up



- The cooking zone whose set time is up will automatically turn off.
-  will flash in the minute display.
- The timer will beep.
Touch any control to stop the beeping.
The indicator of the relevant cooking zone will go out.

If the timer is still set and counting down for another cooking zone

The indicator belonging to the cooking zone with the shortest remaining time setting will flash.

To change or cancel a timer setting

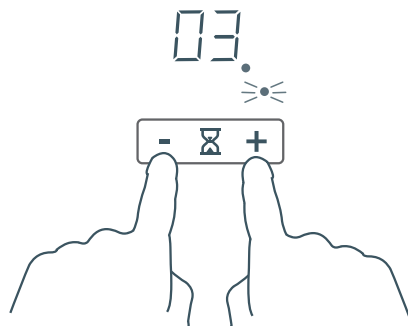

- 1 With the cooktop turned on, touch the – and + controls of the timer together and repeat until:
 - the indicator of the desired cooking zone or the minute minder indicator is flashing and
 - the small red light in the bottom corner of the minute display is on.

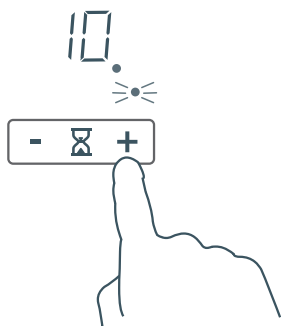

- 2 *To change:*
Set the new time while the small red light at the bottom of the minute display is on. **OR**



- 2 *To cancel:*
Touch the – control of the timer and repeat until the minute display shows 00.

Important!

Take care when frying: oil and fat heat up very quickly, particularly if you're using PowerBoost. At extremely high temperatures oil and fat will ignite spontaneously and this presents a serious fire risk.

Cooking tips

- When food comes to the boil, reduce the temperature setting.
- Using a lid will reduce cooking times and save energy by retaining the heat.
- Minimise the amount of liquid or fat to reduce cooking times.
- Start cooking on a high setting and reduce the setting when the food has heated through.

Simmering, cooking rice

- Simmering occurs below boiling point, at around 85 °C, when bubbles are just rising occasionally to the surface of the cooking liquid. It is the key to delicious soups and tender stews because the flavours develop without overcooking the food. You should also cook egg-based and flour-thickened sauces below boiling point.
- Some tasks, including cooking rice by the absorption method, may require a setting higher than the lowest setting to ensure the food is cooked properly in the time recommended.

Searing steak

To cook juicy flavoursome steaks:

- 1 Stand the meat at room temperature for about 20 minutes before cooking.
- 2 Heat up a heavy-based frying pan.
- 3 Brush both sides of the steak with oil. Drizzle a small amount of oil into the hot pan and then lower the meat onto the hot pan.
- 4 Turn the steak only once during cooking. The exact cooking time will depend on the thickness of the steak and how cooked you want it. Times may vary from about 2 – 8 minutes per side. Press the steak to gauge how cooked it is – the firmer it feels the more 'well done' it will be.
- 5 Leave the steak to rest on a warm plate for a few minutes to allow it to relax and become tender before serving.

For stir-frying

- 1 Choose an induction compatible flat-based wok or a large frying pan.
- 2 Have all the ingredients and equipment ready. Stir-frying should be quick. If cooking large quantities, cook the food in several smaller batches.
- 3 Preheat the pan briefly and add two tablespoons of oil.
- 4 Cook any meat first, put it aside and keep warm.
- 5 Stir-fry the vegetables. When they are hot but still crisp, turn the cooking zone to a lower setting, return the meat to the pan and add your sauce.
- 6 Stir the ingredients gently to make sure they are heated through.
- 7 Serve immediately.

Heat settings

The settings below are guidelines only. The exact setting will depend on several factors, including your cookware and the amount you are cooking. Experiment with the cooktop to find the settings that best suit you.

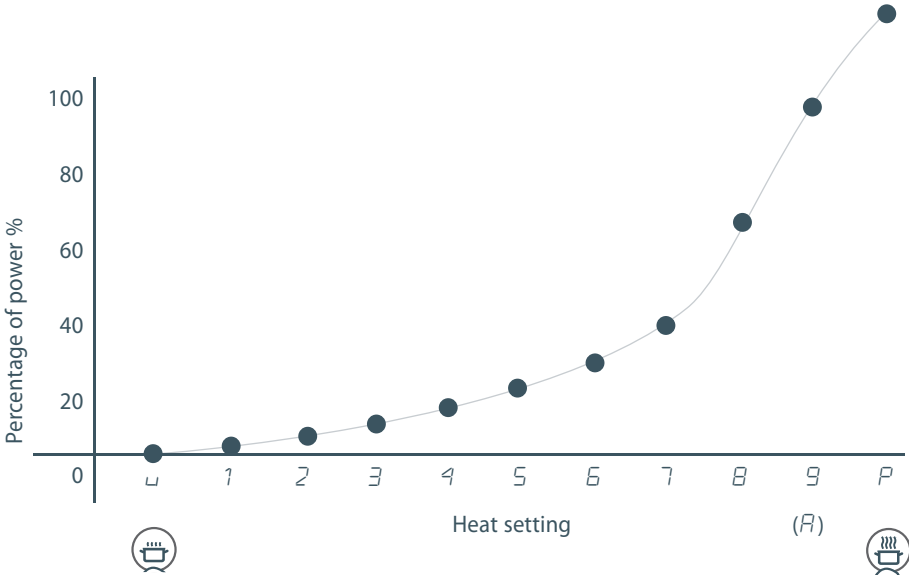

Heat setting	Suitability
0	<ul style="list-style-type: none"> ■ delicate warming for small amounts of food ■ melting chocolate, butter, and foods that burn quickly
1 - 2	<ul style="list-style-type: none"> ■ gentle simmering ■ slow warming
3 - 4	<ul style="list-style-type: none"> ■ reheating ■ rapid simmering ■ cooking rice
5 - 6	<ul style="list-style-type: none"> ■ pancakes
7 - 8	<ul style="list-style-type: none"> ■ sautéing ■ cooking pasta
9	<ul style="list-style-type: none"> ■ stir-frying ■ searing ■ bringing soup to the boil
P	<ul style="list-style-type: none"> ■ boiling water

What?	How?	Important!
<p>Everyday soiling on glass (fingerprints, marks, stains left by food or non-sugary spillovers on the glass)</p>	<ol style="list-style-type: none"> 1 Switch the power to the cooktop off at the wall. 2 Apply cooktop cleaner while the glass is still warm (but not hot!) 3 Rinse and wipe dry with a clean cloth or paper towel. 4 Switch the power to the cooktop back on at the wall. 	<ul style="list-style-type: none"> ▪ <i>When the power to the cooktop is switched off, there will be no 'hot surface' indication but the cooking zone may still be hot! Take extreme care.</i> ▪ <i>Heavy-duty scourers, some nylon scourers and harsh/abrasive cleaning agents may scratch the glass. Always read the label to check if your cleaner or scourer is suitable.</i> ▪ <i>Never leave cleaning residue on the cooktop: the glass may become stained.</i>
<p>Boilovers, melts, and hot sugary spills on the glass</p>	<p>Remove these immediately with a fish slice, palette knife or razor blade scraper suitable for ceramic glass cooktops, but beware of hot cooking zone surfaces:</p> <ol style="list-style-type: none"> 1 Switch the power to the cooktop off at the wall. 2 Hold the blade or utensil at a 30° angle and scrape the soiling or spill to a cool area of the cooktop. 3 Clean the soiling or spill up with a dish cloth or paper towel. 4 Follow steps 2 to 4 for 'Everyday soiling on glass' above. 	<ul style="list-style-type: none"> ▪ <i>Remove stains left by melts and sugary food or spillovers as soon as possible. If left to cool on the glass, they may be difficult to remove or even permanently damage the glass surface.</i> ▪ <i>Cut hazard: when the safety cover is retracted, the blade in a scraper is razor-sharp. Use with extreme care and always store safely and out of reach of children.</i>
<p>Spillover on the touch controls</p>	<ol style="list-style-type: none"> 1 Switch the power to the cooktop off at the wall. 2 Soak up the spill 3 Wipe the touch control area with a clean damp sponge or cloth. 4 Wipe the area completely dry with a paper towel. 5 Switch the power to the cooktop back on at the wall. 	<ul style="list-style-type: none"> ▪ <i>The cooktop may beep and turn itself off, and the touch controls may not function while there is liquid on them. Make sure you wipe the touch control area dry before turning the cooktop back on.</i>

Troubleshooting chart

Problem	Possible causes	What to do
The cooktop cannot be turned on.	No power.	Make sure the cooktop is connected to the power supply and that it is switched on at the wall. Check whether there is a power outage in your home or area. If you've checked everything and the problem persists, call your Authorised Service Centre or Customer Care.
The touch controls are unresponsive.	The controls are locked.	Unlock the controls. See section 'Using your induction cooktop' for instructions.
The touch controls are difficult to operate.	There may be a slight film of water over the controls or you may be using the tip of your finger when touching the controls.	Make sure the touch control area is dry and use the ball of your finger when touching the controls.
The glass is being scratched.	Rough-edged cookware.	Use cookware with flat and smooth bases. See 'Choosing the right cookware'.
	Unsuitable, abrasive scourer or cleaning products being used.	See 'Care and cleaning'.
Some or all displays flash  and there is a continuous beep.	Liquid has spilled onto the touch control area.	Switch the power to the cooktop off at the wall and see 'Care and cleaning' for instructions.
	There are objects (eg utensils) on the touch control area.	Remove the objects from the touch control area.
	Several touch controls are registering continuous contact (eg due to someone resting their hand or arm on the touch control area).	Remove the cause of continuous contact.

Troubleshooting chart

Problem	Possible causes	What to do
Some pans make crackling or clicking noises.	This may be caused by the construction of your cookware (layers of different metals vibrating differently).	This is normal for induction cookware and does not indicate a fault.
The cooktop makes a low humming noise when used on a high heat setting (especially PowerBoost).	This is caused by the technology of induction cooking.	This is normal, but the noise should quieten down or disappear completely when you decrease the heat setting.
Fan noise coming from the cooktop.	A cooling fan built into your cooktop has come on to prevent the electronics from overheating. It may continue to run even after you've turned the cooktop off.	This is normal and needs no action. Do not switch the power to the cooktop off at the wall while the fan is running.
Pans do not become hot and \perp appears in the display.	The cooktop cannot detect the pan because it is not suitable for induction cooking.	Use cookware suitable for induction cooking. See section 'Choosing the right cookware'.
	The cooktop cannot detect the pan because it is too small for the cooking zone or not properly centred on it.	Centre the pan and make sure that its base matches the size of the cooking zone.
P flashes in the display when you are trying to set PowerBoost.	PowerBoost is temporarily unavailable because the cooktop needs to protect itself from overheating.	Allow the cooktop to cool down.
The cooktop or a cooking zone has turned itself off unexpectedly, a tone sounds and an error code is displayed (typically E or E_r alternating with one or two digits in the cooking zone displays).	Technical fault.	Please note down the error letters and numbers, switch the power to the cooktop off at the wall, and contact your Authorised Service Centre or Customer Care with the error code information.

Before you call for service or assistance ...

Check the things you can do yourself. Refer to the installation instructions and your user guide and check that:

- 1 your product is correctly installed
- 2 you are familiar with its normal operation.

If after checking these points you still need assistance, please refer to the Service & Warranty book for warranty details and your nearest Authorised Service Centre, or contact us through our local website listed on the back cover.



34 Warranty and service

This cooktop has been designed and constructed in accordance with the following codes and specifications:

In New Zealand and Australia:

AS/NZS 60335-1 General Requirements for Domestic electrical appliances

AS/NZS 60335-2-6 Particular Requirements for Domestic electrical cooking appliances

AS/NZS 1044 Electromagnetic Compatibility Requirements.

In Europe:

Safety requirements of EEC Directive "Low voltage" 2006/95:

- EN 60335-1 General Requirements for Domestic electrical appliances

- EN 60335-2-6 Particular Requirements for Domestic electrical cooking appliances

Safety requirements of EEC Directive "EMC" 89/336:

- EN 55014-1, EN 55014-2, EN 61000-3-2, EN 61000-3-3 Electromagnetic Compatibility Requirements

Requirements of EEC Directive 93/68.



European directive 2002/96/EC on Waste Electrical and Electronic Equipment (WEEE)
(for European Union countries only)

GB This appliance is marked according to the European directive 2002/96/EC on Waste Electrical and Electronic Equipment (WEEE). By ensuring this product is disposed of correctly, you will help prevent potential negative consequences for the environment and human health, which could otherwise be caused by inappropriate waste handling of this product.

The symbol  on the product, or on the documents accompanying the product, indicates that this appliance may not be treated as household waste. Instead it shall be handed over to the applicable collection point for the recycling of electrical and electronic equipment. Disposal must be carried out in accordance with local environmental regulations for waste disposal. For more detailed information about treatment, recovery and recycling of this product, please contact your local city office, your household waste disposal service or the shop where you purchased the product.

Product details

Fisher & Paykel Ltd

Model _____ Serial No. _____

Date of Purchase _____ Purchaser _____

Dealer _____ Suburb _____

Town _____ Country _____







Copyright © Fisher & Paykel 2009. All rights reserved.

The product specifications in this booklet apply to the specific products and models described at the date of issue. Under our policy of continuous product improvement, these specifications may change at any time. You should therefore check with your Dealer to ensure this booklet correctly describes the product currently available.

www.fisherpaykel.co.nz
www.fisherpaykel.com.au
www.fisherpaykel.co.uk
www.fisherpaykel.ie

NZ AU GB IE

Induction cooktop user guide

Published: 02/2009

Part No. 599569 B

F&P Italy Part No. 1103222-β2