

Endeavour

EE72

Double Bowl Topmount Sink With Drainer



All dimensions in mm

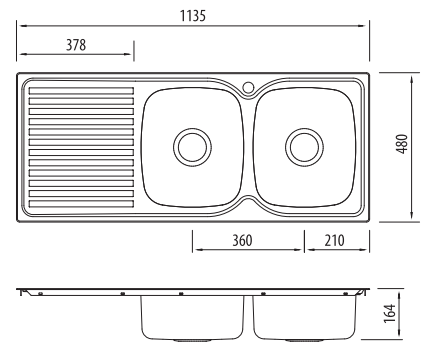

Specifications /

Sink size	1135W x 480H mm
Bowl size	Main Bowl 330W x 385H x 155D / 17L Main Bowl 330W x 385H x 155D / 17L
Construction	2 piece, bowls and drainer seam welded
Material	304 grade, 18/10 polished stainless steel (0.9 mm thick)
Installation	Topmount
Fixings	Adjustable clips supplied, and sealing gasket fitted
Min cabinet size	800 mm
Tap holes	1 tap hole (for no tap hole order product code "EE70")
Waste fittings	2 x 90 mm basket waste included
Overflow	Special order option available
Carton size	1240 x 520 x 190 mm
Weight	8.5 kg
Warranty	Lifetime manufacturer's warranty (refer to oliveri.com.au)
Maintenance and care instructions	All surfaces should be cleaned with mild liquid detergent or soap and water. To maintain the shine on your Oliveri stainless steel sink, we recommended the use of any of the easy to obtain, non-abrasive stainless steel cleaners or metal polishes.

Included accessories /

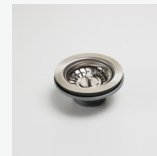

AC14
Basket Waste



AC14
Basket Waste