

KS7490FR

75CM CLASSIC SERIES COLUMN REFRIGERATOR,
494L CAPACITY



 MADE IN ITALY	 75CM SIZE	 494L CAPACITY	 EVENLIFT ADJUSTABLE SHELVES	 DUAL MOVEMENT DOOR HINGE (PIVOT STYLE)
 FROST FREE	 TOUCH CONTROL	 SOFT CLOSE DRAWERS	 SHOPPING MODE	 PROVENT
 OPTI-VIEW LED LIGHTS	 ANTIBACTERIAL STAINLESS STEEL INTERIOR	 ALL FRIDGE	 ANTI VIBRATION	 VACATION MODE
 AVAILABLE WITH LEFT OR RIGHT HINGE	 5 YEAR WARRANTY	 CUSTOM RAL COLOUR FINISHES		

AN EXPRESSION OF QUALITY AND THE PINNACLE OF FOOD PRESERVATION

For those who prefer the consistency of an aesthetic line of elegance and individuality, Fhiaba has developed a series of refrigeration models realising exceptional solutions to conceal the Fridge seamlessly within the interior of the kitchen space, without the compromise of comfort, functionality and design excellence.

Fhiaba is the only company in the world today with technology capable of managing **three independent climate zones**, for unrivalled, high-quality food storage. Fhiaba systems also feature **lateral refrigeration**, thereby allowing for maximum use of the full depth of the inner compartments

Exclusive Fhiaba technology makes it possible to combine the four "key variables" of refrigeration, to create and maintain perfectly balanced climates.

- Accurate temperatures**
Thanks to the numerous built-in sensors, the indicated temperature is always accurate.
- Uniform ProVent Ventilation**
The ProVent system uniformly distributes cold air to all parts of the fridge.
- TriPro Refrigeration**
The triple cooling system ensures each ingredient and dish gets the right micro-climate.
- Humidity control**
Our wine cellars offer three different humidity level settings: low, medium and high.



Pictured: KS7490FR3 with left hand hinge

Additional Extra - available in an optional 12 finishes: 6 metallic or 6 pastel colours

KS7490FR

75CM CLASSIC SERIES COLUMN REFRIGERATOR,
494L CAPACITY



PRODUCT DETAIL

FEATURES

- Meticulously designed & built to withstand prolonged use
- Available with left or right hand hinge options
- Our Classic design seamlessly blends into your kitchen
- Large all refrigerator removes the need for secondary food storage solutions meaning all your groceries can be preserved in one convenient location
- Total No Frost - 100% automatic system which eliminates the need to defrost the fridge, fresh food and freezer compartments. In addition it enables the temperature to be restored quickly after opening thanks to 'speed freezing'.
- Smart-touch TFT controls manages and monitors the entire fridge operation process is simple to use. Fridge, fresh food compartment and drawer temperatures are shown on the digital display
- Accurate temperatures. Thanks to the built-in thermostat, the temperature is always accurate
- Insulated variable speed compressor maintains precision temperature control with minimal vibration
- ProVent ventilation system encourages uniform distribution of cold air in all fridge compartments by laterally circulating air
- Uniform temperature throughout allowing for better food preservation conditions
- Fhiaba Link Device (FLD)
- Deep capacity within a standard depth is achieved by a side-mounted evaporator, which leaves greater interior space
- EvenLift™ means shelves can slide up and down to be adjusted to any height in the fridge compartment
- Air purification system
- Two state of the art compressors and three evaporators ensure continuous operation, energy savings and quiet operation (41 db)

INTERIOR

- Complete anti-bacterial stainless steel interior including shelves and side panels
- Indented shelf perimeter retains & isolates spillages
- Soft-close doors and drawers in all compartments
- 9 LED lights specifically positioned within the refrigerator ensure even light throughout, regardless of what is in the compartment
- Three adjustable glass Rack-and-Pinion Scrolling Glass Shelves and one stationary base shelf.
- Shelves have aluminium profiles
- Three crisper drawers for multi-use preservation solutions. Low temperature with antibacterial stainless steel interiors & rounded corners promoting hygiene and easy cleaning
- Three adjustable door shelves

TEMPERATURE

- One independent climatic zone +2 / + 8°C & low temp zone in the internal drawers

DOOR

- Dual-movement patented hinge, with self-balancing movement ensures stability and resistance
- Pivoting door hinge system enables the appliance to be built-in
- Door open alarm
- Door opening angle: 105°

NOISE

- Noise level - 41db

CAPACITY

- Refrigerator Use-able Storage Capacity:494L

TECHNICAL

- Uniform 2050mm height across all Classic models
- Energy consumption: 168kw/yr
- Net Weight: 210kg
- Power lead length: 2m
- Front and rear adjustable feet up to 25mm height

ACCESSORIES

- KCCIT Joining kit - central (Joining brackets, airflow separation included)
- KITNRG899749 - Transformer for network integration with alternative energy (photovoltaic and geothermal energy, home automation, etc.)

FOLLOW US ON:



/fhiaba_refrigerationau/

fhiaba.com.au

P: 1300 694 583

Eurolinx Showrooms are open Tuesday - Friday 9am - 5pm, Saturday - 10am - 4pm, Sunday and Monday - closed*

***Perth: Tuesday - Friday 10am - 4pm, Saturday, Sunday and Monday - closed**

**NEW SOUTH WALES
(Head Office)**

48-50 Moore Street
Leichhardt

VICTORIA

2r/131 Church St,
Hawthorn

QUEENSLAND

1/42 Cavendish Road
Coorparoo

WESTERN AUSTRALIA

Unit 10/55 Howe Street
Osborne Park

Page 2/4
03052022

DISCLAIMER

Eurolinx PTY LTD, is continually seeking ways to improve the design specifications, aesthetics and production techniques of its products. As a result alterations to our products and designs take place continually. Whilst every effort is made to produce information and literature that is up to date, this brochure should not be regarded as an infallible guide to the current specifications, nor does it constitute an offer for the sale of any particular product. Product dimensions indicated in our literature is indicative only. Actual product only should be used to define dimension cut outs. Distributors, and retailers are not agents of Fhiaba and are not authorised to bind Fhiaba by any express or implied undertaking or representation.

KS7490FR

75CM CLASSIC SERIES COLUMN REFRIGERATOR,
494L CAPACITY

PRODUCT SPECIFICATIONS AND DIMENSIONS

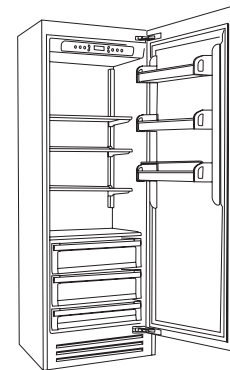
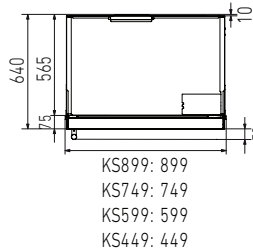
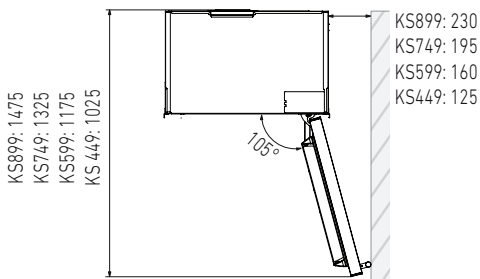
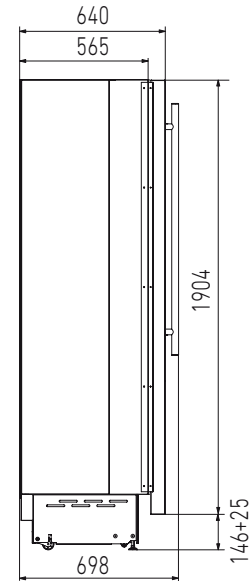
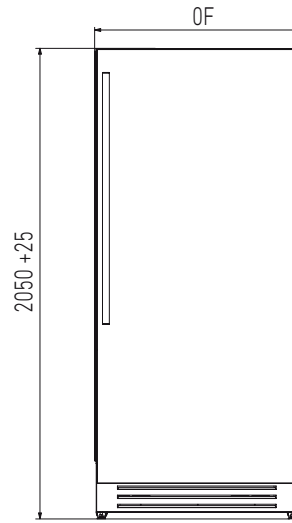
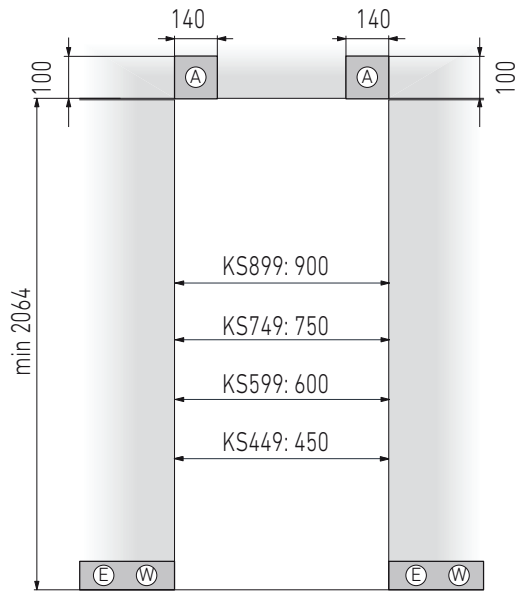

Side by side installation

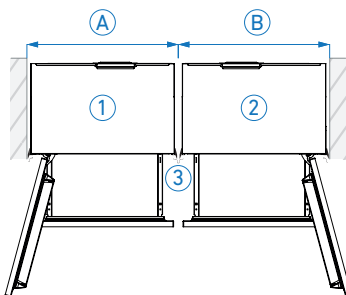

- 1 - Device 1
- 2 - Device 2
- 3 - Joining kit
- A - Niche device 1
- B - Niche device 2

For installation specifications, please consult with Fhiaba. For optimum installation, we recommend using the actual product as the best guide.

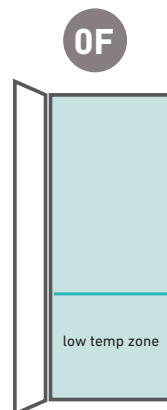

1D | 1M
fridge
D = door
M = separate microclimates

FOLLOW US ON:

/fhiaba_refrigerationau/

P: 1300 694 583

Eurolinx Showrooms are open Tuesday - Friday 9am - 5pm, Saturday - 10am - 4pm, Sunday and Monday - closed*

***Perth: Tuesday - Friday 10am - 4pm, Saturday, Sunday and Monday - closed**

NEW SOUTH WALES
(Head Office)

48-50 Moore Street
Leichhardt

VICTORIA

2r/131 Church St,
Hawthorn

QUEENSLAND

1/42 Cavendish Road
Coorparoo

WESTERN AUSTRALIA

Unit 10/55 Howe Street
Osborne Park

fhiaba.com.au

Page 3/4
03052022

DISCLAIMER

Eurolinx PTY LTD, is continually seeking ways to improve the design specifications, aesthetics and production techniques of its products. As a result alterations to our products and designs take place continually. Whilst every effort is made to produce information and literature that is up to date, this brochure should not be regarded as an infallible guide to the current specifications, nor does it constitute an offer for the sale of any particular product. Product dimensions indicated in our literature is indicative only. Actual product only should be used to define dimension cut outs. Distributors, and retailers are not agents of Fhiaba and are not authorised to bind Fhiaba by any express or implied undertaking or representation.

KS7490FR

75CM CLASSIC SERIES COLUMN REFRIGERATOR,
494L CAPACITY

INSTALLATION INFORMATION



Flush installation

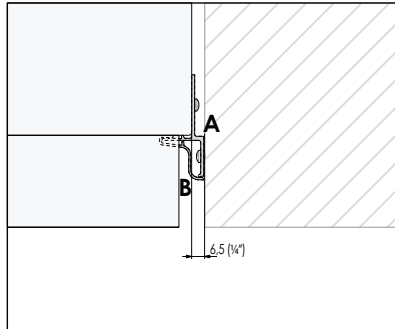

The Lateral Connection Kit (KCLIT/KCLIH/KCLMT/KCLMH) is supplied on all models (except in the unit with stainless steel sides) and consists of a connection element (A) and a aluminium frame (B).

Prominent installation

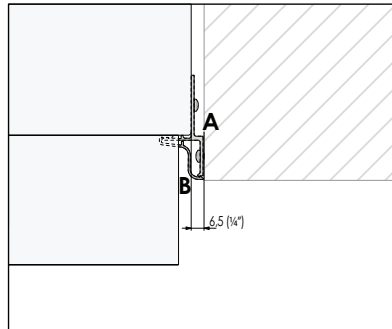
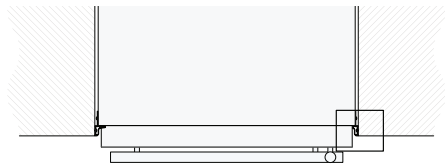

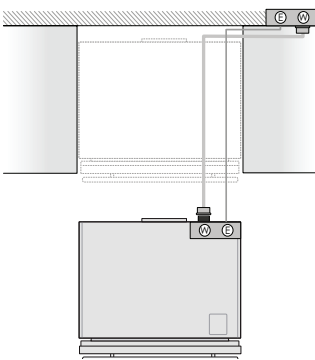

The Lateral Connection Kit (KCLIT/KCLIH/KCLMT/KCLMH) is supplied on all models (except in the unit with stainless steel sides) and consists of a connection element (A) and a aluminium frame (B).

Electrical and Water connection

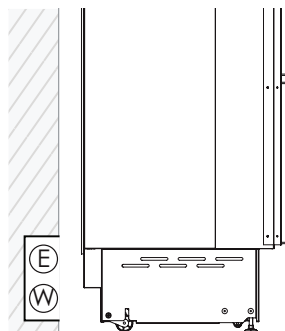

Electrical and Water connection behind the unit



 For installation specifications, please consult with Fhiaba. For optimum installation, we recommend using the actual product as the best guide.

FOLLOW US ON:

 /fhiaba_refrigerationau/

fhiaba.com.au

P: 1300 694 583

Eurolinx Showrooms are open Tuesday - Friday 9am - 5pm, Saturday - 10am - 4pm, Sunday and Monday - closed*

***Perth: Tuesday - Friday 10am - 4pm, Saturday, Sunday and Monday - closed**

NEW SOUTH WALES
(Head Office)

48-50 Moore Street
Leichhardt

VICTORIA

2r/131 Church St,
Hawthorn

QUEENSLAND

1/42 Cavendish Road
Coorparoo

WESTERN AUSTRALIA

Unit 10/55 Howe Street
Osborne Park

Page 4/4
03052022

DISCLAIMER

Eurolinx PTY LTD, is continually seeking ways to improve the design specifications, aesthetics and production techniques of its products. As a result alterations to our products and designs take place continually. Whilst every effort is made to produce information and literature that is up to date, this brochure should not be regarded as an infallible guide to the current specifications, nor does it constitute an offer for the sale of any particular product. Product dimensions indicated in our literature is indicative only. Actual product only should be used to define dimension cut outs. Distributors, and retailers are not agents of Fhiaba and are not authorised to bind Fhiaba by any express or implied undertaking or representation.