

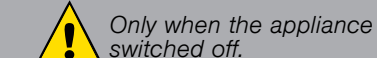

Care and cleaning



Only when the appliance is switched off.

Dryer housing and control panel

- Wipe clean with a soft, damp cloth.
- Do not clean with a water jet.
- Remove detergent and cleaning agent residue immediately.

Exhaust air duct → Exhaust air duct installation instruction.

- Check the exhaust air duct as it may be clogged.
- Clean the exhaust air duct at regular intervals, e.g. every six months.
- Do not bend the exhaust air duct.

- Switch off the dryer and allow it to cool down.
- Disconnect the mains plug.
- Remove the exhaust air duct.
- Clean the exhaust air duct.
- Refit the exhaust air duct.

Moisture sensors

The dryer is equipped with stainless steel moisture sensors. Moisture sensors measure the moisture level of the laundry. After sustained, repeated operation, a fine layer of limescale may form on the moisture sensors.

- Open the door.
- Clean the moisture sensors with a damp sponge which has a rough surface.

Do not use steel wool or abrasive agents!



Installation

- Scope of delivery: dryer, operating and installation instructions, basket for woollens (depending on the model).
- Check the dryer for transport damage.
- The dryer is very heavy. Do not attempt to lift it on your own.
- Be careful to avoid sharp edges.
- Do not lift the dryer by protruding parts (e.g. the door) - risk of breakage.
- Do not set up in a room that is susceptible to frost. Freezing water may cause damage.
- If in doubt, have the appliance connected by a specialist.

1. Setting up the dryer

- The mains plug must always be accessible.
- Ensure that the appliance is placed on a clean, level and firm surface.
- Install the exhaust air duct → Exhaust air duct installation instruction.
- Keep the area around the dryer clean.
- Level the dryer using the threaded feet and a spirit level.
- Never remove the threaded feet!

Do not install the dryer behind a door or sliding door which could prevent or obstruct the dryer door from opening. This will prevent children from locking themselves in and risking their lives.

Take all accessory parts out of the drum. The drum must be empty.

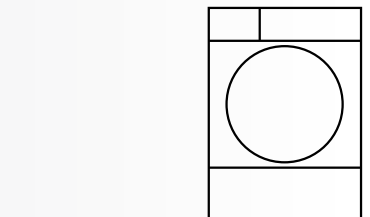

Clean and level.

2. For mains connection, see Safety instructions → page 13.

- Connect to an AC earthed socket. If in doubt have the socket checked by a specialist.
- The mains voltage and the voltage shown on the rating plate (→ page 10) must be the same.
- The connected load and necessary fuse protection are specified on the rating plate.

Optional accessories

- WTZ 1130 Exhaust air duct set**
The exhaust air is extracted via a hose.
- WTZ 11311 Washer-dryer stack connection set**
The dryer can be placed on top of a suitable washing machine with the same width and depth to save space. The dryer **must be** fastened to the washing machine using this connection set. If the worktop of the washing machine is less than 544 mm deep, please consult the after-sales service or your specialist retailer.
- WMZ 20500 Platform**
For easier loading and unloading. The basket contained in the drawer can be used to carry the laundry.

Technical data

Dimensions (DxWxH)	60 x 60 x 85 cm (height adjustable)
Weight	approx. 36 kg
Max. capacity	7 kg
Connection voltage	220-240 V
Connected load	2200 W
Fuse protection	10 A
Ambient temperature	5 - 35°C
Product number	Inside of door
Production number	Inside of door

The rating plate can be found on the back of the dryer.

Consumption rates

Fabrics/programmes	Residual moisture in the fabrics after spinning		Drying time**	Energy consumption**
Cottons 7 kg	1400 rpm	(50%)	107 min	3.16 kWh
	1000 rpm	(60%)	128 min	3.95 kWh
	800 rpm	(70%)	149 min	4.60 kWh
Iron Dry*	1400 rpm	(50%)	83 min	1.96 kWh
	1000 rpm	(60%)	99 min	2.92 kWh
	800 rpm	(70%)	116 min	3.63 kWh
Synthetics 3.5 kg	800 rpm	(40%)	47 min	1.32 kWh
	600 rpm	(50%)	59 min	1.72 kWh
	800 rpm	(40%)	47 min	1.32 kWh

* Programme setting for testing in accordance with applicable standard DIN EN61121.
** The values may differ from those specified, depending on the type of fabric, composition of laundry to be dried, residual moisture in the fabric and the amount of laundry being loaded.

After-sales service

If you cannot rectify the fault yourself (e.g. switching off/on) → *What to do if...*, page 11/12, please contact our after-sales service. We will always find an appropriate solution and avoid unnecessary visits by engineers.

The contact details of your local **after-sales service** can be found in the enclosed after-sales service directory.
– **GB** 0344 892 8979 (Calls charged at local or mobile rate.)
– **IE** 01450 2655 (0.03 € per minute at peak. Off peak 0.0088 € per minute.)

Please provide the after-sales service the product number (E no.) and the production number (FD) of the appliance.

E-Nr. _____ **FD** _____
Product number Production number

Trust the expertise of the manufacturer. Contact us for assistance. In this way, you can rest assured that the repair will be carried out by trained service technicians using original spare parts.

What to do if ...

- Turn the programme selector to **Off** and remove the mains plug from the socket.
- The **Start/Pause** indicator light does not light up. Mains plug plugged in? Programme selected? Check the socket fuse.
- The display panel light and indicator lights (depending on model) go out and the **Start/Pause** indicator light flashes. Energy-saving mode is activated → see the separate *Energy-saving mode* instructions.
- The display panel switches off. The appliance goes into the sleep mode after activating **Finished in** option → page 5.
- (Fluff filter/Exhaust air duct)** indicator light flashes. Clean the fluff filter → page 4. Press the **Start/Pause** button to reset the displayed indication and then press the **Start/Pause** button again to restart the appliance if necessary. Exhaust air duct blocked or bent? Clean the exhaust air duct → page 8. If necessary, clean the insect screen on the exhaust air pipe.
- Dryer does not start. **Start/Pause** button selected? Door closed? Programme set?
- Programme terminates shortly after starting. Ambient temperature greater than 5°C? Is the appliance loaded with the laundry? Load too small for selected programme?/Use timed programme → page 6/7. Loaded laundry dry?
- Water is leaking out. Make sure the dryer is level.

What to do if ...

- The door opens by itself. Push the door closed until you hear it engage.
- Drying result is not satisfactory (laundry feels too damp). Warm laundry feels damper than it really is. The selected programme does not suit the load. Use another drying programme or, in addition, select the timed programme → page 7. Dryer installed too closely to other objects? Provide adequate air circulation. Use **Fine adjust** for the dryness levels → page 5. Fine layer of limescale on the humidity sensors → Clean the moisture sensors → page 8. Programme termination, e.g. mains power supply failure, door open or maximum drying time reached? Clean the fluff filter under running water → page 4. Insufficient supply of air → Ensure that air can circulate. Ambient temperature greater than 35°C → Ventilate the room.
- The humidity in the room increases. Make sure the room is sufficiently ventilated. Exhaust air duct installed/the exhaust air routes directly into the open air? → *Installation instructions for exhaust air duct*, page 1.
- One or more indicator lights are flashing. Clean the fluff filter → page 4/11. Check the installation conditions → page 9. Exhaust air duct blocked or bent? Clean the exhaust air duct → page 8. Switch off, allow to cool, switch back on, and restart the programme.
- Power failure. Remove the laundry from the dryer immediately and spread out. This allows the heat to dissipate. Be careful as the door, the drum and the laundry may be hot.
- Condensation in the exhaust air duct. Exhaust air duct too long? Check the maximum exhaust air duct length. Further information → *Installation instructions for exhaust air duct*.

Safety instructions

- Emergency ONLY use the dryer...** – Pull the mains plug out of the socket immediately or disconnect the fuse. – in rooms inside the house. – for drying fabrics.
- The dryer must NEVER...** – be used for purposes other than those described above. – be modified in terms of its technology or attributes.
- Dangers** – The dryer must not be used by children or persons who have not been instructed in its use. – Do not leave children unsupervised near the dryer. – Keep pets away from the dryer. – Remove all objects from the pockets of garments. Pay particular attention to cigarette lighters → **Risk of explosion** – Do not lean or sit on the door → **Risk of tipping**. – Open the door with care. Hot steam may escape.
- Installation** – Fasten down loose leads → **Risk of tripping** – Do not operate the dryer where there is a risk of frost. – The safety information in the separate installation instructions for the exhaust air duct must be observed without fail.
- Mains connection** – Connect the dryer to an AC earthed socket according to specifications, as otherwise it cannot be guaranteed that the appliance is completely safe. – The cable cross-section must be sufficient. – Only use earth-leakage circuit breakers with the following symbol: – The mains plug and socket must be compatible. – Do not use multiple plugs/couplings and/or extension cables. – Do not touch or hold the mains plug with wet hands → **Risk of electric shock**. – Never pull the mains plug out of the socket by its cable. – Do not damage the mains lead → **Risk of electric shock**.
- Operation** – Only load the drum with items of laundry. Check what has been loaded before switching the dryer on. – Do not use the dryer if the laundry has been in contact with solvents, oil, wax, grease or paint (e.g. hair spray, nail polish remover, stain remover, cleaning solvent, etc.) → **Risk of fire/explosion**. – The tumble dryer is not to be used if industrial chemicals have been used for cleaning. – Dust risk (e.g. coal dust or flour): do not use the dryer → **Risk of explosion**. – Do not turn off the dryer until the drying process ends, unless the laundry will be removed quickly and spread out, so that the heat can dissipate. – Do not put laundry containing foamed material/rubber in the dryer → elastic material may be destroyed and the dryer may be damaged due to possible deformation of the foamed material. – Final part of a tumble dryer cycle occurs without heat (cool down cycle), to ensure that the items are left at a temperature that ensures that the items will not be damaged. – Switch off the dryer once the programme has ended.
- Defect** – Do not use the dryer if it is defective or if you suspect that it is. Repairs must only be carried out by the after-sales service. – Do not use the dryer with a faulty mains cable. In order to avoid danger, have the mains lead replaced only by our after-sales service.
- Spare parts Disposal** – For safety reasons, you must only use genuine spare parts and accessories. – Dryer: Disconnect the mains plug, **then** cut the mains cable off the appliance. Dispose of the appliance at a municipal waste disposal site. – Packaging: Do not allow children access to items of packaging → **Risk of suffocation**. – All materials are environmentally friendly and reusable. Dispose of them in an environmentally responsible manner.



Register your new Bosch now:
www.bosch-home.com/welcome

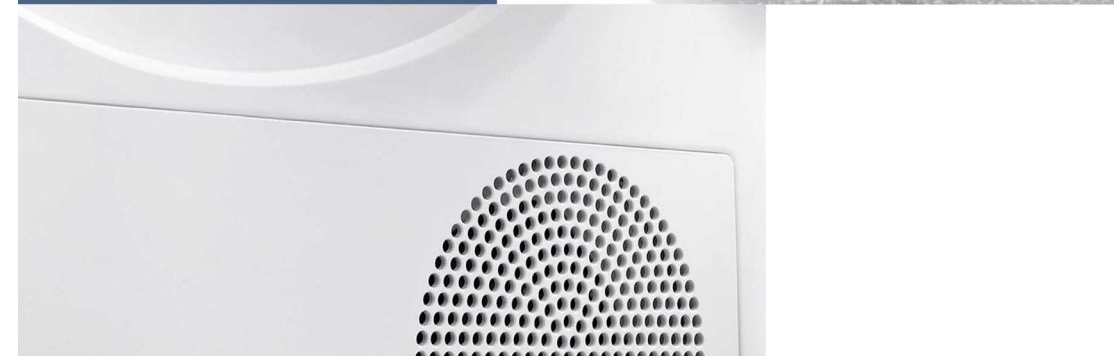

Dryer
WTA74200AU



en Instruction manual

Your new dryer

Congratulations - You have chosen to buy a modern, high-quality Bosch domestic appliance.

A distinctive feature of your dryer is its low energy consumption.

Every dryer which leaves our factory is carefully checked to ensure that it functions correctly and is in perfect condition.

Should you have any questions, our after-sales service will be pleased to help.

Disposal in an environmentally-responsible manner



This appliance is labelled in accordance with European Directive 2012/19/EU concerning used electrical and electronic appliances (waste electrical and electronic equipment - WEEE). The guideline determines the framework for the return and recycling of used appliances as applicable throughout the EU.

For further information about our products, accessories, spare parts and services, please visit: www.bosch-home.com

Intended use

- exclusively for domestic use,
- only for drying fabrics which have been washed using water.



Keep children younger than 3 years old away from the dryer.
Do not let children make the cleaning and maintenance work on the dryer without supervision.
Do not leave children unsupervised near the dryer.
Keep pets away from the dryer.
The dryer may be operated by children from 8 years of age, by persons who have limited physical, sensory or mental abilities and by persons who have inadequate experience or knowledge, provided they are supervised or have been instructed by a responsible person.

Preparation

Installation → page 9
and Exhaust air duct installation instructions



Never start
Inform you

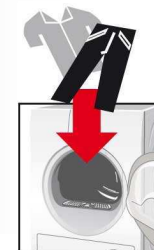

Programme sel
the programme
on/off. Can be



Observe the safety instructions on page 13.



Read these instructions, the **Installation Instructions** and the separate **Energy-saving mode** instructions before operating the dryer.

Contents

Page

■ Preparation	2
■ Control panel	2
■ Drying	3/4
■ Display panel and settings	5
■ Notes on laundry	6
■ Overview of programmes	7
■ Care and cleaning	8
■ Installation	9
■ Optional accessories	10
■ Technical data	10
■ Consumption rates	10
■ After-sales service	11
■ What to do if ...	11/12
■ Safety instructions	13

Programmes / Fabrics

Detailed overview of the programmes and fabrics
→ Programme overview, page 7.
Observe the care instructions on the care label.

Cottons	Hard-wearing fabrics.
Synthetics	Fabrics made from synthetic or blended fabrics.
Dryness levels to select with the Cottons and Synthetics programmes:	
Extra Dry/Very Dry	Thick and multi-layered fabrics.
Cupboard Dry	Single-layered laundry.
Iron Dry	Laundry suitable for ironing after drying.
Sportswear	Functional clothing made of microfibre.
Towels	Terry-towelling laundry e.g. towels and bathrobes.
Mixed Load	A mixed load of fabrics made of cotton and synthetic fabrics.
Timed program warm	} All types of fabric except for wool and silk.
Timed program cold	
Shirts/Blouses	Cotton or linen fabrics that are still damp and easy-care fabrics.
Super 40'	Synthetics, cotton or blended fabrics.
Wool finish	Woollen fabrics that are suitable for use in washers.
Delicate/Silk	Lingerie made of synthetic fibres, cotton or blended fabric.

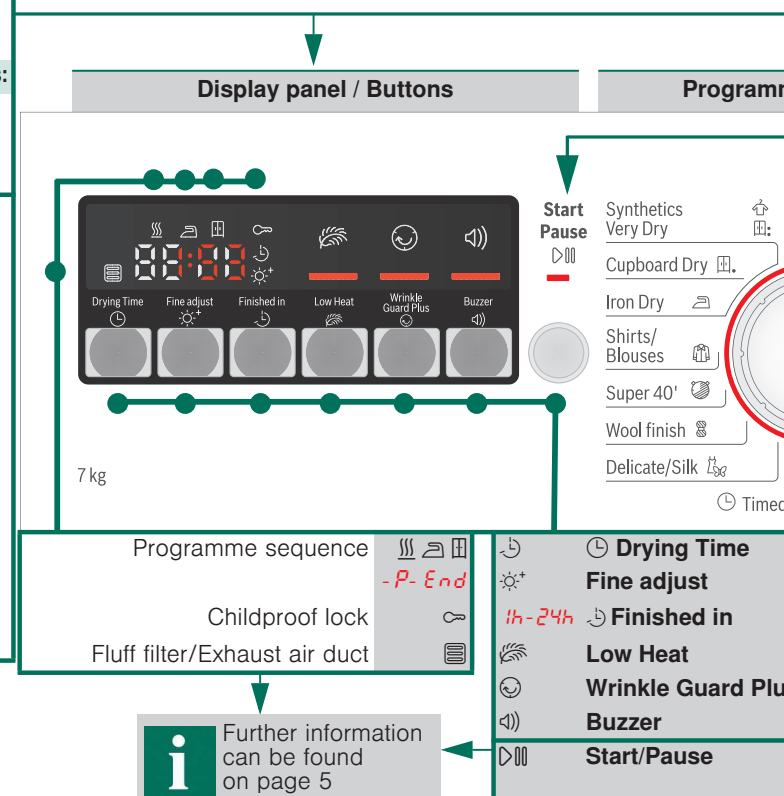

struction.

t the dryer if it is damaged!
r after-sales service!

Before using the dryer for the first time
run the drying cycle without any laundry → page 6.

Inspect the dryer



Make sure your hands are dry.
Only grasp the plug by the plug
body.

Connect the mains plug



Sort the laundry

Remove all items from pockets,
especially cigarette lighters.
The drum must be empty prior to loading.

ector for setting
and switching the appliance
turned in both directions.

Set and adjust the programme individually

me selector / Off



Close the door

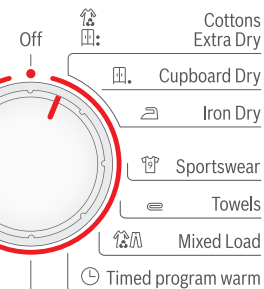

Select Start/Pause

program cold

Setting the drying time available only for timed programmes.
Fine adjustment of dryness level.
Setting the programme end.
Low-heat drying – reduced temperature.
Extends the anti-crease function.
Buzzer on/off.

Starts, pauses and continues the programme;
activates or deactivates (Childproof lock).

Drying



1

2

3



6

Clean the fluff filter

i Do not operate the dryer without a fluff filter
or with a defective fluff filter. A clean fluff filter
minimises energy consumption.

Clean the fluff filter **after** each drying cycle:

1. Open the door. Remove any fluff from the door/around the door and pull out the fluff filter.
2. Remove the fluff from the shaft of the fluff filter.
3. Remove the fluff (sweep your hand over the fluff filter). If the fluff filter is very dirty or blocked, rinse with warm water and dry thoroughly.
4. Insert the fluff filter so that you hear it engage.

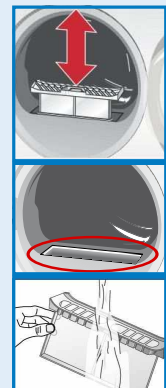

5

Remove the laundry and switch off the dryer

4

End of the programme...

Interrupt the programme

1. Open the door or press the Start/Pause button; the drying cycle is interrupted.
2. Add or remove laundry and close the door.
3. If required, select a new programme and additional functions. Select the Start/Pause button. The remaining time is updated after a few minutes.



The drum and door may be hot!

Drying

Display panel and settings

Display panel (status indicators)



(Fluff filter/Exhaust air duct) Clean the fluff filter → page 4/11 or check the exhaust air duct → page 8.

(Programme sequence)

These indicators show the programme progress in the next steps of the drying cycle:

- Drying;
- Iron Dry;
- Cupboard Dry;
- **P** - Programme pause → if required;
- End** Programme end.



(Childproof lock) You can lock the dryer to prevent the functions you have set from being changed inadvertently. To activate/deactivate **(Childproof lock)** start the programme and then press and hold the **Start/Pause** button for 5 seconds until a long acoustic signal is heard. The option activated/deactivated → **(Childproof lock)** indicator light on/off.

(Remaining time)

When a programme is selected, the anticipated drying time (remaining time) for the recommended load is displayed. While drying, the moisture sensors detect the actual load and correct the programme length. This is shown by jumps in the remaining time in the display panel.

Settings (indicators lights and buttons)



Selected option activated/deactivated → indicator light on/off. See the separate **Energy-saving mode** instructions.



Drying time Drying time, available only for timed programmes, can be selected from min. 0:20 h to max. 3:00 h, in 10-minute steps.



Fine adjust The dryness levels can be increased in three levels. The laundry is made drier. Default = 0. Selectable values: 0, 1, 2, 3. After setting the level of the fine adjustment for a programme, it is also retained for other programmes, until **Fine adjust** is changed again.

Finished in

The time when the programme has to end can be set by selecting the **Finished in** time. The **Finished in** time can be selected in one-hour steps, up to a maximum of 24 hours. Select the **Finished in** button repeatedly until the required number of hours is displayed. Then press the **Start/Pause** button to activate the **Finished in** option. The programme ends after the selected number of hours. Several minutes after activating **Finished in** option the display switches off to save energy. To switch it on select any button, close/open the door or turn the programme selector.



Low Heat Reduced temperature for delicate fabrics, e.g. polyacrylic, polyamide or elastane, with a longer drying time.



Wrinkle Guard Plus After the programme finishes, the drum moves at regular intervals to prevent creases. Laundry remains loose and fluffy. The standard setting for each programme is 60 min. Automatic anti-crease function can be extended by up to 60 min.



Buzzer For switching the buzzer on and off. **Buzzer** indicates program end if it is activated. Other sounds are not influenced by this option.

Notes on laundry ...



Labelling of fabrics

Follow the manufacturer's care instructions.

- Suitable for tumble drying.
- Dry at normal temperature.
- Dry at low temperature → in addition, select **Low Heat**.
- Do not tumble dry.

Do not tumble dry the following fabrics:

- Non-breathable fabrics (e.g. rubber-coated).
- Delicate materials (silk, curtains made from synthetic material) → these may crease.
- Oil-stained laundry.



Before drying for the first time

- Do not put any laundry in the machine. Turn the programme selector to **Timed program** (→ page 7) and select **Start/Pause**. At the end of the programme, turn the programme selector to **Off**.



Drying tips

- To ensure a consistent drying result, sort the laundry by fabric type and drying programme.
- Always dry very small fabrics (e.g. baby socks) together with large items of laundry (e.g. towels).
- Close zips, hooks and eyelets, and button up covers. Tie cloth belts, apron strings, etc. together or use a laundry bag.
- Do not over-dry easy-care laundry → risk of creasing. Allow laundry to finish drying in the air.
- Do not dry woollens in the dryer. They may, however, be refreshed in the dryer → page 7, **Wool finish** programme (depending on model).
- Do not iron laundry immediately after drying; fold items up and leave for a while → residual moisture will then be distributed evenly.
- Knitted fabrics (e.g. T-shirts, jerseys) often shrink slightly the first time they are tumble-dried. → Do not use the **Extra Dry** programme.
- Starched laundry is not always suitable for dryers → starch leaves behind a coating that reduces the drying effect.
- When washing laundry that is to be tumble dried afterwards, use the correct amount of fabric softener as specified in the manufacturer's instructions.
- For pre-dried, multi-layered fabrics or small, individual items of laundry, use the timed programme. Also suitable for subsequent drying.

Environmental protection / Energy-saving tips

- Before drying, spin the laundry in the washing machine → higher spin speeds minimise the drying time and reduce energy consumption.
- Use the maximum recommended capacity, but do not exceed it → Programme overview, page 7.
- Make sure the room is well ventilated during drying.
- Clean the fluff filter after every drying cycle → Clean the fluff filter, page 4/11.

Programme overview

see also page 6.

Sort the laundry according to type of textile and fabric. Fabrics must be suitable for tumble drying.

After drying, laundry is to be ...



lightly ironed



PROGRAMMES

TEXTILE TYPE AND INFORMATION

Cottons	max. 7 kg	Hard-wearing fabrics, boil-proof fabrics made of cotton or linen.
Synthetics	max. 3.5 kg	Non-iron laundry made of synthetic fibres and mixed fabric, easy-care cotton.
Iron Dry		The condition of the laundry means it is suitable for ironing (iron clothes in order to avoid creases).
Cupboard Dry		Single-layered laundry.
Extra Dry/Very Dry		Laundry with thick, multi-layered parts.
Sportswear	max. 1.5 kg	Fabrics with membrane coating, water-repellent fabrics, functional clothing, fleece fabrics (dry jackets/trousers with removable internal lining separately).
Towels	max. 6 kg	Terry-towelling laundry e.g. towels and bathrobes.
Mixed Load	max. 3 kg	Mixed items of laundry made of cotton and synthetics (Mix).
Timed program warm	max. 3 kg	Pre-dried, multi-layered, sensitive fabrics made of acrylic fibres, or separate small items of laundry. Also for subsequent drying.
Timed program cold	max. 3 kg	All types of fabrics. For freshening up or airing of items of laundry that have been worn for a short period of time.
Shirts/Blouses	max. 3 kg	Cotton or linen fabrics that are still damp and easy-care fabrics. Creasing in fabrics is reduced. Fabrics are not dried completely. Hang up fabrics!
Super 40'	max. 2 kg	Laundry made of synthetic fibres, cotton or blended fabrics (for example) that needs to be dried quickly. The values may differ from the those specified depending on the type of fabric, mixture of laundry to be dried, residual moisture in the fabric and loading capacity.
Wool finish	max. 3 kg	Woollen fabrics suitable for washers. Fabrics become fluffier but not dry.
Delicate/Silk	max. 1 kg	Remove fabrics once the programme has ended and allow to dry. Lingerie made of synthetic fibres, cotton or blended fabric.

*Dryness levels can be selected individually → : Extra Dry/Very Dry, : Cupboard Dry and : Iron Dry (depending on the model). Degree of dryness can be finely adjusted; multi-layered textiles require a longer drying time than single-layered items of clothing. Recommendation: Dry separately.

9409 / 9000924955



Robert Bosch Hausgeräte GmbH
Carl-Wery-Str. 34
81739 München/Deutschland

WTA74200AU

Care and cleaning



Only when the appliance is switched off.

Dryer housing and control panel

- Wipe clean with a soft, damp cloth.
- Do not clean with a water jet.
- Remove detergent and cleaning agent residue immediately.

Exhaust air duct → Exhaust air duct installation instruction.

Check the exhaust air duct as it may be clogged.

Clean the exhaust air duct at regular intervals, e.g. every six months.
Do not bend the exhaust air duct.

1. Switch off the dryer and allow it to cool down.
2. Disconnect the mains plug.
3. Remove the exhaust air duct.
4. Clean the exhaust air duct.
5. Refit the exhaust air duct.

Moisture sensors

The dryer is equipped with stainless steel moisture sensors. Moisture sensors measure the moisture level of the laundry. After sustained, repeated operation, a fine layer of limescale may form on the moisture sensors.

1. Open the door.
2. Clean the moisture sensors with a damp sponge which has a rough surface.



Do not use steel wool or abrasive agents!

Installation

- Scope of delivery: dryer, operating and installation instructions, basket for woollens (depending on the model).
- Check the dryer for transport damage.
- The dryer is very heavy. Do not attempt to lift it on your own.
- Be careful to avoid sharp edges.
- Do not lift the dryer by protruding parts (e.g. the door) - risk of breakage.
- Do not set up in a room that is susceptible to frost. Freezing water may cause damage.
- If in doubt, have the appliance connected by a specialist.

1. Setting up the dryer

- The mains plug must always be accessible.
- Ensure that the appliance is placed on a clean, level and firm surface.
- Install the exhaust air duct → Exhaust air duct installation instruction.
- Keep the area around the dryer clean.
- Level the dryer using the threaded feet and a spirit level. Never remove the threaded feet!



Take all accessory parts out of the drum.
The drum must be empty.



Do not install the dryer behind a door or sliding door which could prevent or obstruct the dryer door from opening. This will prevent children from locking themselves in and risking their lives.

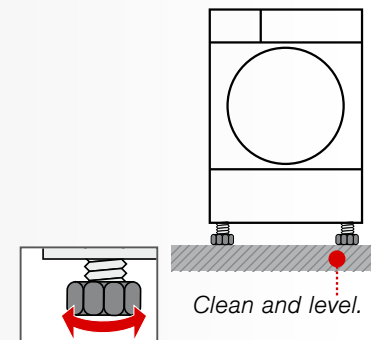

2. For mains connection, see Safety instructions → page 13.

- Connect to an AC earthed socket. If in doubt have the socket checked by a specialist.
- The mains voltage and the voltage shown on the rating plate (→ page 10) must be the same.
- The connected load and necessary fuse protection are specified on the rating plate.

Optional accessories (order from the after-sales service using the order number, according to model)

WTZ 1130 **Exhaust air duct set**
The exhaust air is extracted via a hose.

WTZ 11311 **Washer-dryer stack connection set**
The dryer can be placed on top of a suitable washing machine with the same width and depth to save space. The dryer **must be** fastened to the washing machine using this connection set. If the worktop of the washing machine is less than 544 mm deep, please consult the after-sales service or your specialist retailer.

WMZ 20500 **Platform**
For easier loading and unloading. The basket contained in the drawer can be used to carry the laundry.

Technical data

Dimensions (DxWxH)	60 x 60 x 85 cm (height adjustable)
Weight	approx. 36 kg
Max. capacity	7 kg
Connection voltage	220-240 V
Connected load	2200 W
Fuse protection	10 A
Ambient temperature	5 - 35°C
Product number	Inside of door
Production number	Inside of door

The rating plate can be found on the back of the dryer.

Consumption rates

Fabrics/programmes	Residual moisture in the fabrics after spinning		Drying time**	Energy consumption**	
Cottons 7 kg					
Cupboard Dry*	1400 rpm	(50%)	107 min	3.16 kWh	
	1000 rpm	(60%)	128 min	3.95 kWh	
	800 rpm	(70%)	149 min	4.60 kWh	
Iron Dry*	1400 rpm	(50%)	83 min	1.96 kWh	
	1000 rpm	(60%)	99 min	2.92 kWh	
	800 rpm	(70%)	116 min	3.63 kWh	
Synthetics 3.5 kg					
	Cupboard Dry*	800 rpm	(40%)	47 min	1.32 kWh
		600 rpm	(50%)	59 min	1.72 kWh

* Programme setting for testing in accordance with applicable standard DIN EN61121.

** The values may differ from those specified, depending on the type of fabric, composition of laundry to be dried, residual moisture in the fabric and the amount of laundry being loaded.

After-sales service

If you cannot rectify the fault yourself (e.g. switching off/on) → *What to do if...*, page 11/12, please contact our after-sales service. We will always find an appropriate solution and avoid unnecessary visits by engineers.

The contact details of your local **after-sales service** can be found in the enclosed after-sales service directory.

- **GB** 0344 892 8979 (Calls charged at local or mobile rate.)
- **IE** 01450 2655 (0.03 € per minute at peak. Off peak 0.0088 € per minute.)

Please provide the after-sales service the product number (E no.) and the production number (FD) of the appliance.

E-Nr. _____ FD _____

Product number Production number

*You can find this information:
inside the door* / in the opened service flap*
and on the rear of the appliance.
depending on the model

Trust the expertise of the manufacturer. Contact us for assistance. In this way, you can rest assured that the repair will be carried out by trained service technicians using original spare parts.

What to do if ...



Turn the programme selector to **Off** and remove the mains plug from the socket.

- The **Start/Pause** indicator light does not light up. Mains plug plugged in? Programme selected? Check the socket fuse.
- The display panel light and indicator lights (*depending on model*) go out and the **Start/Pause** indicator light flashes. Energy-saving mode is activated → see the separate *Energy-saving mode* instructions.
- The display panel switches off. The appliance goes into the sleep mode after activating **Finished in** option → page 5.
- (**Fluff filter/Exhaust air duct**) indicator light flashes. Clean the fluff filter → page 4. Press the **Start/Pause** button to reset the displayed indication and then press the **Start/Pause** button again to restart the appliance if necessary. Exhaust air duct blocked or bent? Clean the exhaust air duct → page 8. If necessary, clean the insect screen on the exhaust air pipe.
- Dryer does not start. **Start/Pause** button selected? Door closed? Programme set?
- Programme terminates shortly after starting. Ambient temperature greater than 5°C? Is the appliance loaded with the laundry? Load too small for selected programme?/Use timed programme → page 6/7. Loaded laundry dry?
- Water is leaking out. Make sure the dryer is level.

What to do if ...

● The door opens by itself.	Push the door closed until you hear it engage.
● Drying result is not satisfactory (laundry feels too damp).	Warm laundry feels damper than it really is. The selected programme does not suit the load. Use another drying programme or, in addition, select the timed programme → <i>page 7</i> . Dryer installed too closely to other objects? Provide adequate air circulation. Use ☀* Fine adjust for the dryness levels → <i>page 5</i> . Fine layer of limescale on the humidity sensors → Clean the moisture sensors → <i>page 8</i> . Programme termination, e.g. mains power supply failure, door open or maximum drying time reached?
● Drying time too long.	Clean the fluff filter under running water → <i>page 4</i> . Insufficient supply of air → Ensure that air can circulate. Ambient temperature greater than 35°C → Ventilate the room.
● The humidity in the room increases.	Make sure the room is sufficiently ventilated. Exhaust air duct installed/the exhaust air routes directly into the open air? → <i>Installation instructions for exhaust air duct, page 1</i> .
● One or more indicator lights are flashing.	Clean the fluff filter → <i>page 4/11</i> . Check the installation conditions → <i>page 9</i> . Exhaust air duct blocked or bent? Clean the exhaust air duct → <i>page 8</i> . Switch off, allow to cool, switch back on, and restart the programme.
● Power failure.	Remove the laundry from the dryer immediately and spread out. This allows the heat to dissipate. Be careful as the door, the drum and the laundry may be hot.
● Condensation in the exhaust air duct.	Exhaust air duct too long? Check the maximum exhaust air duct length. Further information → <i>Installation instructions for exhaust air duct</i> .

Safety instructions



Emergency	– Pull the mains plug out of the socket immediately or disconnect the fuse.
ONLY use the dryer...	– in rooms inside the house. – for drying fabrics.
The dryer must NEVER...	– be used for purposes other than those described above. – be modified in terms of its technology or attributes.
Dangers	– The dryer must not be used by children or persons who have not been instructed in its use. – Do not leave children unsupervised near the dryer. – Keep pets away from the dryer. – Remove all objects from the pockets of garments. – Pay particular attention to cigarette lighters → Risk of explosion – Do not lean or sit on the door → Risk of tipping . – Open the door with care. Hot steam may escape.
Installation	– Fasten down loose leads → Risk of tripping – Do not operate the dryer where there is a risk of frost. – The safety information in the separate installation instructions for the exhaust air duct must be observed without fail.
Mains connection	– Connect the dryer to an AC earthed socket according to specifications, as otherwise it cannot be guaranteed that the appliance is completely safe. – The cable cross-section must be sufficient. – Only use earth-leakage circuit breakers with the following symbol:  – The mains plug and socket must be compatible. – Do not use multiple plugs/couplings and/or extension cables. – Do not touch or hold the mains plug with wet hands → Risk of electric shock . – Never pull the mains plug out of the socket by its cable. – Do not damage the mains lead → Risk of electric shock .
Operation	– Only load the drum with items of laundry. – Check what has been loaded before switching the dryer on. – Do not use the dryer if the laundry has been in contact with solvents, oil, wax, grease or paint (e.g. hair spray, nail polish remover, stain remover, cleaning solvent, etc.) → Risk of fire/explosion . – The tumble dryer is not to be used if industrial chemicals have been used for cleaning. – Dust risk (e.g. coal dust or flour): do not use the dryer → Risk of explosion . – Do not turn off the dryer until the drying process ends, unless the laundry will be removed quickly and spread out, so that the heat can dissipate. – Do not put laundry containing foamed material/rubber in the dryer → elastic material may be destroyed and the dryer may be damaged due to possible deformation of the foamed material. – Final part of a tumble dryer cycle occurs without heat (cool down cycle), to ensure that the items are left at a temperature that ensures that the items will not be damaged. – Switch off the dryer once the programme has ended.
Defect	– Do not use the dryer if it is defective or if you suspect that it is. – Repairs must only be carried out by the after-sales service. – Do not use the dryer with a faulty mains cable. In order to avoid danger, have the mains lead replaced only by our after-sales service.
Spare parts	– For safety reasons, you must only use genuine spare parts and accessories.
Disposal	– Dryer: Disconnect the mains plug, then cut the mains cable off the appliance. Dispose of the appliance at a municipal waste disposal site. – Packaging: Do not allow children access to items of packaging → Risk of suffocation . – All materials are environmentally friendly and reusable. – Dispose of them in an environmentally responsible manner.



Register your new Bosch now:
www.bosch-home.com/welcome



Dryer
WTA74200AU



en Instruction manual