

Hisense

life reimagined

USER'S OPERATION MANUAL

Before operating this unit, please read this manual thoroughly, and retain for future reference

HR6TFF534SD
HR6TFF527SD
HR6TFF437SD

English

Contents

Brief introduction.....	2	Using your appliance.....	8
Important safety instructions.....	2	Helpful hints and tips.....	10
Installing your new appliance.....	4	Cleaning and care.....	11
Description of the appliance.....	6	Troubleshooting.....	12
Display controls.....	7	Disposal of the appliance.....	13

Brief introduction

Thank you for your choosing our products. We are sure you will find your new appliance a pleasure to use. Before you use the appliance, we recommend that you read through these instructions carefully, which provides details about its usage and functions.

- Please ensure that all people using this appliance are familiar with its operations and safety features. It is important that you install the appliance correctly and pay attention to the safety instructions carefully.

- We recommend that you keep this user's manual with the appliance for future reference and retain it to any future users

- This appliance is intended to be used in household and similar applications such as:

- Staff kitchen- areas in shops, offices and other working environments;

- Farmhouses by clients in hotels, motels and other residential types of environment;

- Bed and breakfast type of environments.

- Catering and similar non-retail applications.

- If you feel that the appliance is not operating correctly, please check the Troubleshooting page for assistance. If still in doubt contact the customer service help line for assistance or to arrange a call out by an authorized service engineer.

Important safety instructions

General safety and daily use



It is important to use your appliance safely. We

recommend that you follow the guidelines below.

- Store any food in accordance with the storage instructions from the manufacturer.

- Don't try to repair the appliance yourself. It is dangerous to alter the specifications or modify this product in any way. Any damage to the cord may

cause short circuit, fire or electric shock.

- Don't place too much food directly against the air outlet on the rear wall of both the refrigerator and freezer compartment, as it affects sufficient air circulation.

- Don't place hot items near the plastic components of this appliance.

Frozen food must not be refrozen once it has been thawed out.

- Don't store bottled or canned drinks (especially carbonated drinks) in the freezer compartment. Bottles and cans may explode.
- Don't consume ice popsicles or ice cubes straight from the freezer as this can cause freezer burn to the mouth and lips.
- To avoid items falling and causing injury or damage to the appliance, don't overload the door racks or put too much food in the crisper drawers.

Warning

- Keep ventilation openings, in the appliance enclosure or in the built-in structure, clear of obstruction.
- Don't use mechanical devices or other means to accelerate the defrosting process, other than those recommended by the manufacturer.
- Don't damage the refrigerant circuit.
- Don't use electrical appliances inside the food storage compartments of the appliance, unless they are of the type recommended by the manufacturer.
- If the supply cord is damaged, it must be replaced by the manufacturer, its service agent or similarly qualified persons in order to avoid a hazard.
- When disposing of the appliance, do so only at an authorized waste disposal centre. Don't expose to flame.

Safety for children and infirm persons



This appliance is not intended for use by persons (including children) with reduced physical, sensory or mental capabilities, or a lack of experience and knowledge, unless they have been given supervision or instruction concerning the use of the appliance by a person responsible for their safety. Children should be supervised to ensure that they do not play with the appliance.

- Keep all packaging away from children to avoid risk of suffocation.
- Protect children from being scalded by touching the very hot compressor at the rear bottom of appliance
- Don't place items on top of the appliance as this could cause injury should they fall off.
- Never allow children to play with the appliance by hanging or standing over or on the doors, racks, shelves and drawers etc.

Safety about electricity



To avoid the risks that are always present when using an electric appliance, we recommend that you pay attention to the instructions about electricity below.

- We recommend after you unpack the appliance and check through the appliance. Should any damage be evident, don't plug in the appliance but contact the shop immediately from which you purchased it. Keep all packing materials in this case.
- The appliance must be applied with single phase alternating current of 220~240V/50Hz.
- The mains plug must be accessible when the appliance is installed.
- Make sure that the appliance is grounded properly. If still in doubt, call a qualified registered electrician.
- If the fitted plug is not suitable for your socket outlets, it should be cut off and carefully disposed of. To avoid a possible shock hazard, do not insert the discarded plug into a socket. If in doubt contact a qualified, registered electrician.
- Do not use extension cords or multiple sockets which could cause overloading of wiring circuits and could cause a fire.
- Always plug your appliance into its own individual electrical socket which has a voltage rating that matched the rating plate.
- Make sure that the plug is not squashed or damaged. Otherwise, it may cause short circuit, electric shock or overheat and even cause a fire.

- Don't insert the mains plug if the socket is loose, there is a risk of electric shock or fire.
- Switch off the appliance and disconnect it from the mains power before you clean or move it.
- Never unplug the appliance by pulling on the electrical cord. Always grip the plug firmly and pull straight out from the socket to prevent damaging the power cord.
- Don't use the appliance without the light cover of interior lighting.
- Any electrical component must be replaced or repaired by a qualified electrician or authorized service engineer. Only genuine spares should be used.
- Don't use electrical appliances (such as ice cream makers) inside the food storage compartments of the appliance, unless they are approved by the manufacturer.

Refrigerant

The refrigerant isobutene (**R600a**) is contained within the refrigerant circuit of the appliance, a natural gas with a high level of environmental compatibility, which is nevertheless flammable. During transportation and installation of the

appliance, ensure that none of the components of the refrigerant circuit becomes damaged.

The refrigerant (R600a) is flammable.



Caution: risk of fire

- Don't store products which contain flammable propellants (e.g. spray cans) or explosive substances in the appliance.

Should the refrigerant circuit be damaged:

- Avoid opening flames (candles, lamps etc.) and sources of ignition.
- Thoroughly ventilate the room in which the appliance is situated.

Service Note

This appliance employs Hydrocarbon Refrigerant type R600a.

It is hazardous for anyone other than an Authorized Service Person to service this appliance. In Queensland the authorized Service Person MUST hold a Gas Work Authorization for hydrocarbon refrigerants to carry out servicing or repairs which involve removal of covers.

Installing your new appliance

Before using the appliance for the first time, you should be informed of the following tips.

Ventilation of appliance



In order to improve efficiency of the cooling system and save energy, it is necessary to maintain good ventilation around the appliance for the dissipation of heat. For this reason, sufficient clear space should be available around the refrigerator. Suggest: It is advisable for there to be at least 75mm of space from the back to the wall, at least 100mm from its

top, at least 100mm from its side to the wall and a clear space in front to allow the doors to open 145°. As shown in following diagrams.

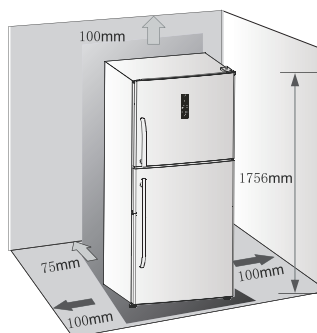

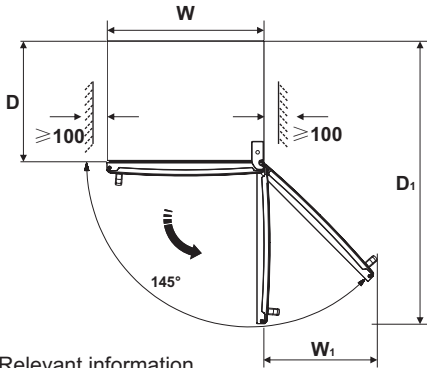

Relevant information

Model	Constant /mm	W	W ₁	D	D ₁
HR6TFF437SD		680	552	600	1306
HR6TFF527SD HR6TFF531SD		790	638	600	1416

Note:

This appliance performs well within the climate class showed in the table below.

It may not work properly if being left at a temperature above or below the indicated range for a long period.

Class	Symbol	Ambient Temperature range(°C)
Extended Temperate	SN	+10 to +32
Temperate	N	+16 to +32
Subtropical	ST	+16 to +38
Tropical	T	+16 to +43

- Stand your appliance in a dry place to avoid high moisture.
- Keep the appliance out of direct sunlight, rain or frost. Stand the appliance away from heat sources such as stoves, fires or heaters.

Leveling of appliance

The appliance should be level in order to eliminate vibration. We recommend that you level the appliance by the following steps.

1. Roll the refrigerator into place.
2. Turn the adjustable feet (with your fingers or a suitable spanner) until it touches the floor.

3. Tilt back the top backwards for about 10-15 mm by turn the feet 1-2 turn further. This will allow the doors to self-close, providing a consistent closed seal.

4. Whenever you want to move the appliance, remember to turn the feet back up so that the appliance can roll freely. Reinstall the appliance when relocating.

Caution! The rollers, which are not castors, should be only used for forward or backward movement. Moving the refrigerator sideways may damage your floor and the rollers.

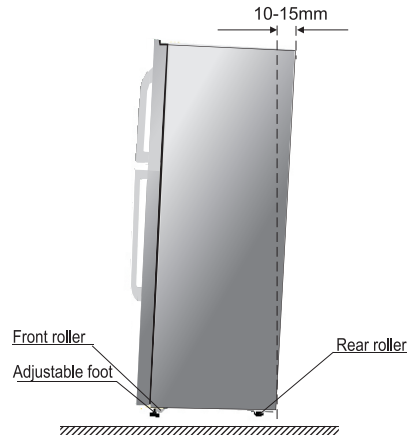

Fixing the handle

Before you use the product, please check the handle of the refrigerator. If the handle is loose, you should fix it with the hexangular screwdriver in the clockwise direction, then it can be used normally.

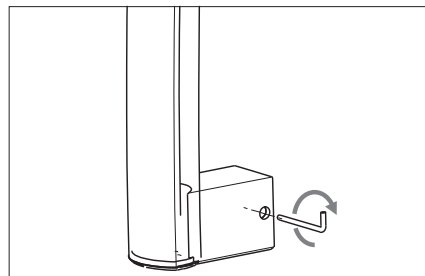

Description of the appliance

View of the appliance (HR6TFF437SD)

- 1 Light cover
- 2 LED light (inside)
- 3 Screw hole cover
- 4 Wind channel part in freezer chamber
- 5 Shelf part
- 6 Ice tray part
- 7 Ice box
- 8 Light cover
- 9 LED light (inside)
- 10 Wind channel part in refrigerator chamber
- 11 Shelf part
- 12 Shelves assembly
- 13 Multifunctional drawer
- 14 Shelves assembly
- 15 Crisper box part
- 16 Roll wheel
- 17 Adjustable bottom feet part
- 18 Upper hinge cover
- 19 Door switch
- 20 Freezer door rack
- 21 Gasket part
- 22 Middle hinge part
- 23 Shelf cover
- 24 Egg tray
- 25 Small shelf
- 26 Door switch
- 27 Refrigerator door rack(middle)
- 28 Gasket part
- 29 Refrigerator door rack(lower)

FREEZER

REFRIGERATOR

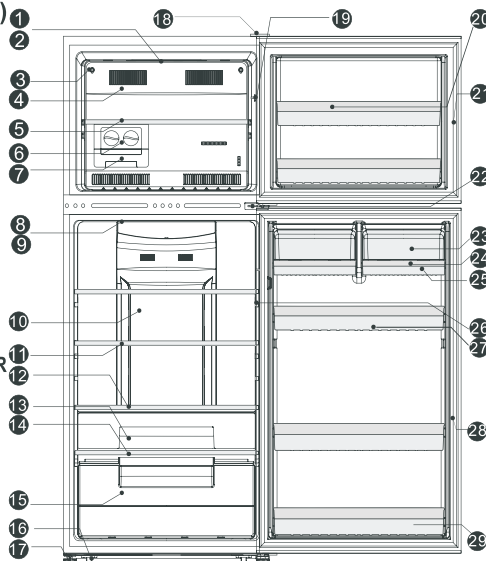

Note: Due to unceasing modification of our products your refrigerator may be slightly different from this Instruction Manual, but its functions and using methods remain the same.

View of the appliance(HR6TFF527SD\HR6TFF534SD)

- 1 Light cover
- 2 LED light (inside)
- 3 Screw hole cover
- 4 Wind channel part in freezer chamber
- 5 Shelf part
- 6 Ice tray part
- 7 Ice box
- 8 Light cover
- 9 LED light (inside)
- 10 Wind channel part in refrigerator chamber
- 11 Shelf part
- 12 Shelves assembly
- 13 Multifunctional drawer
- 14 Shelves assembly
- 15 Crisper box part
- 16 Roll wheel
- 17 Adjustable bottom feet part
- 18 Upper hinge cover
- 19 Door switch
- 20 Freezer door rack
- 21 Gasket part
- 22 Middle hinge part
- 23 Shelf cover
- 24 Egg tray
- 25 Small shelf
- 26 Door switch
- 27 Refrigerator door rack(middle)
- 28 Gasket part
- 29 Refrigerator door rack(lower)
- 30 Bottle holder

FREEZER

REFRIGERATOR

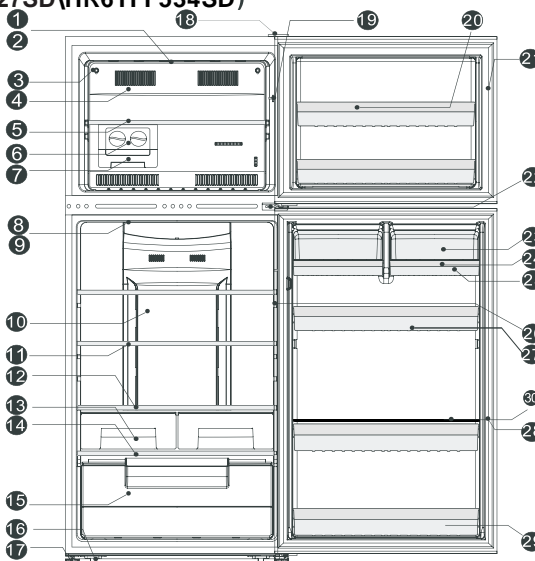

Note: Due to unceasing modification of our products your refrigerator may be slightly different from this Instruction Manual, but its functions and using methods remain the same.

Display controls

All functions and controls of the unit are accessible from a control panel conveniently located on the door of the refrigerator. A keypad of touch buttons and a digital display allow easy configuration of features and settings in a simple and intuitive manner.

Important! Touch buttons require only a short press on a button to operate. The operation occurs when releasing your finger from the button, not while the button is pressed. There is no need for applying pressure on the keypad.

"Holiday" and "Alarm" buttons require a long touch of at least 3 sec.

Please refer to those related sections of this Manual for detailed instructions.

The control panel consists of two indicating temperature areas, four icons representing different modes and six touch buttons. When the appliance is powered on for the first time, the backlight of the icons on display panel turns on. If no buttons have been pressed and the doors remains closed, the backlight will turn off after 60 sec.

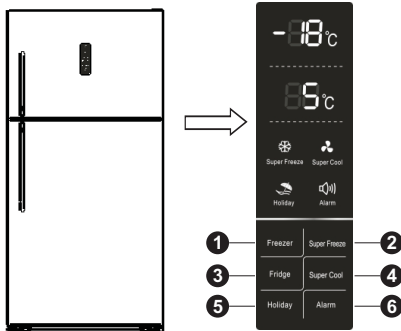

Controlling the temperature

We recommend that when you start your refrigerator for the first time, the temperature for the refrigerator is set to 5°C and the freezer to -18°C. If you want to change the temperature, follow the instructions below.

Caution! When you set a temperature, you set an average temperature for the whole refrigerator cabinet.

Temperatures inside each compartment may vary from the

temperature values displayed on the panel, depending on how much food you store and where you place them. Ambient temperature may also affect the actual temperature inside the appliance.

1. Freezer

Press "Freezer" to set freezer temperature between -14°C and -24°C as needed, and the control panel will display corresponding value according to the following sequence.

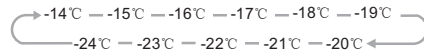

2. Super Freeze

Super Freeze can quickly lower frozen temperature and freeze your food faster than usual. This feature also helps to keep the vitamins and nutrition of fresh food for longer period.

- Press "Super Freeze" button to activate the super freeze function. The light will come on and the freezer temperature setting displays -24°C.

- In case of the maximum amount of food to be frozen, we recommend that you let the appliance operates for 6 hours first.

- Super freeze automatically switches off after 26 hours and the freezer temperature goes to below -20°C.

- When super freeze function is on you can switch off super freeze function by pressing "Super Freeze" or "Freezer" button and the freezer temperature setting will revert back to it's previous setting.

3. Fridge

Press "Fridge" button repeatedly to set your desired fridge temperature between 8°C and 2°C, the temperature will increase 1°C degrees with each press and the fridge temperature indicator will display corresponding value according to the following sequence.

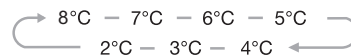

4. Super Cool



Super Cool can refrigerate the food quicker and keep food fresh for a longer period.

- Press "Super Cool" button to activate this function. The Super Cool icon will light up and the Fridge temperature indicator will display 2°C.

Super cool automatically switches off after 6 hours.

- Press "Super Cool" or "Fridge" to cancel super cool mode and revert to previous temperature settings.

5. Holiday



This function is designed to minimise the energy consumption and electricity bills while the Fridge is not in use for a long period of time. You can activate this function by pressing "Holiday" button for a short until the Holiday light icon is illuminated.

Important! Do not store any food in the refrigerator chamber during this time.

- When the holiday function is activated, the temperature of the refrigerator is automatically switched to 15°C to minimise the energy consumption. The refrigerator temperature setting displays "-" and the freezer compartment remains on.

- Press "Holiday" button to cancel Holiday mode and revert to previous temperature settings.

6. Alarm



In case of alarm, "Alarm" icon will light up and a buzzing sound will start.

Press "Alarm" button to stop alarm and buzzing then "Alarm" icon will turn off.

Caution! When the refrigerator is turned on after a period of inactivity, the Alarm may be activated. In this case, press "Alarm" button to cancel it.

Door Alarm

The alarm light on and a buzzing sound indicate abnormal conditions, such as accidentally a door left open or that a power interruption to the unit has occurred.

- Leaving any door of refrigerator or freezer open for over 2 minutes will activate a door alarm and buzzer. The buzzer will beep 3 times per minute for 10 minutes. Closing the door cancels the door alarm and buzzer.

- To save energy, please avoid keeping doors open for a long time when using refrigerator. The door alarm can also be cleared by closing the doors.

Temperature alarm

This is an important feature that alerts users of potential damage to stored food. If a power failure occurs, for example a blackout in your area of residence while you are away, the temperature alarm will memorize the temperature of the freezer when power was restored to the unit; this is likely to be the maximum temperature reached by frozen items.

Using your appliance

This section explains that how to use the refrigerator features. We recommend that you read through carefully before using the appliance.

Door rack

The refrigerator chamber is fitted with door racks suitable for storing canned liquid, bottled drinks and packed food. Do not place a large amount of heavy food and items inside door racks.

- The middle door rack is designed to adjust at different heights according to your requirements. Please empty the rack before lifting upward to remove it. Then reposition the rack at the desired height.

Note: There is an egg tray provided that should be located in the upper rack.

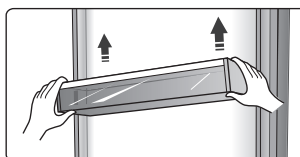

Bottle holder

The bottle holder can be used to fix the bottle.

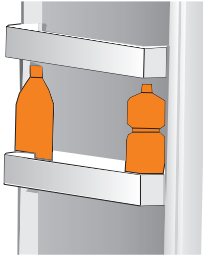

Note: There is a bottle holder in the lower rack.

Shelf in Refrigerator chamber

There are shelves in refrigerator chamber, and they can be taken out to be cleaned.

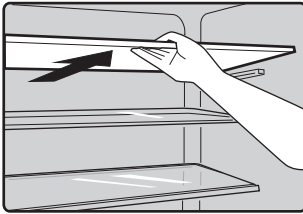

Crisper and Humidity control

The crisper is for storing vegetables and fruits. You can adjust the humidity inside by using the sliding block.

- The sliding block on crisper cover can slide to left or right and the air hole become more or less relatively. More air hole opening means less humidity and less means more humidity.
- We recommend that you store vegetables with more humidity and fruit less humidity.

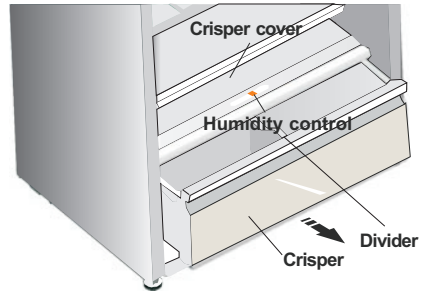

● When you remove the crisper, pull them forward, then lift the crisper off the slides. Remember to empty food in the crisper firstly. Once you have removed the drawers, ensure the slides are pushed back fully.

● Divider easily manage crisper space as you store separate food.

Twistable ice tray

The twistable ice tray is used to make and deposit ice cubes. You should use it as follows.

1. Pull out the twistable ice tray from the installation bracket.
2. Fill the drinking water inside (do not fill above the max water level).
3. Place the filled ice tray back to the bracket.
4. Await for around 3 hours, twist the knobs clockwise and the ice will drop into the ice box below.

Notice :

Ice box is inadvisable to be used to make ice, otherwise it may crack. If it takes a long time to make ice, do not hold the ice tray directly to avoid the ice tray sticking and hurting your hands.

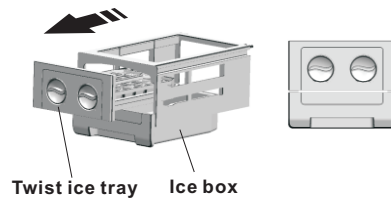

Helpful hints and tips

Energy saving tips

We recommend that you follow the tips below to save energy.

- Try to avoid keeping the door open for long periods in order to conserve energy.
- Ensure the appliance is away from any sources of heat (Direct sunlight, electric oven or cooker etc)
- Don't set the temperature colder than necessary.
- Don't store warm food or evaporating liquid in the appliance.
- Place the appliance in a well ventilated, humidity free, room. Please refer to Installing your new appliance chapter.
- If the diagram shows the correct combination for the drawers, crisper and shelves, do not adjust the combination as this is designed to be the most energy efficient configuration.

Hints for fresh food refrigeration

- Do not place hot food directly into the refrigerator or freezer, the internal temperature will increase resulting in the compressor having to work harder and will consume more energy.
- Do cover or wrap the food, particularly if it has a strong flavor.
- Place food properly so that air can circulate freely around it.

Hints for refrigeration

- Meat (All Types) Wrap in polythene food: wrap and place on the glass shelf above the vegetable drawer. Always follow food storage times and use by dates suggested by manufacturers.
- Cooked food, cold dishes, etc.: They should be covered and may be placed on any shelf.
- Fruit and vegetables: They should be stored in the special drawer provided.
- Butter and cheese: Should be wrapped in airtight foil or plastic film wrap.

film wrap.

- Milk bottles:

Should have a lid and be stored in the door racks.

Hints for freezing

- When first starting-up or after a period out of use, let the appliance run at least 2 hours on the higher settings before putting food in the compartment.
- Prepare food in small portions to enable it to be rapidly and completely frozen and to make it possible to subsequently thaw only the quantity required.
- Wrap up the food in aluminum foil or polyethylene food wraps which are airtight,
- Do not allow fresh, unfrozen food to touch the food which is already frozen to avoid temperature rise of the latter.
- Iced products, if consumed immediately after removal from the freezer compartment, will probably cause frost burns to the skin.
- It is recommended to label and date each frozen package in order to keep track of the storage time.

Hints for the storage of frozen food

- Ensure that frozen food has been stored correctly by the food retailer
- Once defrosted, food will deteriorate rapidly and should not be re-frozen. Do not exceed the storage period indicated by the food manufacturer.

Switching off your appliance

If the appliance needs to be switched off for an extended period, the following steps should be taken prevent mould on the appliance.

1. Remove all food.
2. Remove the power plug from the mains socket.
3. Clean and dry the interior thoroughly.
4. Ensure that all the doors are wedged open slightly to allow air to circulate.

Cleaning and care

For hygienic reasons the appliance (including exterior and interior accessories) should be cleaned regularly at least every two months.

Caution! The appliance must not be connected to the mains during cleaning. Danger of electrical shock! Before cleaning switch the appliance off and remove the plug from the mains socket.

Exterior cleaning

To maintain good appearance of your appliance, you should clean it regularly.

-Wipe the digital panel and display panel with a clean, soft cloth.

-Spray water onto the cleaning cloth instead of spraying directly on the surface of the appliance. This helps ensure an even distribution of moisture to the surface.

-Clean the doors, handles and cabinet surfaces with a mild detergent and then wiped dry with a soft cloth.

Caution!

-Don't use sharp objects as they are likely to scratch the surface.

-Don't use Thinner, Car detergent, Clorox, ethereal oil, abrasive cleansers or organic solvent such as Benzene for cleaning. They may damage the surface of the appliance and may cause fire.

Interior cleaning

You should clean the appliance interior regularly. It will be easier to clean when food stocks are low. Wipe the inside of the fridge freezer with a weak solution of bicarbonate of soda, and then rinse with warm water using a wrung-out sponge or cloth. Wipe completely dry before replacing the shelves and baskets.

Thoroughly dry all surfaces and removable parts.

Although this appliance automatically defrosts, a layer of frost may occur on the freezer compartment's interior walls if the freezer door is opened frequently or kept open too long. If the frost is too thick, choose a time when the supply of food stocks are low and proceed as follows:

1. Remove existing food and accessories baskets, unplug the appliance from the mains power and leave the doors open. Ventilate the room thoroughly to accelerate the thawing process.

2. When defrosting is completed, clean your freezer as described above.

Caution! Don't use sharp objects to remove frost from the freezer compartment. Only after the interior is completely dry should the appliance be switched back on and plugged back into the mains socket.

Door seals cleaning

Take care to keep door seals clean. Sticky food and drinks can cause seals to stick to the cabinet and tear when you open the door. Wash seal with a mild detergent and warm water. Rinse and dry it thoroughly after cleaning.

Caution! Only after the door seals are completely dry should the appliance be powered on.

Replacing the LED light:

Warning: The LED light must not be replaced by the user! If the LED light is damaged, contact the customer helpline for assistance. To replace the LED light, the below steps can be followed:

1. Unplug your appliance.
2. Remove light cover by pushing up and out.
3. Hold the LED cover with one hand and pull it with the other hand while pressing the connector latch.
4. Replace LED light and snap it correctly in place.

Troubleshooting

If you experience a problem with your appliance or are concerned that the appliance is not functioning correctly, you can carry out some easy checks before calling for service, please see below. You can carry out some easy checks according to this section before calling for service.

Warning! Don't try to repair the appliance yourself. If the problem persists after you have made the checks mentioned below, contact a qualified electrician, authorized service engineer or the shop where you purchased the product.

Problem	Possible cause & Solution
Appliance is not working correctly	Check whether the power cord is plugged into the power outlet properly.
	Check the fuse or circuit of your power supply, replace if necessary.
	The ambient temperature is too low. Try setting the chamber temperature to a colder level to solve this problem.
	It is normal that the freezer is not operating during the automatic defrost cycle, or for a short time after the appliance is switched on to protect the compressor.
Odours from the compartments	The interior may need to be cleaned
	Some food, containers or wrapping cause odours.
Noise from the appliance	The sounds below are quite normal: <ul style="list-style-type: none"> ● Compressor running noises. ● Air movement noise from the small fan motor in the freezer compartment or other compartments. ● Gurgling sound similar to water boiling. ● Popping noise during automatic defrosting. ● Clicking noise before the compressor starts.
	Other unusual noises are due to the reasons below and may need you to check and take action: <p>The cabinet is not level.</p> <p>The back of appliance touches the wall.</p> <p>Bottles or containers fallen or rolling.</p>
The motor runs continuously	It is normal to frequently hear the sound of the motor, it will need to run more when in following circumstances: <ul style="list-style-type: none"> ● Temperature setting is set colder than necessary ● Large quantity of warm food has recently been stored within the appliance. ● The temperature outside the appliance is too high. ● Doors are kept open too long or too often. ● After your installing the appliance or it has been switched off for a long time.
A layer of frost occurs in the compartment	Check that the air outlets are not blocked by food and ensure food is placed within the appliance to allow sufficient ventilation. Ensure that door is fully closed. To remove the frost, please refer to cleaning and care chapter.

Temperature inside is too warm	You may have left the doors open too long or too frequently; or the doors are kept open by some obstacle; or the appliance is located with insufficient clearance at the sides, back and top
Temperature inside is too cold	Increase the temperature by following the "Display controls" chapter.
Doors cant be closed easily	Check whether the top of the refrigerator is tilted back by 10-15mm to allow the doors to self close, or if something inside is preventing the doors from closing.
Water drips on the floor	The water pan (located at the rear bottom of the cabinet) may not be properly leveled, or the draining spout (located underneath the top of the compressor depot) may not be properly positioned to direct water into this pan, or the water spout is blocked. You may need to pull the refrigerator away from the wall to check the pan and spout.
The light is not working	<ul style="list-style-type: none"> ●The LED light may be damaged. Refer to replace LED lights in cleaning and care chapter. ●The control system has disabled the lights due to the door being kept open too long, close and reopens the door to reactivate the lights.

Disposal of the appliance

It is prohibited to dispose of this appliance as household waste.

Packaging materials

Packaging materials with the recycle symbol are recyclable. Dispose of the packaging into a suitable waste collection container to recycle it.

Before disposal of the appliance

1. Pull out the mains plug from the mains socket.
2. Cut off the power cord and discard with the mains plug

Warning! Refrigerators contain refrigerant and gases in the insulation. Refrigerant and gases must be disposed of professionally as they may cause eye injuries or ignition.

Ensure that tubing of the refrigerant circuit is not damage prior to proper disposal.

	Correct Disposal of this product
	<p>This symbol on the product or in its packing indicates that this product may not be treated as household waste. Instead, it should be taken to the appropriate waste collection point for the recycling of electrical and electronic equipment. By ensuring this product is disposed of correctly, you will help prevent potential negative consequences for the environment and human health, which could otherwise be caused by the inappropriate waste handling of this product. For more detailed information about the recycling of this product, please contact your local council your household waste disposal service, or the shop where you purchased the product.</p>

Hisense

life reimagined