

4Kg Clothes Dryer Manual

MODEL

DM4KG

Euromaid

Installation and Operation

Troubleshooting

Review the following pages before calling for service.

Problem	Possible Cause	What to do
Timer knob does not turn	<ul style="list-style-type: none"> Is the power cord inserted firmly? 	<ul style="list-style-type: none"> Insert the power cord firmly
Drum does not turn	<ul style="list-style-type: none"> Is the door closed? Is the power cord inserted? Does the receptacle have power? 	<ul style="list-style-type: none"> Close the door. Insert the power cord firmly. Check the power cord receptacle.
Hot air is not blowing out	<ul style="list-style-type: none"> Is the timer incorrectly set on cold air? 	<ul style="list-style-type: none"> Set the timer to hot air.
The laundry is not thoroughly dried	<ul style="list-style-type: none"> Are the front and back filters clogged? Is there too much laundry in the dryer? Have items been added whilst the dryer is in operation? Has the laundry become twisted whilst drying? Has the dryer been placed in a small and badly ventilated area? Have you set the dryer to Anti-Wrinkle? 	<ul style="list-style-type: none"> Clean the filter. Reduce the amount in the dryer. Re-dry the items again Untwist the items and re-dry. Place the dryer in a well-ventilated area. Try using 'Warm' or 'Hot' setting instead
Dryer does not start	<ul style="list-style-type: none"> Is there a power failure? Is the power cord inserted firmly? Is the door closed? Is the timer in the OFF position? 	<ul style="list-style-type: none"> Try again when there is power Insert the power cord firmly Close the door Set the dry time

Model	DM4KG
Drying Capacity	4.0Kg
Voltage	220-240V~ 50Hz
Rated Input	1400W / 800 W High / Low
Net Weight	20Kg
Dimensions	600mm × 435mm × 700mm

NOTE: Consistent with our continuing product development policy, improvements may have been made which render the contents of this package slightly different to that shown.

Euromaid

4KG REVERSIBLE WALL MOUNTED DRYER

MODEL: DM4KG

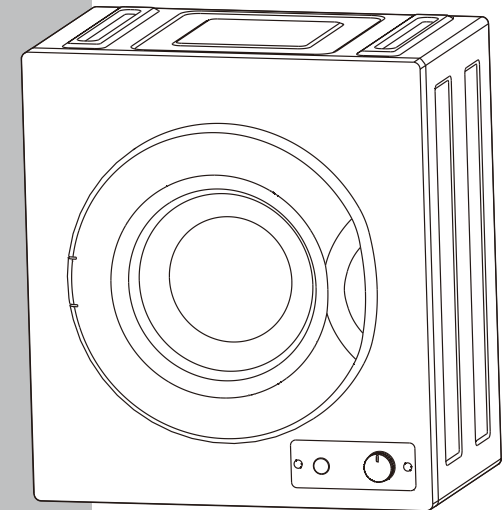

Instruction Manual

Important Safeguards

When using electrical appliances, in order to reduce the risk of fire, electric shock, and/or injury to persons, basic safety precautions should always be followed, including:

For Your Safety

Read all instructions carefully, even if you are quite familiar with the appliance.

- This appliance is not intended for use by persons (including children) with reduced physical, sensory or mental capabilities, or lack of experience and knowledge, unless they have been given supervision or instruction concerning use of the appliance by a person responsible for their safety.
- Young children should be supervised to ensure that they do not play with the appliance.
- INDOOR USE ONLY – this appliance is not intended for outdoor use.
- Do not place naked flame sources, such as candles, on the appliance.
- Do not locate the appliance or cord near heat sources such as radiators, heaters, air ducts or direct sunlight.
- Do not block any of the ventilation openings. Ensure that vents are not covered by newspapers, tablecloths, curtains, etc.
- Do not run the cord under floor coverings. Instead, arrange the cord away from traffic areas where it will not become a trip hazard.
- To disconnect the appliance, turn the appliance off, switch off the power outlet and remove the plug from the power outlet.
- Do not misuse the cord. Never carry the appliance by the cord or pull to disconnect it from the outlet. Instead, grasp the plug and pull to disconnect.
- Do not operate the appliance if it has a damaged cord or plug; after the appliance malfunctions; or has been dropped or damaged in any way. Consult the manufacturer.
- Do not attempt to repair, disassemble or modify this appliance. The warranty becomes void if not serviced or repaired by a qualified person.
- Do not place items that have been soiled with flammable liquids inside the dryer without washing them with detergent thoroughly before hand.
- Do not excessively bend, stretch, twist or bind the power cord or place heavy objects on it.
- Do not use an extension cord with this appliance.

- This appliance is only to be serviced by a qualified person. There are no user-serviceable parts inside.
- Do not install in a tight fitting cabinet.
- Do not overload the tumble dryer.
- Ensure foreign objects do not find their way into the tub of the tumble dryer.
- The door window may be hot after a long drying cycle. Please ensure children are kept away from the machine.
- If the tumble dryer is not wall mounted, place in a flat, firm, dry and drafty place. Use the adjustable front legs to assist in leveling the dryer if need be. Do not place it on any soft material such as foam or plastic.
- Do not use flammable or combustible materials such as gas, petrol, alcohol or lacquer in the tumble dryer.
- After turning off the power supply to the tumble dryer, wait at least 2 minutes before turning it back on again.
- Please remove the transport packaging at the rear of the tumble dryer, prior to use.
- If the supply cord is damaged, it must be replaced by the manufacturer, its service agent or similarly qualified persons in order to avoid a hazard.

CAUTION: If this appliance is supplied from a cord extension set or an electrical portable outlet device, the cord extension set or electrical portable outlet device must be positioned so that it is not subject to splashing or ingress of moisture.



- Oil-affected items can ignite spontaneously, especially when exposed to heat sources such as in a tumble dryer. The items become warm, causing an oxidation reaction in the oil. Oxidation creates heat. If the heat cannot escape, the items can become hot enough to catch fire. Piling, stacking or storing oil-affected items can prevent heat from escaping and so create a fire hazard.

Save These Instructions

Maintenance

Cleaning the Lint Filter

Please unplug the power cord prior to any cleaning. The lint filter must be in place whenever drying. It must be cleaned before each use.

1. Removing the filters

Remove by pulling outwards with fingers, inserted into the four holes around the exhaust vent shroud. The filter is in 3 parts: Exhaust vent shroud, lint filter and exhaust filter (as shown in figure 1)

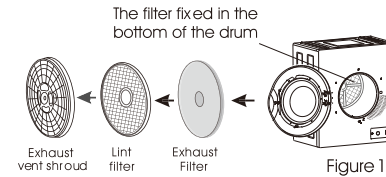

2. Cleaning the filter

Separate "exhaust vent shroud", "lint filter" and "exhaust filter". Clean the lint on the lint filter and exhaust filter with a soft brush or vacuum cleaner. Do not damage the filters (as shown in figure 2)

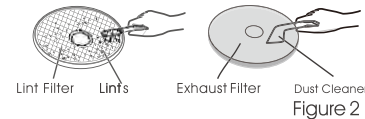

3. Re-installing the filter

After cleaning, assemble in the sequence of "exhaust filter - lint filter - exhaust vent shroud", align the recesses in the center with the projection in the center of the drum. Make sure that it is firmly inserted (as shown in figure 3).

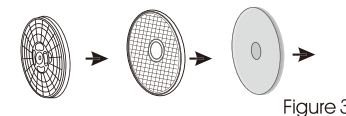

Note: The filter fixed in the bottom of the drum should also be cleaned with a soft brush.

Cleaning of the Air Intake Filter

The filter should be cleaned once a month.

Remove by pulling outwards holding the upper and lower ends of the air intake shroud. Remove the filter inside the shroud and clean it with a soft brush. Reassemble and install as before.

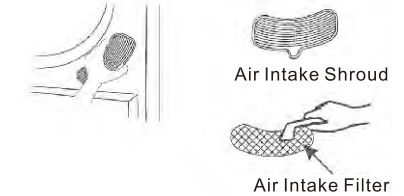

Slightly push upwards with your thumb until the latch hook disconnects, then remove.

Cleaning the interior & exterior of the Dryer

Do not wash directly with water. Do not use thinner, gasoline or alcohol. Do not use any type of spray cleaner when cleaning the interior. If dryer drum becomes stained, clean the drum with a damp cloth. Remove any residue before drying the next load. Clean cabinet with mild soap and water. Do not use harsh or abrasive cleaners, this could damage the dryer.

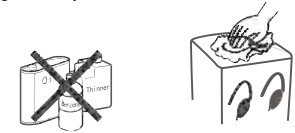

WARNING: Regularly clean the lint trap

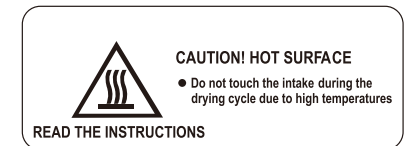

Up-side-down Installation:

For convenient using, this dryer can be up-side-down installation. The installation step as below:

1) Take off the rubber plugs on the top of the unit (as per Fig 6). Then take off the four legs from the bottom (as per Fig 7).

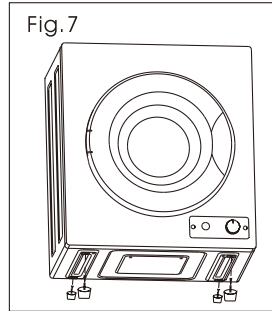
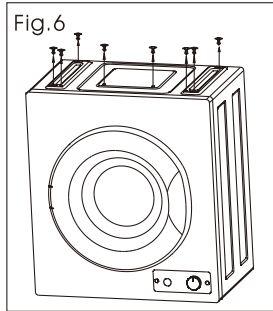

2) Put the dryer up-side-down and install the four legs at the bottom (Top side of the original dryer, as Fig.8). Push rubber plugs inside holes on the top of the dryer (Bottom of the original dryer, as Fig.9)

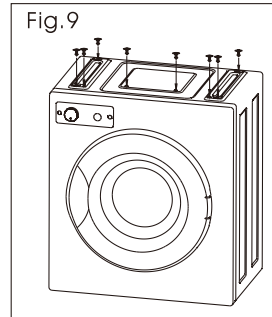
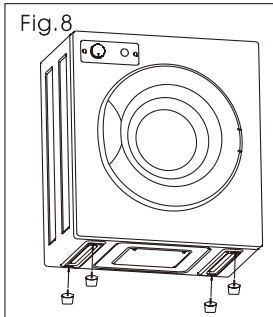

3) There is a printing control panel in the accessories bag. Rip the protected paper and stick it over the existing panel, as per Fig.10.

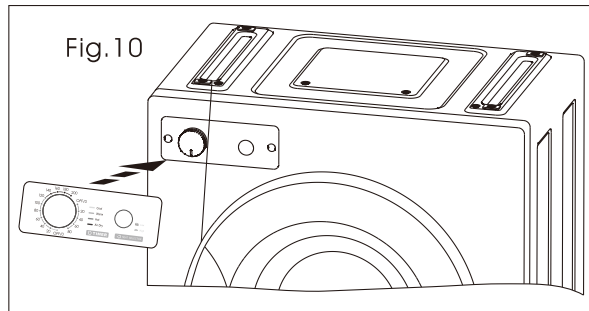

Up-side-down Wall Mounting Installation:

The Up-side-down dryer also can be wall mounted. User can follow "Installation Instructions" and "Wall Mounting Instructions" on the Page 9 and Page 10 to install machine.

- If it is unavoidable that fabrics that contain vegetable or cooking oil or have been contaminated by hair care products be placed in a tumble dryer they should first be washed in hot water with extra detergent - this will reduce, but not eliminate, the hazard.
- Do not dry unwashed items in the tumble dryer.
- Items that have been soiled with substances such as cooking oil, acetone, alcohol, petrol, kerosene, spot removers, turpentine, waxes and wax removers should be washed in hot water with an extra amount of detergent before being dried in the tumble dryer.
- Fabric softeners, or similar products, should be used as specified by the fabric softener instructions.
- The final part of a tumble dryer cycle occurs without heat (cool down cycle) to ensure that the items are left at a temperature that ensures that the items will not be damaged.
- **WARNING:** Never stop a tumble dryer before the end of the drying cycle unless all items quickly removed and spread out so that the heat is dissipated.

Name of Components

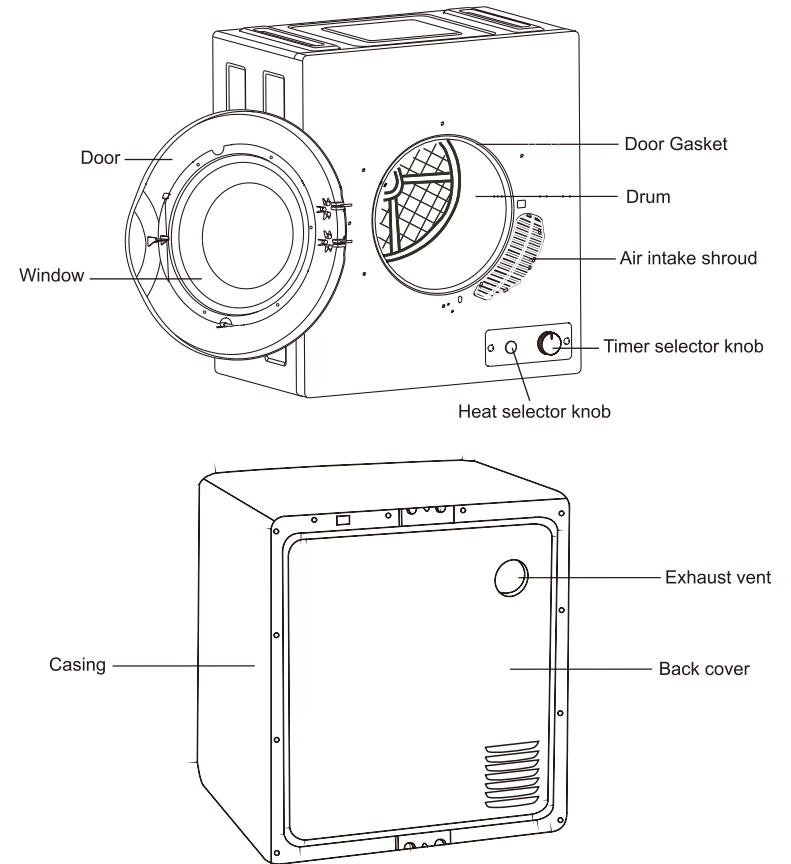

Operating your dryer

Electrical Requirements

The unit is required to be plugged into a three pin socket that is reliably grounded. The power supply must be 220-240V. Plug the power cord into the socket.

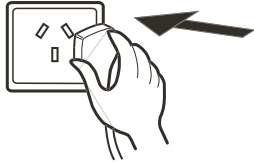

Loading the dryer

It is recommended that items are placed into the dryer one at a time. This ensures they are not tangled which results in uneven drying. When closing the dryer door prior to starting the unit ensure that items are not jammed in the door.

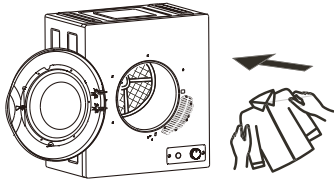

Tips before drying

Prior to loading the dryer check that the items do not have the following the symbols anywhere on them. If they do, do not tumble dry these items.

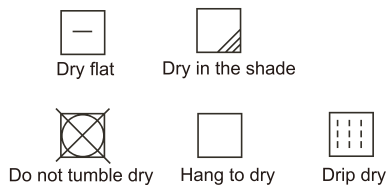

- Check the items to be dried do not have combustible materials or foreign objects within them ie: lighters, hair pins, coins.

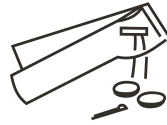

- Turn items with zippers inside out and fasten buckles.



- Dryer heat may permanently set stains, ensure you check prior to drying that stains are removed.
- Separate dark and light colored items as you would do when washing.
- For best results load the dryer with similar fabrics. Place small delicate items in a mesh bag and do not overload the dryer.
- The maximum mass is 4.0 kilogrammes of dry textile material for the dryer and do not overload. The tumble dryer is intended only for drying textile material washed in water.

Drying time reference table

Drying Capacity	Dry time	
	Strong	Soft
Approx.1kg	Approx.30min	Approx.55min
Approx.2kg	Approx.60min	Approx.110min
Approx.3kg	Approx.120min	
Approx.4kg	Approx.200min	

Drying times can be affected by many factors, such as material, bulkiness, how full the dryer is etc. The above list is a guide only.

3. To install the hanging hook to timber, start at Fig 2.
4. Align hanging hooks and fasten screws tightly.
5. Install exhaust pipe: Adjust the direction of the exhaust outlet(1) as shown in Fig. 3.
6. Using 3 x 16mm screws (provided) to fix the outlet in place firmly.
7. Using 4X12 mm screws (provided) to fix the 2 spacers as per Fig4.
8. With assistance, mount dryer on wall bracket. See Fig. 5.

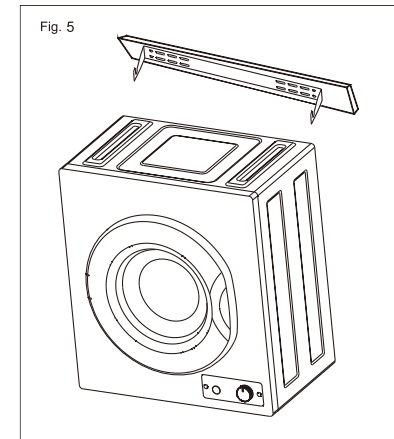
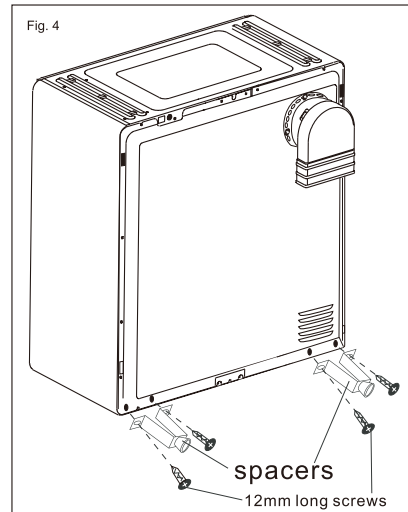
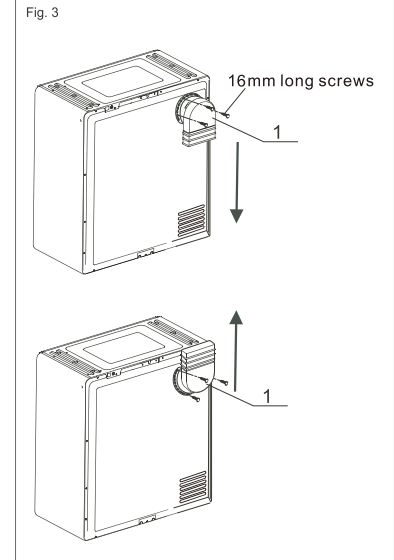
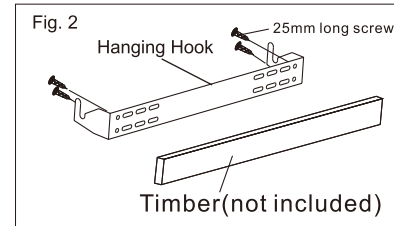

Installation Instructions

Where to place your dryer

Place the dryer in a dry well ventilated area. It should be positioned away from heat and direct sunlight.

If the dryer is not wall mounted, it must be placed on firm horizontal ground. Do not place the dryer on carpet as this will block the intake. There should be at least 10cm between the dryer and the walls.

The dryer comes with fixed legs that need to be assembled to ensure stability.

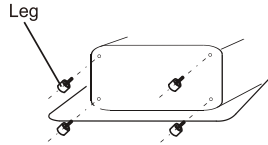

If the dryer is rack mounted. A secure bracket is required to ensure stability and prevent vibration. At least 10cm between the dryer and walls is required (The bracket is not included).

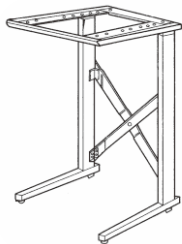
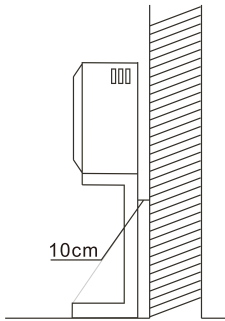

Bracket

Wall Mounting Instructions

1. Determine dryer position on wall and mark required bracket position. This dryer is not suitable to be directly placed on top of a washing machine.

* A minimum 50mm is needed between the top of the dryer and the ceiling for ease of installation.

* If mounting above a washing machine, allow sufficient room to open the lid of the washer.

Tools required		
Tools & parts required for Plaster/ wooden wall	Drill & 3mm Bit	1
	Phillips Head Screw Driver	1
	Wood Screws, ϕ 12x 50mm Timber Screws	4
	Helper to lift dryer onto wall	1

Wall Mounting Kit Includes		
Description	Hanging brackets	1
	Plastic Spacers	2
	Exhaust connector	1
	16mm Long Screws	3
	25mm Long Screws	4
	12mm Long Screws	4

2. Fix the wall hanging brackets (1 supplied) to the wall securely (eg. into the stud.) Fit a timber slat between the studs to mount the brackets onto if the stud position is too wide.

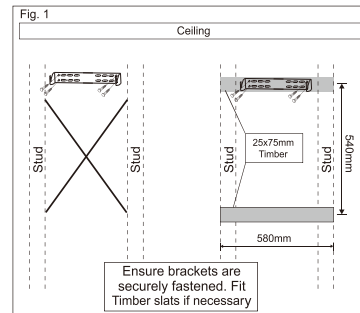
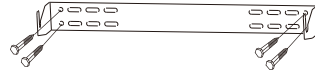

Control Panel Functions

Heat Selector button

Select 'High Dry' for items that are particularly bulky or large quantities.



Select 'Low dry' for delicate items such as Silk, nylon, linen etc.

Drying Program Selector

There are five drying combinations available: Cool, Anti-wrinkle, Warm, Hot and Air dry.

Air Dry: This function runs with cool air, primarily to air items that require freshening i.e.: clothes that have been stored for a long period of time.

Off: When the 'Drying Timer' dial is in the 'Off' position no power is supplied to the unit. As soon as the dial is turned clockwise to the desired program the dryer will start.

Cool: This function is generally used to cool the items that have just been dried. This helps to prevent creasing. Instead of the motor pushing heat into the drum of the dryer it will generate cool air.

Warm: Anti-wrinkle function: This is used for items that are difficult to iron i.e.: cotton shirts and linen. Using the heat selector knob choose 'Low'. Set the drying timer knob between 30 - 60 minutes depending on the amount of items in the dryer. Once the timer stops (including the Cool program) the items will still contain moisture, making the ironing process easier.
Warm drying function: This function will dry and cool items and in most cases leave items wrinkle free (depending on material). Select the 'High' heat option. Set the timer between 60-150 minutes.

Hot: For drying large quantities or bulky items (Dryer drum is more than 1/2 full). Select the 'High' heat option and set the timer for more than 150 minutes.

Operation Precautions

Delicate items should be placed into a nylon net bag prior to drying. It is not recommended to dry underwear bras in this unit.

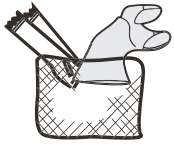

Ensure that foreign objects do not find their way into the dryer. All pockets should be emptied, buttons, buckles and zips fastened. This will also help reduce impact noise when the items hit against the turning drum.



Do not add items into the dryer whilst it is in operation.

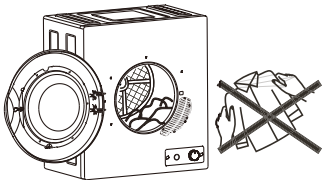

If drying large items such as a blanket, it is recommended that from time to time you open the dryer door, shake the item, place the item back in the dryer and close the door. This will ensure even drying.

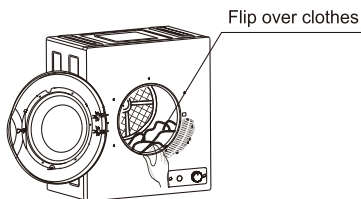

If any of the below labels are on an items that you are going to place in the dryer, stop, do not, as the dryer may damage the item.



Dry flat



Dry in the shade



Do not tumble dry



Hang to dry



Drip dry

Electrical Requirements: A three pin socket must be used. (reliably grounded)

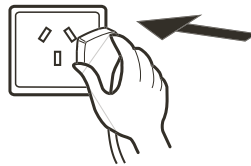

To ensure you get the most out of the Anti-wrinkle function do not overload the dryer and remove the dried items from the dryer immediately and hang on coat hangers. Iron the items if desired.

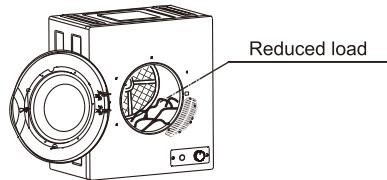

To minimize the risk of fire in a tumble dryer, the following should be observed:

- Items that have been spotted or soaked with vegetable or cooking oil constitute a fire hazard and should not be placed in a tumble dryer.

Oil-affected items can ignite spontaneously, especially when exposed to heat sources such as in a tumble dryer. The items become warm, causing an oxidation reaction in the oil. Oxidation creates heat. If the heat cannot escape, the items can become hot enough to catch fire. Piling, stacking or storing oil-affected items can prevent heat from escaping and so create a fire hazard.

If it is unavoidable that fabrics that contain vegetable or cooking oil or have been contaminated by hair care products be placed in a tumble dryer they should first be washed in hot water with extra detergent - this will reduce, but not eliminate, the hazard.

The 'cool down' cycle of tumble dryers should be used to reduce the temperature of the items. They should not be removed from the tumble dryer or piled or stacked while hot.

Items that have been previously cleaned in, washed in, soaked in or spotted with petrol/gasoline, dry-cleaning solvents or other flammable or explosive substances should not be placed in a tumble dryer.

Highly flammable substances commonly used in domestic environments include acetone, denatured alcohol, petrol/gasoline, kerosene, spot removers (some brands), turpentine, waxes and wax removers.

- Items containing foam rubber (also known as latex foam) or similarly textured rubber, like materials should not be dried in a tumble dryer on a heat setting.

Foam rubber materials can, when heated, produce fire by spontaneous combustion.

- Fabric softeners or similar products should not be used in a tumble dryer to eliminate the effects of static electricity unless this practice is specifically recommended by the manufacturer of the fabric softener or product.
- Undergarments that contain metal reinforcements should not be placed in a tumble dryer.

Damage to the tumble dryer can result if metal reinforcements come loose during drying. When available a drying rack could be used for such items.

- Plastic articles such as shower caps or babies' waterproof napkin covers should not be placed in a tumble dryer.
- Rubber-backed articles, clothes fitted with foam rubber pads, pillows, galoshes and rubber-coated tennis shoes should not be placed in a tumble dryer.