

**installation & operating  
instructions and cooking  
guidance**

**Oven**

**Model GEGFS60  
GEGFW60**

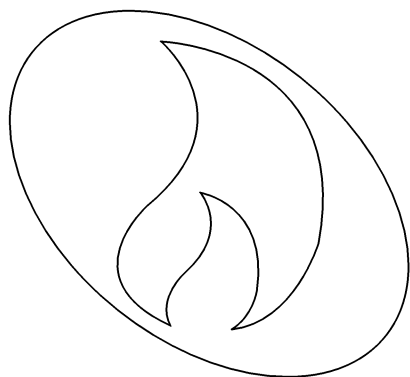

*get the best from your new cooker*

## Please read this user manual first!

Dear Customer,

Thank you for purchasing this Euromaïd product. We hope that you get the best results from your product which has been manufactured with high quality and state-of-the-art technology. Therefore, please read this entire user manual and all other accompanying documents carefully before using the product and keep it as a reference for future use. If you handover the product to someone else, give the user manual as well. Follow all warnings and information in the user manual.

Remember that this user manual is also applicable for several other models. Differences between models will be identified in the manual.

### Explanation of symbols

Through this user manual the following symbols are used:

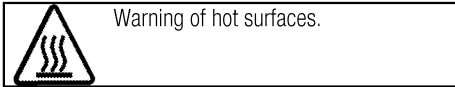
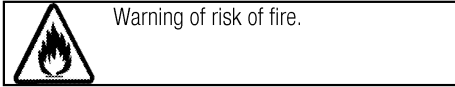
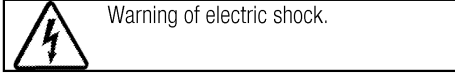
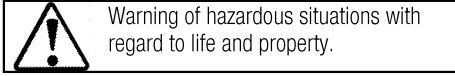
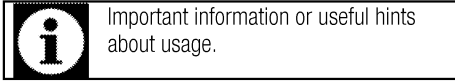

**Arçelik A.Ş.**  
Karaağaç caddesi No:2-6  
34445 Sütlüce/Istanbul/TURKEY  
Made in TURKEY

## TABLE OF CONTENTS

### **1 Important instructions and warnings for safety and environment 4**

General safety.....	4
Safety when working with gas.....	4
Electrical safety.....	5
Product safety.....	6
Intended use.....	7
Safety for children.....	8
Disposing of the old product.....	8
Package information.....	9

### **2 General information 10**

Overview.....	10
Package contents.....	11
Technical specifications.....	12
Injector table.....	13

### **3 Installation 14**

Before installation.....	14
Installation and connection.....	15
Gas conversion.....	17
Future Transportation.....	19

### **4 Preparation 20**

Tips for saving energy.....	20
Initial use.....	20

First cleaning of the appliance.....	20
Initial heating.....	20

### **5 How to use the hob 21**

General information about cooking.....	21
Using the hobs.....	21

### **6 How to operate the oven 23**

General information on baking, roasting and grilling.....	23
How to use the gas oven.....	23
Cooking times table.....	24
How to operate the grill.....	25
Cooking times table for grilling.....	25

### **7 Maintenance and care 26**

General information.....	26
Cleaning the hob.....	26
Cleaning the control panel.....	26
Cleaning the oven.....	26
Removing the oven door.....	27
Replacing the oven lamp.....	27

### **8 Troubleshooting 28**

## **1 Important instructions and warnings for safety and environment**

This section contains safety instructions that will help protect from risk of personal injury or property damage. Failure to follow these instructions shall void any warranty.

### **General safety**

- The appliance is not intended for use by persons (including children) with reduced physical, sensory or mental capabilities, or lack of experience and knowledge, unless they have been given supervised or instruction concerning use of the appliance by a responsible person for their safety.
- Young children should be supervised to ensure that they do not play with the appliance.
- Never place the product on a carpet-covered floor. Otherwise, lack of airflow beneath the product will cause electrical parts to overheat. This will cause problems with your product.
- Installation and repair procedures must always be performed by Authorized Service Agents. The manufacturer shall not be held responsible for damages arising from procedures carried out by unauthorized persons which may also void the warranty. Before

installation, read the instructions carefully.

- Do not operate the product if it is defective or has any visible damage.
- Control that the product function knobs are switched off after every use.

### **Safety when working with gas**

- Any works on gas equipment and systems may only be carried out by authorised qualified persons who are Gas Safe registered.
- Prior to the installation, ensure that the local distribution conditions (nature of the gas and gas pressure) and the adjustment of the appliance are compatible.
- This appliance is not connected to a combustion products or evacuation device. It shall be installed and connected in accordance with current installation regulations. Particular attention shall be given to the relevant requirements regarding ventilation; See *Before installation*, page 14
- The use of gas cooking appliance results in the production of heat and moisture in the room in which it is installed. Ensure that the kitchen is well ventilated: keep

natural ventilation holes open or install a mechanical ventilation device (mechanical extractor hood). Prolonged intensive use of the appliance may call for additional ventilation, for example increasing the level of the mechanical ventilation where present.

- Gas appliances and systems must be regularly checked for proper functioning. Regulator, hose and its clamp must be checked regularly and replaced within the periods recommended by its manufacturer or when necessary.
- Clean the gas burners regularly. The flames should be blue and burn evenly.
- Good combustion is required in gas appliances. In case of incomplete combustion, carbon monoxide (CO) might develop. Carbon monoxide is a colourless, odourless and very toxic gas, which has a lethal effect even in very small doses.
- Request information about gas emergency telephone numbers and safety measures in case of gas smell from you local gas provider.

### **What to do when you smell gas**

- Do not use open flame or do not smoke. Do not operate any electrical buttons (e.g. lamp

button, door bell and etc.) Do not use fixed or mobile phones. Risk of explosion and toxication!

- Open doors and windows.
- Turn off all valves on gas appliances and gas meter at the main control valve, unless it's in a confined space or cellar.
- Check all tubes and connections for tightness. If you still smell gas leave the property.
- Warn the neighbours.
- Call the fire-brigade. Use a telephone outside the house.
- Do not re-enter the property until you are told it is safe to do so.

### **Electrical safety**

- If the product has a failure, it should not be operated unless it is repaired by the Authorized Service Agent. There is the risk of electric shock!
- Only connect the product to a grounded outlet/line with the voltage and protection as specified in the "Technical specifications". Have the grounding installation made by a qualified electrician while using the product with or without a transformer. Our company shall not be liable for any problems arising due to the product not being earthed in accordance with the local regulations.

- Never wash the product by spreading or pouring water onto it! There is the risk of electric shock!
- ever touch the plug with wet hands! Never unplug by pulling on the cable, always pull out by grabbing the plug.
- The product must be unplugged during installation, maintenance, cleaning and repairing procedures.
- If the power connection cable for the product is damaged, it must be replaced by the manufacturer, its service agent or similiary qualified persons in order to avoid a hazard.
- The appliance must be installed so that it can be completely disconnected from the network. The separation must be provided either by a mains plug, or a switch built into the fixed electrical installation, according to construction regulations.
- Rear surface of the oven gets hot when it is in use. Make sure that the gas/electrical connection does not contact the rear surface; otherwise, connections can get damaged.
- Do not trap the mains cable between the oven door and frame and do not route it over hot surfaces. Otherwise, cable insulation may melt and cause fire as a result of short circuit.
- Any work on electrical equipment and systems should only be carried out by authorized and qualified persons.
- In case of any damage, switch off the product and disconnect it from the mains. To do this, turn off the fuse at home.
- Make sure that fuse rating is compatible with the product.

### **Product safety**

- The appliance and its accessible parts become hot during use. Care should be taken to avoid touching heating elements. Children less than 8 years of age shall be kept away unless continuously supervised.
- Never use the product when your judgment or coordination is impaired by the use of alcohol and/or drugs.
- Be careful when using alcoholic drinks in your dishes. Alcohol evaporates at high temperatures and may cause fire since it can ignite when it comes into contact with hot surfaces.
- Do not place any flammable materials close to the product as the sides may become hot during use.
- During use the appliance becomes hot. Care should be taken to avoid touching heating elements inside the oven.

- Keep all ventilation slots clear of obstructions.
- Do not heat closed tins and glass jars in the oven. The pressure that would build-up in the tin/jar may cause it to burst.
- Do not place baking trays, dishes or aluminium foil directly onto the bottom of the oven. The heat accumulation might damage the bottom of the oven.
- Do not use harsh abrasive cleaners or sharp metal scrapers to clean the oven door glass since they can scratch the surface, which may result in shattering of the glass.
- Do not use steam cleaners to clean the appliance as this may cause an electric shock.
- Do not use the product if the front door glass removed or cracked.
- Oven handle is not towel dryer. Do not hang up towel, gloves, or similar textile products when the grill function is at open door.
- Always use heat resistant oven gloves when putting in or removing dishes into/from the hot oven.
- Ensure that the appliance is switched off before replacing the lamp to avoid the possibility of electric shock.
- Unattended cooking on a hob with fat or oil can be dangerous and

may result in fire. NEVER try to extinguish a fire with water, but switch off the appliance and then cover flame e.g. with a lid or a fire blanket.

- Danger of fire: Do not store items on the cooking surfaces.
- Do not use or store flammable materials in the.
- Do not spray aerosols in the vicinity of this appliance while it is in operation.
- Do not modify this appliance.
- Where this appliance is installed in a marine craft or in caravans, it shall not be used as a space heater.

For the reliability of the fire of the product;

- Make sure the plug is fitting to socket as well for not cause to spark.
- Do not use damaged or cutted or extension cable except the original cable.
- Make sure that not whether liquid or moisture on the socket is plugged to product .
- Make sure your gas connection is installed as well for not cause the gas leakage.

### **Intended use**

- This product is designed for domestic use. Commercial use will void the guarantee.

- This appliance is for cooking purposes only. It must not be used for other purposes, for example room heating.
- This product should not be used for warming the plates under the grill, drying towels, dish cloths etc. by hanging them on the oven door handles. This product should also not be used for room heating purposes.
- The manufacturer shall not be liable for any damage caused by improper use or handling errors.
- The oven can be used for defrosting, baking, roasting and grilling food.

### **Safety for children**

- Accessible parts may become hot during use. Young children should be kept away.
- The packaging materials will be dangerous for children. Keep the packaging materials away from children. Please dispose of all parts of the packaging according to environmental standards.
- Electrical and/or gas products are dangerous to children. Keep children away from the product when it is operating and do not allow them to play with the product.
- An additional protective means to avoid contact with the oven door is available. This part should be

fitted when young children are likely to be present.

- Do not place any items above the appliance that children may reach for.
- When the door is open, do **not** load any heavy object on it and do **not** allow children to sit on it. It may overturn or door hinges may get damaged.

### **Disposing of the old product**

#### **Compliance with the WEEE Directive and Disposing of the Waste Product:**



This product complies with EU WEEE Directive (2012/19/EU). This product bears a classification symbol for waste electrical and electronic equipment (WEEE).

This product has been manufactured with high quality parts and materials which can be reused and are suitable for recycling. Do not dispose of the waste product with normal domestic and other wastes at the end of its service life. Take it to the collection center for the recycling of electrical and electronic equipment. Please consult your local authorities to learn about these collection centers.

#### **Compliance with RoHS Directive:**

The product you have purchased complies with EU RoHS Directive



(2011/65/EU). It does not contain harmful and prohibited materials specified in the Directive.

**Package information**

- Packaging materials of the product are manufactured from recyclable materials in accordance with our National

Environment Regulations. Do not dispose of the packaging materials together with the domestic or other wastes. Take them to the packaging material collection points designated by the local authorities.

## 2 General information

### Overview

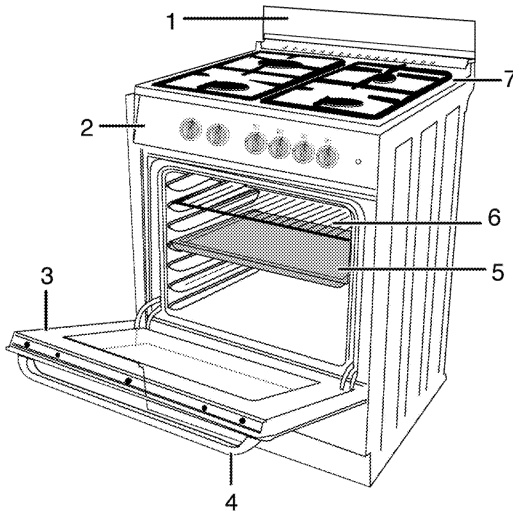

- |   |               |   |              |
|---|---------------|---|--------------|
| 1 | Splashback    | 5 | Tray         |
| 2 | Control panel | 6 | Wire shelf   |
| 3 | Front door    | 7 | Burner plate |
| 4 | Handle        |   |              |

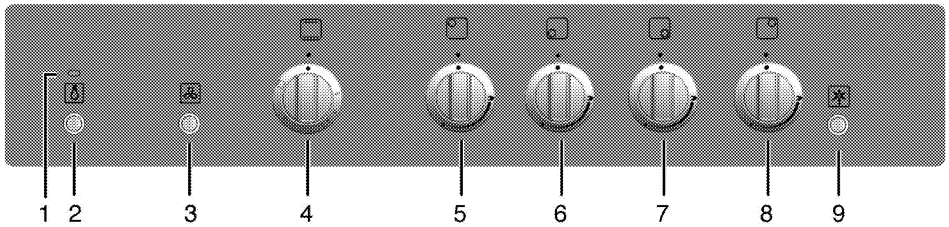

- |   |                              |
|---|------------------------------|
| 1 | Warning lamp                 |
| 2 | Lamp button                  |
| 3 | Fan button                   |
| 4 | Oven knob                    |
| 5 | Normal burner Rear left      |
| 6 | Wok burner Front left        |
| 7 | Auxiliary burner Front right |
| 8 | Normal burner Rear right     |
| 9 | Ignition button              |

## Package contents



Accessories supplied can vary depending on the product model. Not every accessory described in the user manual may exist on your product.

1. **User manual**

2. **Oven tray**

Used for pastries, frozen foods and big roasts.

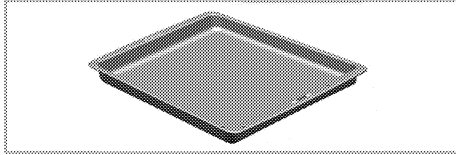

3. **Wire Shelf**

Used for roasting and for placing the food to be baked, roasted or cooked in casserole dishes to the desired rack.

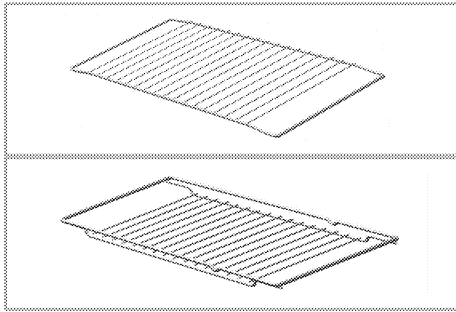

4. **Small wire shelf**

It is placed into the tray (if supplied) in order to collect the dripping fat while grilling so that the oven is kept clean.

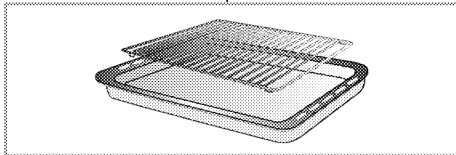

5. **Placing the wire shelf and tray onto the wire racks properly**

**Products without telescopic pull-out:** With product without a telescopic pull-out, the baking tray and grill are pushed in with their edges between the runners on the side mounts.

It is important to place the wire shelf and/or tray onto the rack properly. Slide the wire

shelf or tray between 2 rails and make sure that it is balanced before placing food on it (Please see the following figure).

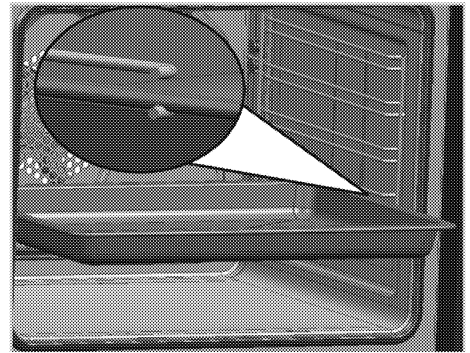
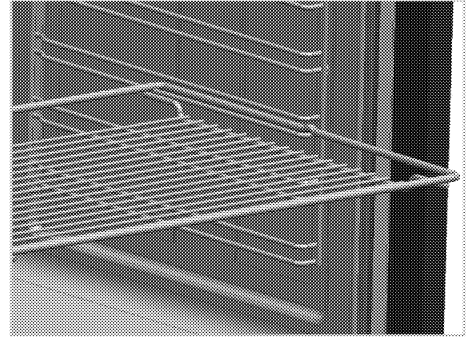

6. **Vok pan adaptor**

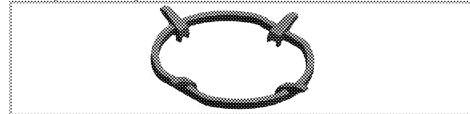

Used for hosting a wok pan with a round bottom.

## 7. Splash back assembly

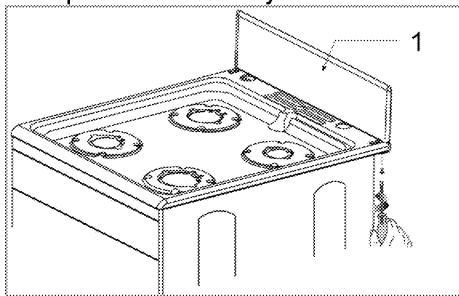

1 Splashback

Please take splashback and package of screws, nuts, fillers from warmer drawer  
Place splashback according to the drawing, place nut inside splashback on to the hole, screw the splashback to the burner's plate with screw from under burner plate

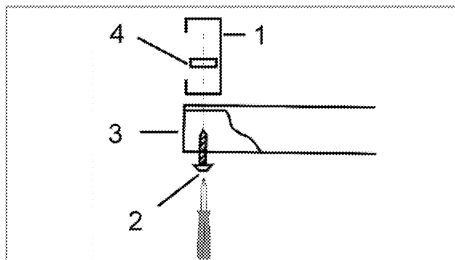

- 1 Splashback
- 2 Screw
- 3 Burner plate
- 4 Nut

If you don't want to install splashback on to your cooker, you can place fillers to the holes.

Do not overtighten the screws as damage to the hob or splashback could occur.

## Technical specifications

GENERAL	
External dimensions (height / width / depth)	900 mm/600 mm/600 mm
Voltage / frequency	230-240 V ~ 50 Hz
Total power consumption	2.4 kW
Fuse	min. 10 A
Cable type / section	H05VV-FG 3 x 1 mm <sup>2</sup>
Cable length	max. 2 m
Gas type / pressure	Natural gas 1.0 kPa
Total gas consumption	Natural gas 42.0 MJ/h Propane gas 42.4 MJ/h
Converting the gas type / pressure <sup>§</sup>	Propane gas 2.75 kPa
– optional	
HOB	
Burners	
Rear left	<b>Normal burner</b>
Power	7.5 MJ/h (NG) / 7.2 MJ/h (LPG)
Front left	<b>Wok burner</b>
Power	13.0 MJ/h (NG) / 12.1 MJ/h (LPG)
Front right	<b>Auxiliary burner</b>
Power	4.0 MJ/h (NG) / 3.4 MJ/h (LPG)
Rear right	<b>Normal burner</b>
Power	7.5 MJ/h (NG) / 7.2 MJ/h (LPG)
OVEN/GRILL	
Main oven	<b>Gas oven</b>
Inner lamp	15-25 W
Grill power consumption	2.2 kW
Gas consumption of oven	10.0 MJ/h (NG) / 12.5 MJ/h (LPG)



Technical specifications may be changed without prior notice to improve the quality of the product.



Figures in this manual are schematic and may not exactly match your product.



Values stated on the product labels or in the documentation accompanying it are obtained in laboratory conditions in accordance with relevant standards. Depending on operational and environmental conditions of the product, these values may vary.

## Injector table



Burner	Gas Type	Injector size (mm)	TPP (kPa)	NGC (MJ/h)
Small	Natural Gas	0,90	1,0	4,0
Medium (2)	Natural Gas	1,25	1,0	7,5
Wok	Natural Gas	1,60	1,0	13
Oven	Natural Gas	1,45	1,0	10
Small	Propane Gas	0,50	2,75	3,4
Medium (2)	Propane Gas	0,72	2,75	7,2
Wok	Propane Gas	0,92	2,75	12,1
Oven	Propane Gas	0,95	2,75	12,5

This cooker has been designed and constructed in accordance with the following codes and regulations:

- AS4551 - Approval requirements for Domestic Gas Cooking Appliances
- AS / NZS 3350-1 - General requirements for Domestic Electrical Appliances
- AS / NZS 3350-26 - Particular Requirements for Domestic Electrical Cooking Appliances
- AS / NZS 1044 - Electromagnetic Compatible Requirements.

### 3 Installation

Installation must be in accordance with this instruction manual, AS 5601.1 'gas installations' for installation and pipe sizing, local gas fitting regulations, municipal building codes, local electrical regulations and any other statutory regulation by an authorised person.  
NOT FOR USE IN MARINE CRAFT, CARAVANS OR MOBILE HOMES, unless each burner is fitted with a flame safeguard.

	Preparation of location and electrical and gas installation for the product is under customer's responsibility.
	<b>DANGER:</b> The product must be installed in accordance with all local gas and/or electrical regulations.
	<b>DANGER:</b> Prior to installation, visually check if the product has any defects on it. If so, do not have it installed. Damaged products cause risks for your safety.

#### Before installation

To ensure that critical air gaps are maintained under the appliance, we recommend that this appliance is mounted on a solid base and that the feet do not sink into any carpet or soft flooring.

The kitchen floor must be able to carry the weight of the appliance plus the additional weight of cookware and bakeware and food.

Installation clearances and protection of combustible surfaces shall comply with the (AS 5601) gas installations code. Installation shall comply with the dimension in figure bearing in mind that.

CLEARANCES from combustible materials

Overhead 750 mm

Rear wall 50 mm

Side walls 200 mm

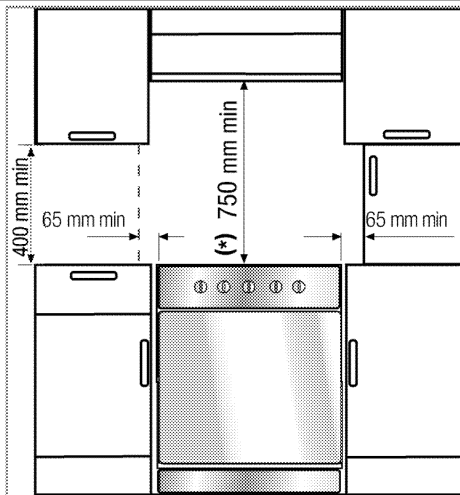

- It can be used with cabinets on either side but in order to have a minimum distance of 400mm above hotplate level allow a side clearance of 65mm between the appliance and any wall, partition or tall cupboard.
- It can also be used in a free standing position. Allow a minimum distance of 750 mm above the hob surface.
- (\*) If a cooker hood is to be installed above the cooker, refer to cooker hood manufacturer' instructions regarding installation height (min 650 mm).
- **Gas inlet:** Rear left hand side 150 mm from the top and 50 mm from the left towards the centre.
- **Electric inlet:** Rear left hand side 560mm from the top and 110 mm from the left towards the centre.
- The appliance corresponds to device class 1, i.e. it may be placed with the rear and **one** side to kitchen walls, kitchen furniture or equipment of any size. The kitchen furniture or equipment on the **other** side may only be of the same size or smaller.
- Any kitchen furniture next to the appliance must be heat-resistant (100 °C min.).

## Safety chain

The appliance must be secured against overbalancing by using the supplied two safety chains on your oven.

Fasten hook (1) by using a proper peg to the kitchen wall (6) and connect safety chain (3) to the hook via the locking mechanism (2).

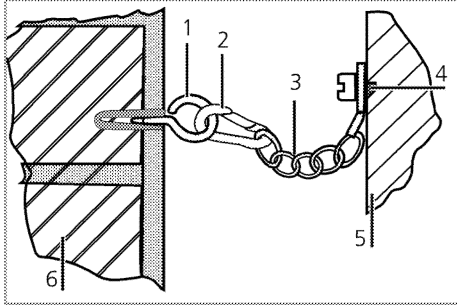

- 1 Stability hook
- 2 Locking mechanism
- 3 Safety chain (supplied and mounted to oven)
- 4 Firmly fix chain to cooker rear
- 5 Rear of cooker
- 6 Kitchen wall



Stability chain to be as short as practicable to avoid oven tilting forward and diagonal to avoid oven side tilting.

Cooker stability chain for cookers not designed with bracket engagement slot.

## Room ventilation

All rooms require an openable window, or equivalent, and some rooms will require a permanent vent as well.

The air for combustion is taken from the room air and the exhaust gases are emitted directly into the room.

Good room ventilation is essential for safe operation of your appliance. If there is no window or door available for room ventilation, an extra ventilation must be installed.

The appliance may be located in a kitchen, kitchen/diner or a bed-sitting room, but not in a room containing a bath or shower. The appliance must not be installed in a bed-sitting room of less than 20m<sup>3</sup>.

Do not install this appliance in a room below ground level unless it is open to ground level on at least one side.

Room size	Ventilation opening
smaller than 5 m <sup>3</sup>	min. 100 cm <sup>2</sup>
5 m <sup>3</sup> to 10 m <sup>3</sup>	min. 50 cm <sup>2</sup>
greater than 10 m <sup>3</sup> /den	not required
In the cellar or basement	min. 65 cm <sup>2</sup>

## Installation and connection

Product can only be installed and connected in accordance with the statutory installation rules.



Do not install the product next to refrigerators or freezers. The heat emitted by the product will increase the energy consumption of cooling appliances.

- Carry the product with at least two persons.
- Product must be placed directly on the floor. It must not be placed onto a base or a pedestal.



Do not use the door and/or handle to carry or move the product. The door, handle or hinges get damaged.

## Electrical connection

Connect the product to a grounded outlet/line protected by a fuse of suitable capacity as stated in the "Technical specifications" table. Have the grounding installation made by a qualified electrician while using the product with or without a transformer. Our company shall not be liable for any damages that will arise due to using the product without a grounding installation in accordance with the local regulations.



### DANGER:

The product must be connected to the mains supply only by an authorised and qualified person. The product's warranty period starts only after correct installation.

Manufacturer shall not be held responsible for damages arising from procedures carried out by unauthorised persons.

**DANGER:**

The power cable must not be clamped, bent or trapped or come into contact with hot parts of the product.  
A damaged power cable must be replaced by a qualified electrician. Otherwise, there is risk of electric shock, short circuit or fire!

The mains supply data must correspond to the data specified on the type label of the product. The rating plate is either seen when the door or the lower cover is opened or it is located at the rear wall of the unit depending on the unit type. Power cable of your product must comply with the values in "Technical specifications" table.



Power cable plug must be within easy reach after installation (do not route it above the hob).

**DANGER:**

Before starting any work on the electrical installation, disconnect the product from the mains supply. There is the risk of electric shock!

Plug the power cable into the socket.

**Gas connection****DANGER:**

Product can be connected to gas supply system only by an authorised and qualified person.  
Risk of explosion or toxication due to unprofessional repairs!  
Manufacturer shall not be held responsible for damages arising from procedures carried out by unauthorised persons.

**DANGER:**

Before starting any work on the gas installation, disconnect the gas supply. There is the risk of explosion!

- Gas adjustment conditions and values are stated on labels (or ion type label).
- This product is suitable for connection with an AGA approved hose assembly.

**Suitable for Flexible Hose Connection**

Connection hose must comply to **AS1869 class B** 10mm diameter & be **AGA** certified length of hose is to be as short as possible hose length must not exceed 1.2m the hose must not be kinked or be able to touch any hot surface when installed.

**Gas connection for Natural Gas- 1.0 kPa**

Your product is equipped for natural gas (NG).

Appliance should be connected using an isolation valve, union and regulator.

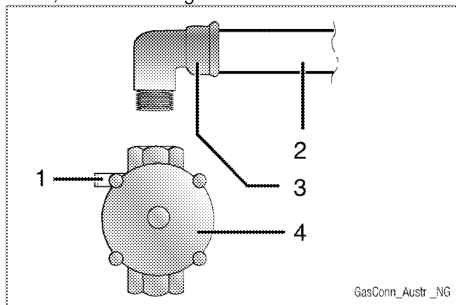

- 1 Test point
- 2 Gas regulator
- 3 Elbow
- 4 Gas inlet pipe

**Connecting with hose assembly**

Where a hose assembly is to be used for the gas connection to this appliance it must :

- Comply to AS1869 Class B 10 mm diameter, be AGA gas.
- Be a short as possible, but in no case longer than 1.2 m.
- This appliance is suitable for installation with a hose assembly.
- The hose must not be able to touch any hot surface or be kinked when appliance is installed.
- At the completion of the installation, test for leaks.



Do not use Naked Flame to test for leaks.





To ensure correct operation of the appliance it is necessary to set the correct pressure for the appliance **1.0kPa for Natural Gas** and **2.75 kPa for LPG (Propane)**.

Check the pressure by connecting the pressure gauge or manometer to test point as shown on adjacent figures. Set pressure with 2-3 burners operating on high.

Check for correct operation of burners, ignition system etc and demonstrate operation of appliance to customer.

If burner low setting requires adjustment refer to conversion procedure for adjustment.

 **DANGER:**  
Do not use open flame or do not smoke.  
Do not operate any electrical buttons (e.g. lamp button, door bell and etc.)  
Do not use fixed or mobile phones.  
Risk of explosion and toxication!

 **DANGER:**  
The gas hose must not be clamped, bent or trapped or come into contact with hot parts of the product.  
There is the risk of explosion due to damaged gas hose.

- Push the product towards the kitchen wall.
- **Adjusting the feet of oven**  
Vibrations during use may cause cooking vessels to move. This dangerous situation can be avoided if the product is level and balanced.  
For your own safety please ensure the product is level by adjusting the four feet at the bottom by turning left or right and align level with the work top.

### Final check

1. Check electrical functions.
2. Open gas supply.
3. Check gas installations for secure fitting and tightness.
4. Ignite burners and check appearance of the flame.

 Flame must be blue and have a regular shape. If the flame is yellowish, check if the burner cap is seated securely or clean the burner.

### Gas conversion

 **DANGER:**  
Before starting any work on the gas installation, disconnect the gas supply.  
There is the risk of explosion!

In order to change your appliance's gas type, change all injectors and make flame adjustment for all valves at reduced flow rate position.

### Exchange of injector for the burners

1. Take off burner cap and burner body.
2. Unscrew injectors by turning the counter-clockwise.
3. Fit new injectors.
4. Check all connections for secure fitting and tightness.

 New injectors have their position marked on their packing or injector table on *Injector table, page 13* can be referred to.

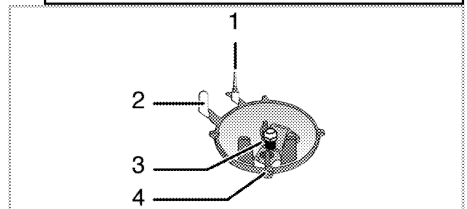

- 1 Flame failure device (model dependant)
- 2 Spark plug
- 3 Injector
- 4 Burner

 Unless there is an abnormal condition, do not attempt to remove the gas burner taps.  
You must call an Authorised service agent if it is necessary to change the taps.

### Reduced gas flow rate setting for hob taps

1. Ignite the burner that is to be adjusted and turn the knob to the reduced position.
2. Remove the knob from the gas tap.
3. Use an appropriately sized screwdriver to adjust the flow rate adjustment screw.

For LPG (Butane - Propane) turn the screw clockwise. For the natural gas, you should turn the screw **counter-clockwise** once.

» The normal length of a straight flame in the reduced position should be 6-7 mm.

4. If the flame is higher than the desired position, turn the screw clockwise. If it is smaller turn anticlockwise.
5. For the last control, bring the burner both to high-flame and reduced positions and check whether the flame is on or off.

Depending on the type of gas tap used in your appliance the adjustment screw position may vary.

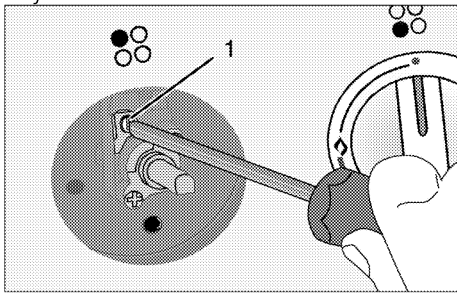

1 Flow rate adjustment screw

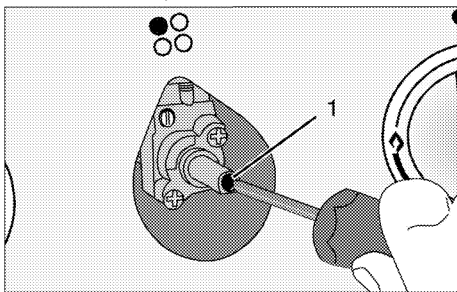

1 Flow rate adjustment screw

### Exchange of injector for the oven

1. Unscrew fastening screws of the back wall.

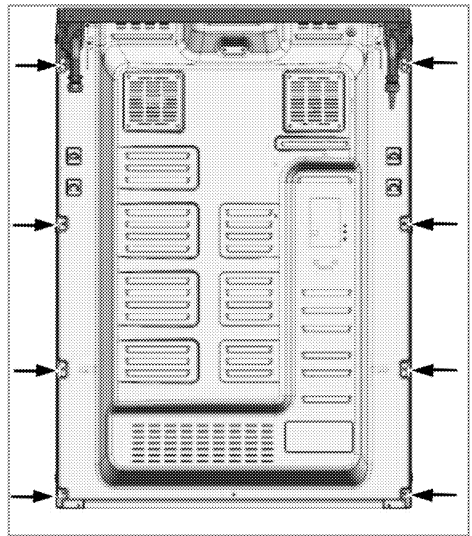

2. Unscrew the 2 screws (2) of the injector holder (1).

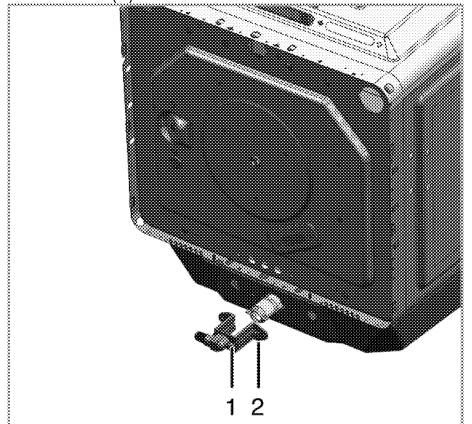

- 1 Injector holder
- 2 Screw
3. Pull out the injector holder.
4. Unscrew injector by turning to counter-clockwise direction.
5. Fit new injector.

### Reduced flow adjustment for the gas oven

For the appropriate functioning of the oven re-checking the by-pass adjustment is extremely important. In order to provide maximum security to the user these operations have to be done with care.

1. Ignite the burner that is to be adjusted and turn the knob to the high flame position.
2. Close the oven door and wait for 10 to 15 minutes until the oven becomes ready for adjustment.
3. Take out the knob
4. After 15 minutes, adjust the oven to the lowest flame position.

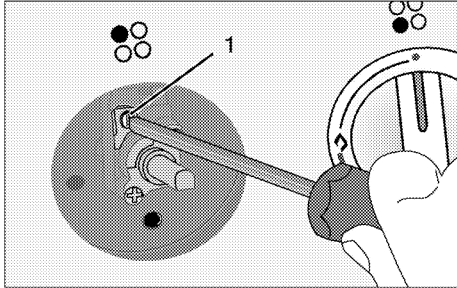

5. Set the flame length to 2 to 3 mm by means of the screw 1 on the oven tap. Turning in clockwise direction reduces the flame, turning counter-clockwise increases the flame.

**i** If the temperature of the oven increases unintentionally, turn off the oven and call the authorised service agent to have oven thermostat repaired.

**i** If the gas type of the unit is changed, then the rating plate that shows the gas type of the unit must also be changed.

### Future Transportation

- Keep the product's original carton and transport the product in it. Follow the instructions on the carton. If you do not have the original carton, pack the product in bubble wrap or thick cardboard and tape it securely.
- To prevent the wire grill and tray inside the oven from damaging the oven door, place a strip of cardboard onto the inside of the oven door that lines up with the position of the trays. Tape the oven door to the side walls.
- Secure the caps and pan supports with adhesive tape.
- Do not use the door or handle to lift or move the product.

**i** Do not place any objects onto the product and move it in upright position.

**i** Check the general appearance of your product for any damages that might have occurred during transportation.

Butan/propan	Natural gas
Fasten the screw until the end	Loosen the screw 1/2 round



## 4 Preparation

### Tips for saving energy

The following information will help you to use your appliance in an ecological way, and to save energy:

- Use dark coloured or enamel coated cookware in the oven since the heat transmission will be better.
- While cooking your dishes, perform a preheating operation if it is advised in the user manual or cooking instructions.
- Do not open the door of the oven frequently during cooking.
- Try to cook more than one dish in the oven at the same time whenever possible. You can cook by placing two cooking vessels onto the wire shelf.
- Cook more than one dish one after another. The oven will already be hot.
- Defrost frozen dishes before cooking them.
- Use pots/pans with cover for cooking. If there is no cover, energy consumption may increase 4 times.
- Select the burner which is suitable for the bottom size of the pot to be used. Always select the correct pot size for your dishes. Larger pots require more energy.

### Initial use

#### First cleaning of the appliance



The surface might get damaged by some detergents or cleaning materials.

Do not use aggressive detergents, cleaning powders/creams or any sharp objects during cleaning.

Do not use harsh abrasive cleaners or sharp metal scrapers to clean the oven door glass since they can scratch the surface, which may result in shattering of the glass.

1. Remove all packaging materials.

2. Wipe the surfaces of the appliance with a damp cloth or sponge and dry with a cloth.

#### Initial heating

Heat up the product for about 30 minutes and then switch it off. Thus, any production residues or layers will be burnt off and removed.



#### WARNING

Hot surfaces cause burns!

Product may be hot when it is in use. Never touch the hot burners, inner sections of the oven, heaters and etc. Keep children away. Always use heat resistant oven gloves when putting in or removing dishes into/from the hot oven.

#### Gas oven

1. Take all baking trays and the wire grill out of the oven.
2. Close the oven door.
3. Select the highest flame of the gas oven; see *How to use the gas oven, page 23*.
4. Operate the oven about 30 minutes.
5. Turn off your oven; See *How to use the gas oven, page 23*

#### Grill oven

1. Take all baking trays and the wire grill out of the oven.
2. Close the oven door.
3. Select the highest grill power; see *How to operate the grill, page 25*.
4. Operate the grill about 30 minutes.
5. Turn off your grill; see *How to operate the grill, page 25*



Smoke and smell may emit for a couple of hours during the initial operation. This is quite normal. Ensure that the room is well ventilated to remove the smoke and smell. Avoid directly inhaling the smoke and the smell that emits.

## 5 How to use the hob

### General information about cooking



Never fill the pan with oil more than one third of it. Do not leave the hob unattended when heating oil. Overheated oils bring risk of fire. **Never attempt to extinguish a possible fire with water!** When oil catches fire, cover it with a fire blanket or damp cloth. Turn off the hob if it is safe to do so and call the fire department.

- Before frying foods, always dry them well and gently place into the hot oil. Ensure complete thawing of frozen foods before frying.
- Do not cover the vessel you use when heating oil.
- Place the pans and saucepans in a manner so that their handles are not over the hob to prevent heating of the handles. Do not place unbalanced and easily tilting vessels on the hob.
- Do not place empty vessels and saucepans on cooking zones that are switched on. They might get damaged.
- Operating a cooking zone without a vessel or saucepan on it will cause damage to the product. Turn off the cooking zones after the cooking is complete.
- As the surface of the product can be hot, do not put plastic and aluminum vessels on it. Such vessels should not be used to keep foods either.
- Use flat bottomed saucepans or vessels only.
- Put appropriate amount of food in saucepans and pans. Thus, you will not have to make any unnecessary cleaning by preventing the dishes from overflowing. Do not put covers of saucepans or pans on cooking zones.  
Place the saucepans in a manner so that they are centered on the cooking zone.  
When you want to move the saucepan onto another cooking zone, lift and place it onto

the cooking zone you want instead of sliding it.

### Gas cooking

- Size of the vessel and the flame must match each other. Adjust the gas flames so that they will not extend the bottom of the vessel and center the vessel on saucepan carrier.

### Using the hobs

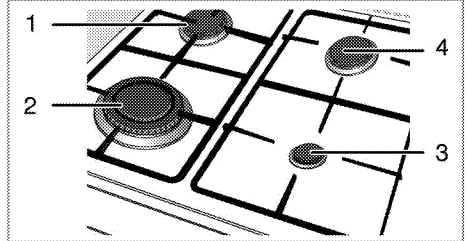

- 1 Normal burner 18-20 cm
- 2 Wok burner 22-24 cm
- 3 Auxiliary burner 12-18 cm
- 4 Normal burner 18-20 cm is list of advised diameter of pots to be used on related burners.

Large flame symbol indicates the highest cooking power and small flame symbol indicates the lowest cooking symbol. In turned off position (top), gas is not supplied to the burners.

### Igniting the gas burners



Gas burners are ignited with ignition buttons.

1. Keep burner knob pressed.
2. Turn it counter clockwise to large flame symbol.
3. Press and release the ignition button. Repeat the procedure until the released gas is ignited.
4. Adjust it to the desired cooking power.

### Turning off the gas burners

Turn the keep warm zone knob to off (upper) position.

## Gas shut off safety system (in models with thermic component)

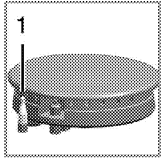

1. Gas shut off safety

As a counter measure against blow out due to fluid overflows at burners, safety mechanism trips and shuts off the gas.

- Push the knob inwards and turn it counter clockwise to ignite.
- After the gas ignites, keep the knob pressed for 3-5 seconds more to engage the safety system.
- If the gas does not ignite after you press and release the knob, repeat the same procedure by keeping the knob pressed for 15 seconds.



### **DANGER:**

Release the button if the burner is not ignited within 15 seconds.  
Wait at least 1 minute before trying again.  
There is the risk of gas accumulation and explosion!

## Wok burner

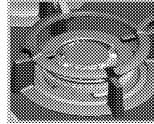

Wok burners help you to cook faster. Wok, which is particularly used in Asian kitchen is a kind of deep and flat fry-pan made of sheet metal, which is used to cook minced vegetable and meat at strong flame in a short time.

Since meals are cooked at strong flame and in a very short time in such fry-pans that conduct the heat rapidly and evenly, the nutrition value of the food is preserved and vegetables remain crispy. You can use wok burner for regular saucepans as well.

If you want to use regular saucepan on wok burner, you must take out the wok fry-pan carrier from the hob.

## 6 How to operate the oven

### General information on baking, roasting and grilling



#### WARNING

Hot surfaces cause burns!

Product may be hot when it is in use. Never touch the hot burners, inner sections of the oven, heaters and etc. Keep children away. Always use heat resistant oven gloves when putting in or removing dishes into/from the hot oven.



#### DANGER:

Be careful when opening the oven door as steam may escape. Exiting steam can scald your hands, face and/or eyes.

#### Tips for baking

- Use non-sticky coated appropriate metal plates or aluminum vessels or heat-resistant silicone moulds.
- Make best use of the space on the rack.
- Place the baking mould in the middle of the shelf.
- Select the correct rack position before turning the oven or grill on. Do not change the rack position when the oven is hot.
- Keep the oven door closed.

#### Tips for roasting

- Treating whole chicken, turkey and large piece of meat with dressings such as lemon juice and black pepper before cooking will increase the cooking performance.
- It takes about 15 to 30 minutes longer to roast meat with bones when compared to roasting the same size of meat without bones.
- Each centimeter of meat thickness requires approximately 4 to 5 minutes of cooking time.
- Let meat rest in the oven for about 10 minutes after the cooking time is over. The juice is better distributed all over the roast and does not run out when the meat is cut.

- Fish should be placed on the middle or lower rack in a heat-resistant plate.

#### Tips for grilling

When meat, fish and poultry are grilled, they quickly get brown, have a nice crust and do not get dry. Flat pieces, meat skewers and sausages are particularly suited for grilling as are vegetables with high water content such as tomatoes and onions.

- Distribute the pieces to be grilled on the wire shelf or in the baking tray with wire shelf in such a way that the space covered does not exceed the size of the heater.
- Slide the wire shelf or baking tray with grill into the desired level in the oven. If you are grilling on the wire shelf, slide the baking tray to the lower rack to collect fats. Add some water in the tray for easy cleaning.



Foods that are not suitable for grilling carry the risk of fire. Only grill food which is suitable for intensive grilling heat.

Do not place the food too far in the back of the grill. This is the hottest area and fatty food may catch fire.

### How to use the gas oven

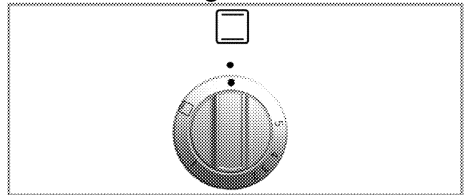

The gas oven is operated by the gas oven control knob. In off position (top) the gas supply is Off.



**If you turn on fan** while using gas oven, you can get more homogeneous cooking.



Before lighting the oven, open the oven door.

## Switch on the gas oven

The gas oven is ignited with the ignition button.

1. Open oven door.
  2. Keep gas oven control knob pressed and turn it **counterclockwise**.
  3. Press ignition button and release it again.
  4. Keep the gas oven control knob pressed for 3 to 5 seconds.
- » Repeat the process until the emanating gas is ignited.
5. Keep the gas oven control knob pressed for another 3 to 5 seconds. Be sure that gas has ignited and flame is present.
  6. Select the desired baking power/ gas mark.
  7. If there is no electricity; ignite the gas with the gas lighter from the ignition control hole.



## DANGER:

There is the risk of gas compression and explosion!  
Do not attempt to ignite the gas more than 15 seconds. If the burner is not ignited within 15 seconds, turn off the knob and wait for 1 minute. Ventilate the room before reattempting to ignite the burner. There is the risk of gas compression and explosion!

## Switch off the gas oven

1. Turn gas oven control knob to off position (top).

Gas level temperature chart

Gas level	1	2	3	4	5
Temperature in °C	170	180	200	230	280

## Cooking times table



1st rack of the oven is the **bottom** rack.



Maximum load capacity of oven tray: 4 kg (8.8 lb).



The timings in this chart are meant as a guide. Timings may vary due to temperature of food, thickness, type and your own preference of cooking.

Stand dishes on a baking sheet to prevent spillages onto oven base and help keep oven clean.

## Baking and roasting

Food	Preheating *	Insertion level	Control knob position	Cooking time
Apple pie	10 min.	3	1	60...70 min.
Fruit tart	10 min.	3	1	60...70 min.
Pie	10 min.	3	1	60...70 min.
Cookies	10 min.	4	1..2	30...40 min.
Pastry	10 min.	3..4	1..2	40...50 min.
Cake	10 min.	3	1..2	60...70 min.
Biscuits	10 min.	4	1..2	30...40 min.
Roast lamb	10 min.	4..5	3	35...45 min. per 450 g + 30 min.
Roast Beef	10 min.	3..4	3	100...130 min. per 450 g + 30 min.
Turkey	10 min.	3	3	100...130 min. per 450 g + 30 min.
Poultry	10 min.	3	1..2	100...130 min. per 450 g + 25 min. <sup>S</sup>
Casseroles	10 min.	4	1..2	90...120 min. <sup>S</sup>
Fish	10 min.	3	1..2	45...55 min.
Macaroni	10 min.	4	1..2	50...55 min.
Small cakes	10 min.	3..4	1	40...50 min.
Victoria sandwich	10 min.	3	1	30...35 min.

\* at control knob position 5 / <sup>S</sup> depending on quantity / <sup>#</sup> depending on size



## How to operate the grill



### WARNING

Close oven door during grilling.  
Hot surfaces may cause burns!

### Switching on the grill

1. Turn the Function knob clockwise to the Grill symbol.
2. If required, perform a preheating of about 5 minutes.

» Temperature light turns on.



Do not attempt to turn the Function knob **clockwise** to set it to the Off (upper) position.

### Switching off the grill

1. Turn the Function knob **counterclockwise** to Off (upper) position to turn off the oven.

### Rack positions

Grill performance will decrease if the wire grill stands against rear part of the oven. Slide your wire grill to the front section of the rack and settle it with the help of the door in order to obtain the best grill performance.

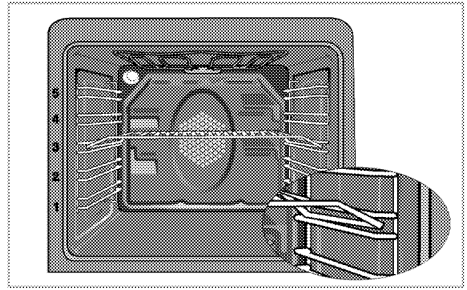

### IMPORTANT WARNING WHEN GRILLING

Your freestanding cooker is fitted with an electric grill element which is designed to grill all types of food, many of which can be grilled on the highest shelf position.

**When grilling food with HIGH FAT content** such as pork and fatty chops it is advised that position 4 or 3 be utilised for these types of food to reduce the amount of spatter created during grilling. Too much spatter coming in contact with the grill element will create a lot of smoke but also the risk of flare ups may be created.



Foods that are not suitable for grilling carry the risk of fire. Only grill food which is suitable for intensive grilling heat.

Do not place the food too far in the back of the grill. This is the hottest area and fatty food may catch fire.

## Cooking times table for grilling

### Grilling with electric grill

Food	Insertion level	Grilling time (approx.)
Fish	4..5	20...25 min. #
Sliced chicken	4..5	25...35 min.
Lamb chops	4..5	20...25 min.
Roast beef	4..5	25...30 min. #
Veal chops	4..5	25...30 min. #
Toast bread	4	1...2 min.

# depending on thickness

## 7 Maintenance and care

### General information

Service life of the product will extend and the possibility of problems will decrease if the product is cleaned at regular intervals.



#### DANGER:

Disconnect the product from mains supply before starting maintenance and cleaning works.

There is the risk of electric shock!



#### DANGER:

Allow the product to cool down before you clean it.

Hot surfaces may cause burns!

- Clean the product thoroughly after each use. In this way it will be possible to remove cooking residues more easily, thus avoiding these from burning the next time the appliance is used.
- No special cleaning agents are required for cleaning the product. Use warm water with washing liquid, a soft cloth or sponge to clean the product and wipe it with a dry cloth.
- Always ensure any excess liquid is thoroughly wiped off after cleaning and any spillage is immediately wiped dry.
- Do not use cleaning agents that contain acid or chloride to clean the stainless or inox surfaces and the handle. Use a soft cloth with a liquid detergent (not abrasive) to wipe those parts clean, paying attention to sweep in one direction.



The surface might get damaged by some detergents or cleaning materials.

Do not use aggressive detergents, cleaning powders/creams or any sharp objects during cleaning.

Do not use harsh abrasive cleaners or sharp metal scrapers to clean the oven door glass since they can scratch the surface, which may result in shattering of the glass.



Do not use steam cleaners to clean the appliance as this may cause an electric shock.

### Cleaning the hob

#### Gas hobs

1. Remove and clean the saucepan carriers and burner caps.
2. Clean the hob.
3. Install the burner caps and make sure that they are seated correctly.
4. When installing the upper grills, pay attention to place the saucepan carriers so that the burners are centered.

### Cleaning the control panel

Clean the control panel and knobs with a damp cloth and wipe them dry.



Do not remove the control buttons/knobs to clean the control panel.

Control panel may get damaged!

### Cleaning the oven

#### To clean the side wall

1. Remove the front section of the side rack by pulling it in the opposite direction of the side wall.
2. Remove the side rack completely by pulling it towards you.

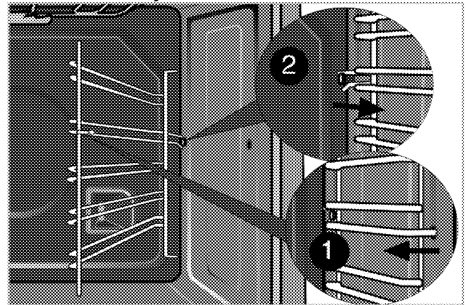

#### Catalytic walls

Side walls or just back wall of oven interior may be covered with catalytic enamel.

The catalytic walls of the oven must not be cleaned. The porous surface of the walls is self-cleaning by absorbing and converting spitting fat (steam and carbon dioxide).

## Clean oven door

To clean the oven door, use warm water with washing liquid, a soft cloth or sponge to clean the product and wipe it with a dry cloth.



Don't use any harsh abrasive cleaners or sharp metal scrapers for cleaning the oven door. They could scratch the surface and destroy the glass.

## Removing the oven door

1. Open the front door (1).
2. Open the clips at the hinge housing (2) on the right and left hand sides of the front door by pressing them down as illustrated in the figure.

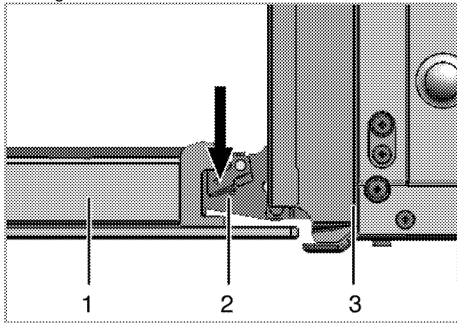

- 1 Front door
- 2 Hinge
- 3 Oven

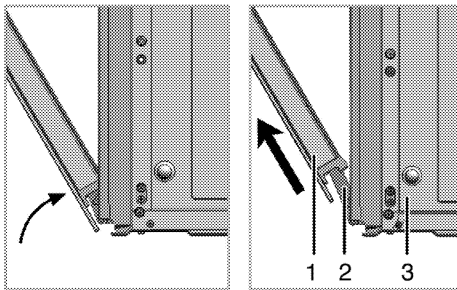

3. Move the front door to half-way.
4. Remove the front door by pulling it upwards to release it from the right and left hinges.



Steps carried out during removing process should be performed in reverse order to install the door. Do not forget to close the clips at the hinge housing when reinstalling the door.

## Replacing the oven lamp



### DANGER:

Before replacing the oven lamp, make sure that the product is disconnected from mains and cooled down in order to avoid the risk of an electrical shock. Hot surfaces may cause burns!



The oven lamp is a special electric light bulb that can resist up to 300 °C. See *Technical specifications, page 12* for details. Oven lamps can be obtained from Authorised Service Agents.



Position of lamp might vary from the figure.

## If your oven is equipped with a round lamp:

1. Disconnect the product from mains.
2. Turn the glass cover counter clockwise to remove it.

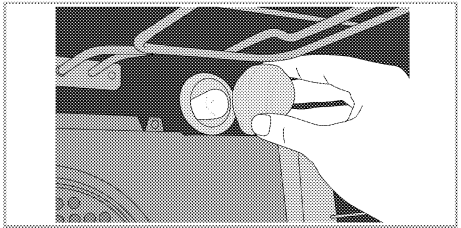

3. Remove the oven lamp by turning it counter clockwise and replace it with the new one.
4. Install the glass cover.

## 8 Troubleshooting

### Oven emits steam when it is in use.

- It is normal that steam escapes during operation. >>> *This is not a fault.*

### Product emits metal noises while heating and cooling.

- When the metal parts are heated, they may expand and cause noise. >>> *This is not a fault.*

### Product does not operate.

- The mains fuse is defective or has tripped. >>> *Check fuses in the fuse box. If necessary, replace or reset them.*
- Product is not plugged into the (grounded) socket. >>> *Check the plug connection.*

### There is no ignition spark.

- No current. >>> *Check fuses in the fuse box.*

### There is no gas.

- Main gas valve is closed. >>> *Open gas valve.*
- Gas pipe is bent. >>> *Install gas pipe properly.*

### Burners are not burning properly or at all.

- Burners are dirty. >>> *Clean burner components.*
- Burners are wet. >>> *Dry the burner components.*
- Burner cap is not mounted safely. >>> *Mount the burner cap properly.*
- Gas valve is closed. >>> *Open gas valve.*
- Gas cylinder is empty (when using LPG). >>> *Replace gas cylinder.*



Consult the Authorised Service Agent or the dealer where you have purchased the product if you can not remedy the trouble although you have implemented the instructions in this section. Never attempt to repair a defective product yourself.







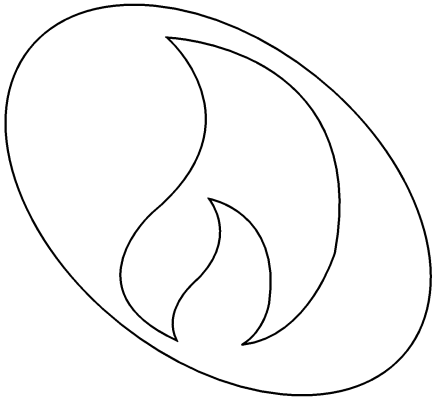

EAN kodu yapıştırma yeri

### Data Label

Tip etiketi yapıştırma yeri

Printed in Turkey

Part no. 285.3014.27

Revision no. R.AA - 29.05.2013