



SMART TV Quick Setup Guide



* Image shown may differ from your TV.
 * Image shown on a PC or mobile phone may vary depending on the Operating System (OS).
 * App icon positions may vary on the platform, depending on the software version.

Wireless Network Connection

* Applicable for wi-fi ready models only.



or

* Applicable for wi-fi models only.



Wired Network Connection

* For a stable Internet connection, it is recommended to use a wired connection or place the wireless router close to the TV.

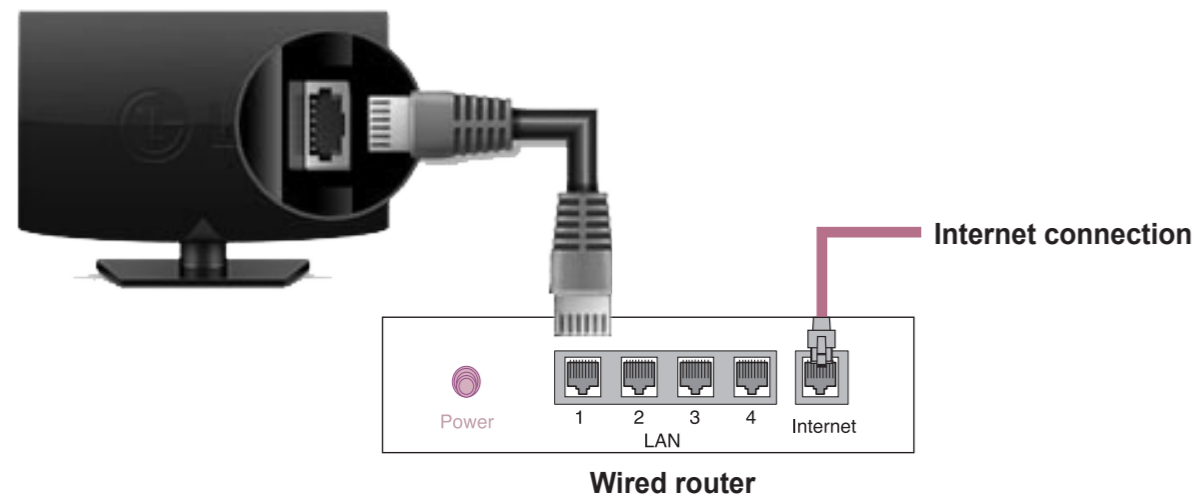

P/NO : MBM63817872 (1405-REV02)
 Printed in Korea

Network Settings

1 Press the **Home** button on the remote to access the Home menu. Highlight the **(Settings)** icon and select by pressing the **Wheel(OK)** button on the remote.

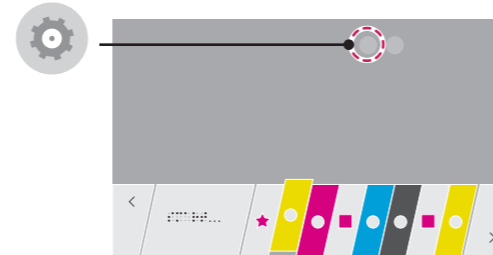

2 Select the **Network** → **Wired Connection** or **Wi-Fi Connection**.



3 The device automatically tries to connect to the network available (wired network first). When you select the **Wi-Fi Connection**, the network list available is displayed. Choose the network you wish to use.

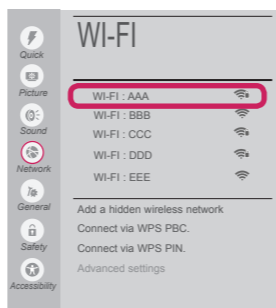

For wireless AP (Router) that have the symbol, you need to enter the security key.

4 If the connection is successful, the **"Connected to Internet"** network is displayed.

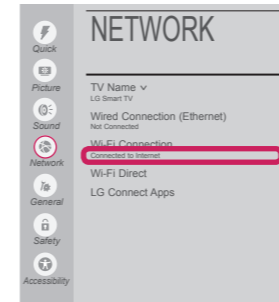

You can check the status of connection in **Advanced Settings**.

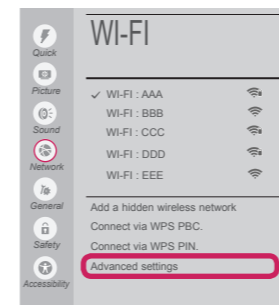

Troubleshooting Network Problems

1 Press the **Home** button on the remote to access the Home menu. Highlight the **(Settings)** icon and select by pressing the **Wheel(OK)** button on the remote.

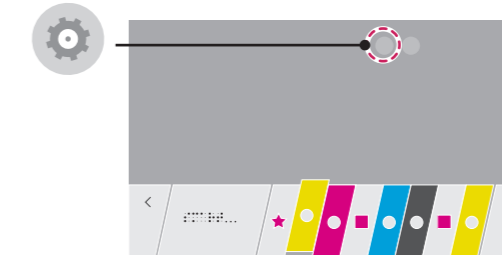

2 Select the **Network** → **Wired Connection** or **Wi-Fi Connection** → **Advanced Settings**.

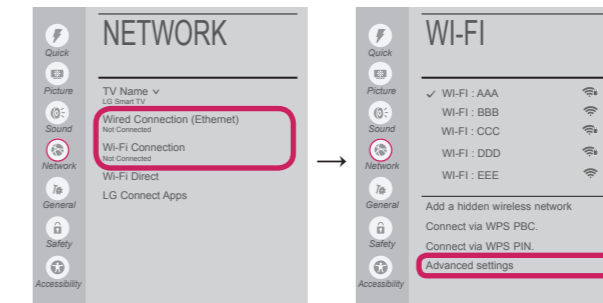

Follow the instructions below that correlate to your network status.

Check the TV or the AP (Router).



When X appears next to TV:

- 1 Check the connection status of the TV, AP (Router).
- 2 Power off and power on the TV, AP (Router).
- 3 If you are using a static IP, enter the IP directly.
- 4 Contact internet service provider or AP (Router) company.

Check the AP (Router) or consult your Internet service provider.



When X appears next to Gateway:

- 1 Unplug the power cord of the AP (Router) and try to connect after 5 seconds.
- 2 Initialize (Reset) the AP (Router).
- 3 Contact internet service provider or AP (Router) company.



When X appears next to DNS:

- 1 Unplug the power cord of the AP (Router) and try to connect after 5 seconds.
- 2 Initialize (Reset) the AP (Router).
- 3 Check that the MAC address of the TV/AP (Router) is registered with your Internet service provider. (The MAC address displayed on the right pane of the network status window should be registered with your Internet service provider.)
- 4 Check the AP (Router) manufacturer's website to make sure your router has the latest firmware version installed.

When X appears next to TV:

- 1 Check the connection status of the TV, AP (Router).
- 2 Power off and power on the TV, AP (Router).
- 3 If you are using a static IP, enter the IP directly.
- 4 Contact internet service provider or AP (Router) company.

Please call LG Customer Service if you experience any problems.



SMART TV Quick Setup Guide

SmartShare PC SW Installing & Setting

- 1 Install the **SmartShare PC SW** program on your PC.
- 2 Go to www.lg.com. Then, select your region.
- 3 Select **SUPPORT**. Then, search for your model.
- 4 Select **Drivers & Software** or **SOFTWARE UPDATE**. Then, select **SmartShare PC SW**.
- 5 You can run the program when installation is complete.

NOTE

- **SmartShare** service is only available if TV and other devices are connected via a single AP (Router).

SmartShare Connection to Smartphone



- 1 Check that Wi-Fi is enabled on your smartphone. To use **SmartShare**, both devices must be on the same local network.
- 2 Install/run the app for sharing content on your smartphone (It's called **SmartShare** on LG phones).
- 3 Enable your smartphone to share content files with other devices.
- 4 Open **SmartShare** application. **(Home) → SmartShare**.
- 5 Select the file type you want to play (movie, audio or photo).
- 6 Select a movie, music or photo file to play on the TV.
- 7 Play the media file to view and enjoy it on your TV.

Updating the TV Firmware

* If the TV is turned on for the first time after software update, initialization of the TV may take up to one minute.

(Home) → (Settings) → General → About This TV → CHECK FOR UPDATES

After checking the version of the software, update it.
If you check the **"Allow Automatic Updates"**, you can update the software automatically.

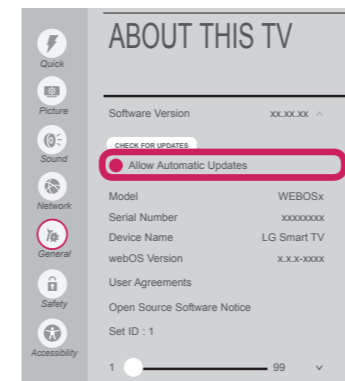
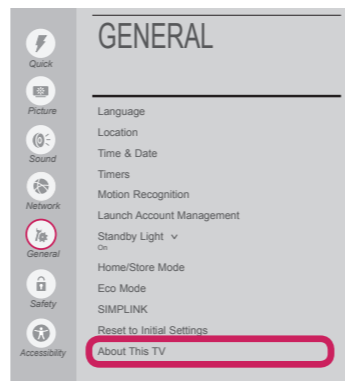

Wi-Fi Direct Setting

(Home) → (Settings) → Network → Wi-Fi Direct

If a local network is not available, you can connect a portable device directly to the TV using Wi-Fi Direct. With **SmartShare**, you can share files or screens of devices connected to **Wi-Fi Direct**.

- 1 If **Wi-Fi Direct** is set to **ON**, a list of available devices appears.



- 2 When you are prompted to request connection, select **Yes**. **Wi-Fi Direct** is now connected to your TV.

* If you are not using **Wi-Fi Direct** to minimize the interference between Wi-Fi devices, it is recommended to set **Wi-Fi Direct** to **Off**. You can only use devices that support Wi-Fi Direct.

Miracast Setting



Miracast allows a portable device to securely send video and sound to the TV wirelessly.

(Home) → Screen Share

- 1 **Miracast** should be set to **"ON"** on your portable device.
- 2 When your TV is detected, select the device on your portable device. When connection is completed, the TV screen appears on the device screen.

WiDi (Wireless Display) Setting

Intel's WiDi (Wireless Display) technology enables easy and fast connection without wires or internet network for mirrored and dual monitor display on your TV. You can sit back and experience your favorite movies, videos, photos, online shows and more in full HD on your TV with great image clarity and sound.

(Home) → Screen Share

- 1 **Intel's WiDi** is set to **On**. Connect your laptop to AP (Router). (Without AP, it is possible to use this function; it is recommended to connect to AP.) Your laptop runs the Intel WiDi program.
- 2 It detects LG Smart TVs available, which supports WiDi. In the list, select the TV you want and click Connect. Enter the number shown on the screen into the input field (a) on your laptop and then click Continue.

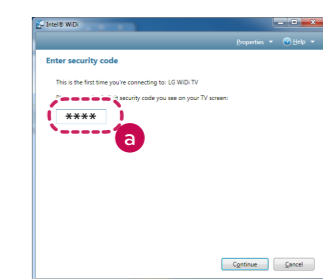
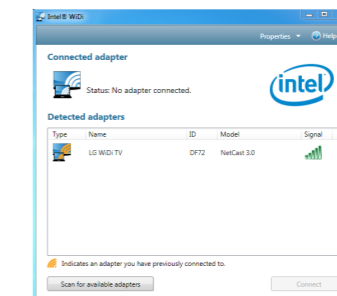

Notebook Screen

- 3 The TV screen appears on the laptop screen. The wireless environment may affect the screen display. If the connection is poor, the Intel WiDi connection may be lost.

* LG TVs do not need to register.

* For more information on Intel WiDi, visit '<http://intel.com/go/widi>'.

* You can control your PC using the Magic Remote. (above WiDi version 4.2)

Please call LG Customer Service if you experience any problems.